

OV99.30-Y-5800A	Contents	21.2.05
------------------------	-----------------	----------------

MODEL 903.662

AR	Testing and repair work	OV99.30-Y-5802AR
PE	Electric wiring diagrams	OV99.30-Y-5802PE

MODEL 903.662

	Electrical system, equipment and instruments	FG54	OV99.30-Y-5854AR
	Windows	FG67	OV99.30-Y-5867AR
	Interior equipment	FG68	OV99.30-Y-5868AR
	Doors	FG72	OV99.30-Y-5872AR
	Sliding roof, soft top, top attachments	FG77	OV99.30-Y-5877AR
	Electrical system body	FG82	OV99.30-Y-5882AR
	Climate control	FG83	OV99.30-Y-5883AR
	Emergency equipment, disabled equipment, sanitary equipment, galley	FG86	OV99.30-Y-5886AR
	Detachable body components, exterior flaps	FG88	OV99.30-Y-5888AR
	Seats, bunks, restraint systems	FG91	OV99.30-Y-5891AR

MODEL 903.662

	Electric wiring diagram for motor caravan	MODEL 903.662 with CODE (Z29) "James Cook" touring camper, NAFTA sheet 1	PE68.00-D-2000D
	Electric wiring diagram for motor caravan	MODEL 903.662 with CODE (Z29) "James Cook" touring camper, NAFTA sheet 2	PE68.00-D-2000E

OV99.30-Y-5854AR	Testing and repair work: Electrical system, equipment and instruments	21.2.05
------------------	---	---------

MODEL 903.662

	Removing, installing auxiliary battery	MODEL 903.662 with CODE (ZU8) National version for USA with CODE (Z29) "James Cook" touring camper, NAFTA	AR54.10-D-0007A
	Remove/install battery cover of additional batteries	MODEL 903.662 with CODE (ZU8) National version for USA with CODE (Z29) "James Cook" touring camper, NAFTA	AR54.10-D-0011A
	Remove/install 110 V outside socket	MODEL 903.662 with CODE (ZU8) National version for USA with CODE (Z29) "James Cook" touring camper, NAFTA	AR54.10-D-1019A
	Remove/install 110 V internal socket	MODEL 903.662 with CODE (ZU8) National version for USA with CODE (Z29) "James Cook" touring camper, NAFTA in longitudinal wall cupboard	AR54.10-D-1021A
	Remove/install 110 V internal socket	MODEL 903.662 with CODE (ZU8) National version for USA with CODE (Z29) "James Cook" touring camper, NAFTA on transverse wall cupboard	AR54.10-D-1021B
	Remove/install battery charger	MODEL 903.662 with CODE (ZU8) National version for USA with CODE (Z29) "James Cook" touring camper, NAFTA 110-V system for additional batteries	AR54.10-D-1040A
	Remove/install 110 V circuit breaker	MODEL 903.662 with CODE (ZU8) National version for USA with CODE (Z29) "James Cook" touring camper, NAFTA	AR54.15-D-0061A
	Remove/install fuse	MODEL 903.662 with CODE (ZU8) National version for USA with CODE (Z29) "James Cook" touring camper, NAFTA of the roof air conditioning control unit	AR54.15-D-1254A
	Remove/install fuse box	MODEL 903.662 with CODE (ZU8) National version for USA with CODE (Z29) "James Cook"	AR54.15-D-1256A

		touring camper, NAFTA on seat belt support	
	Remove web-type fuse	MODEL 903.662 with CODE (ZU8) National version for USA with CODE (Z29) "James Cook" touring camper, NAFTA The roof air conditioning on the switched-mode power supply	AR54.15-D-2100A
	Remove web-type fuse	MODEL 903.662 with CODE (ZU8) National version for USA with CODE (Z29) "James Cook" touring camper, NAFTA of the roof air conditioning in the engine compartment	AR54.15-D-2100B
	Remove/install central electronics	MODEL 903.662 with CODE (ZU8) National version for USA with CODE (Z29) "James Cook" touring camper, NAFTA	AR54.21-D-0019A
	Carry out self-test for central electronics	MODEL 903.662 with CODE (ZU8) National version for USA with CODE (Z29) "James Cook" touring camper, NAFTA	AR54.21-D-0021A
	Remove/install switched-mode power supply for roof air conditioning	MODEL 903.662 with CODE (ZU8) National version for USA with CODE (Z29) "James Cook" touring camper, NAFTA	AR54.21-D-0030A
	Remove/install vent for roof air conditioning switched-mode power supply	MODEL 903.662 with CODE (ZU8) National version for USA with CODE (Z29) "James Cook" touring camper, NAFTA	AR54.21-D-0031A
	Remove fill level indicator for excrement tank	MODEL 903.662 with CODE (ZU8) National version for USA with CODE (Z29) "James Cook" touring camper, NAFTA	AR54.30-D-6350A
	Remove/install smoke detector	MODEL 903.662 with CODE (ZU8) National version for USA with CODE (Z29) "James Cook" touring camper, NAFTA	AR54.65-D-0009A
	Remove/install CO-detector	MODEL 903.662 with CODE (ZU8) National version for USA with CODE (Z29) "James Cook" touring camper, NAFTA	AR54.65-D-0010A
	Remove/install gas detector	MODEL 903.662 with CODE (ZU8) National version for USA with CODE (Z29) "James Cook" touring camper, NAFTA	AR54.65-D-0011A



MODEL 903.662

	Remove/install side window between C and D-pillars	MODEL 903.662 with CODE (ZU8) National version for USA with CODE (Z29) "James Cook" touring camper, NAFTA	AR67.30-D-2301A
	Remove/install side window	MODEL 903.662 with CODE (ZU8) National version for USA with CODE (Z29) "James Cook" touring camper, NAFTA On right sliding door	AR67.30-D-2305A
	Remove/install vent window	MODEL 903.662 with CODE (ZU8) National version for USA with CODE (Z29) "James Cook" touring camper, NAFTA High roof side vent window	AR67.30-D-5213A
	Remove/install left center vent window	MODEL 903.662 with CODE (ZU8) National version for USA with CODE (Z29) "James Cook" touring camper, NAFTA	AR67.30-D-5214A
	Remove/install sealing frame for vent window	MODEL 903.662 with CODE (ZU8) National version for USA with CODE (Z29) "James Cook" touring camper, NAFTA Side high roof vent window	AR67.30-D-7731A
	Remove/install sealing frame for vent window	MODEL 903.662 with CODE (ZU8) National version for USA with CODE (Z29) "James Cook" touring camper, NAFTA Left bottom center vent window	AR67.30-D-7731B
	Remove/install arrester for vent window	MODEL 903.662 with CODE (ZU8) National version for USA with CODE (Z29) "James Cook" touring camper, NAFTA	AR67.30-D-8411A
	Remove/install vent window support	MODEL 903.662 with CODE (ZU8) National version for USA with CODE (Z29) "James Cook" touring camper, NAFTA	AR67.30-D-8415A

MODEL 903.662

	Remove/install cupholder	MODEL 903.662 with CODE (ZU8) National version for USA with CODE (Z29) "James Cook" touring camper, NAFTA left paneling	AR68.00-D-1000A
	Remove/install platform floor	MODEL 903.662 with CODE (ZU8) National version for USA with CODE (Z29) "James Cook" touring camper, NAFTA	AR68.20-D-2080A
	Remove/install folding table	MODEL 903.662 with CODE (ZU8) National version for USA with CODE (Z29) "James Cook" touring camper, NAFTA Side wall paneling folding table	AR68.20-D-8305A
	Remove/install folding table support	MODEL 903.662 with CODE (ZU8) National version for USA with CODE (Z29) "James Cook" touring camper, NAFTA Folding table support in side wall paneling	AR68.20-D-8306A
	Remove/install folding table hinge	MODEL 903.662 with CODE (ZU8) National version for USA with CODE (Z29) "James Cook" touring camper, NAFTA Folding table hinge in side wall paneling	AR68.20-D-8307A
	Remove/install table compartment strip	MODEL 903.662 with CODE (ZU8) National version for USA with CODE (Z29) "James Cook" touring camper, NAFTA	AR68.20-D-8310A
	Remove/install table compartment bracket	MODEL 903.662 with CODE (ZU8) National version for USA with CODE (Z29) "James Cook" touring camper, NAFTA	AR68.20-D-8311A
	Disassemble/assemble dining table	MODEL 903.662 with CODE (ZU8) National version for USA with CODE (Z29) "James Cook" touring camper, NAFTA	AR68.20-D-8320A
	Remove/install side wall lining	MODEL 903.662 with CODE (ZU8) National version for USA with CODE (Z29) "James Cook"	AR68.30-D-1450A

		touring camper, NAFTA Bottom side wall paneling	
	Remove/install side wall lining	MODEL 903.662 with CODE (ZU8) National version for USA with CODE (Z29) "James Cook" touring camper, NAFTA Top side wall lining	AR68.30-D-1450B
	Remove/install left center vent window paneling	MODEL 903.662 with CODE (ZU8) National version for USA with CODE (Z29) "James Cook" touring camper, NAFTA Bottom paneling	AR68.30-D-1510A
	Remove/install left center vent window trim	MODEL 903.662 with CODE (ZU8) Version for USA with CODE (Z29) "James Cook" touring camper, NAFTA Upper trim	AR68.30-D-1510B
	Remove/ install vent window paneling	MODEL 903.662 with CODE (ZU8) National version for USA with CODE (Z29) "James Cook" touring camper, NAFTA Side high roof vent window	AR68.30-D-1550A
	Remove/install vent window paneling luggage net	MODEL 903.662 with CODE (ZU8) National version for USA with CODE (Z29) "James Cook" touring camper, NAFTA Side high roof vent window	AR68.30-D-1560A
	Remove/install headliner	MODEL 903.662 with CODE (ZU8) National version for USA with CODE (Z29) "James Cook" touring camper, NAFTA	AR68.30-D-4300A
	Remove/install side roof frame paneling	MODEL 903.662 with CODE (ZU8) National version for USA with CODE (Z29) "James Cook" touring camper, NAFTA Above right sliding door	AR68.30-D-4480A
	Remove/install side roof frame paneling	MODEL 903.662 with CODE (ZU8) National version for USA with CODE (Z29) "James Cook" touring camper, NAFTA Above rear right side window	AR68.30-D-4480B
	Remove/install roof frame trim strip	MODEL 903.662 with CODE (ZU8) National version for USA with CODE (Z29) "James Cook" touring camper, NAFTA	AR68.30-D-4485A
	Remove/install paneling on C-	MODEL 903.662 with CODE	AR68.30-D-

	pillar	(ZU8) National version for USA with CODE (Z29) "James Cook" touring camper, NAFTA Right side	4490A
	Remove/install roller sun blind	MODEL 903.662 with CODE (ZU8) Version for USA with CODE (Z29) "James Cook" touring camper, NAFTA On left center vent window	AR68.50-D-3400A
	Remove/install roller sun blind	MODEL 903.662 with CODE (ZU8) National version for USA with CODE (Z29) "James Cook" touring camper, NAFTA on right rear side window	AR68.50-D-3400B
	Remove/ install roller sun blind	MODEL 903.662 with CODE (ZU8) National version for USA with CODE (Z29) "James Cook" touring camper, NAFTA on right sliding door	AR68.50-D-3400C
	Remove/ install roller sun blind	MODEL 903.662 with CODE (ZU8) National version for USA with CODE (Z29) "James Cook" touring camper, NAFTA Side high roof vent window	AR68.50-D-3400D
	Adjust roller sun blind	MODEL 903.662 with CODE (ZU8) National version for USA with CODE (Z29) "James Cook" touring camper, NAFTA	AR68.50-D-3450A
	Remove/install valuables compartment	MODEL 903.662 with CODE (ZU8) National version for USA with CODE (Z29) "James Cook" touring camper, NAFTA in refrigerator box stowage cabinet	AR68.72-D-0020A
	Remove/install valuables compartment lock	MODEL 903.662 with CODE (ZU8) National version for USA with CODE (Z29) "James Cook" touring camper, NAFTA in refrigerator box stowage cabinet	AR68.72-D-0021A

MODEL 903.662

	Remove/install sliding door panel	MODEL 903.662 with CODE (ZU8) National version for USA with CODE (Z29) "James Cook" touring camper, NAFTA Upper door panel	AR72.16-D-6610A
	Remove/install rear-end door stowage compartment	MODEL 903.662 with CODE (ZU8) National version for USA with CODE (Z29) "James Cook" touring camper, NAFTA	AR72.20-D-1050A
	Disassemble/assemble rear-end door (left door wing)	MODEL 903.662 with CODE (ZU8) National version for USA with CODE (Z29) "James Cook" touring camper, NAFTA with CODE (W54) Double rear door opening 270 degrees	AR72.20-D-2401E
	Disassemble/assemble rear-end door (right door wing)	MODEL 903.662 with CODE (ZU8) National version for USA with CODE (Z29) "James Cook" touring camper, NAFTA with CODE (W54) Double rear-end door opening 270 degrees	AR72.20-D-2411E
	Install model plate on tailgate	MODEL 903.6 with CODE (ZU8) National version for USA with CODE (Z29) "James Cook" touring camper, NAFTA	AR72.20-D-3660A
	Remove/install door locking system for wet cell door*	MODEL 903.662 with CODE (ZU8) Version for USA with CODE (Z29) "James Cook" touring camper, NAFTA	AR72.40-D-4802A
	Remove/install door knob on wet cell door*	MODEL 903.662 with CODE (ZU8) Version for USA with CODE (Z29) "James Cook" touring camper, NAFTA	AR72.40-D-4803A

MODEL 903.662

	Remove lifting/tilting roof window	MODEL 903.662 with CODE (ZU8) National version for USA with CODE (Z29) "James Cook" touring camper, NAFTA with CODE (DL1) Electric lifting/tilting roof window, James Cook	AR77.55-D-5000A
	Remove lifting/tilting roof window	MODEL 903.662 with CODE (ZU8) National version for USA with CODE (Z29) "James Cook" touring camper, NAFTA Sanitary block	AR77.55-D-5000B
	Remove/install glass lifting/tilting roof window	MODEL 903.662 with CODE (ZU8) National version for USA with CODE (Z29) "James Cook" touring camper, NAFTA Sanitary block	AR77.55-D-5005B
	Remove/install lifting/tilting roof window sealing profile	MODEL 903.662 with CODE (ZU8) National version for USA with CODE (Z29) "James Cook" touring camper, NAFTA Sanitary block	AR77.55-D-5006B
	Remove/install lifting/tilting roof window lock	MODEL 903.662 with CODE (ZU8) National version for USA with CODE (Z29) "James Cook" touring camper, NAFTA Sanitary block	AR77.55-D-5007B
	Remove install lifting/tilting roof window blackout blind	MODEL 903.662 with CODE (ZU8) National version for USA with CODE (Z29) "James Cook" touring camper, NAFTA Sanitary block	AR77.55-D-5010B
	Remove/install fly protection screen for lifting/tilting roof window	MODEL 903.662 with CODE (ZU8) National version for USA with CODE (Z29) "James Cook" touring camper, NAFTA with CODE (DL1) Electric lifting/tilting roof window, James Cook	AR77.55-D-5020A
	Remove/install battery for lifting/tilting roof window remote control	MODEL 903.662 with CODE (ZU8) National version for USA with CODE (Z29) "James Cook"	AR77.55-D-5030A

		touring camper, NAFTA with CODE (DL1) Electric lifting/tilting roof window, James Cook	
	Install motor lifting/tilting roof window motor	MODEL 903.662 with CODE (ZU8) National version for USA with CODE (Z29) "James Cook" touring camper, NAFTA with CODE (DL1) Electric lifting/tilting roof window, James Cook	AR77.55-D-5040A
	Remove/install receiver for lifting/tilting roof window remote control	MODEL 903.662 with CODE (ZU8) National version for USA with CODE (Z29) "James Cook" touring camper, NAFTA with CODE (DL1) Electric lifting/tilting roof window, James Cook	AR77.55-D-5050A

MODEL 903.662

	Remove/install license plate lamps	MODEL 903.662 with CODE (ZU8) National version for USA with CODE (Z29) "James Cook" touring camper, NAFTA	AR82.10-D-5161A
	Remove/install center high-mounted stop lamp	MODEL 903.662 with CODE (ZU8) National version for USA with CODE (Z29) "James Cook" touring camper, NAFTA In raised roof	AR82.10-D-5375A
	Remove/install interior light switch	MODEL 903.662 with CODE (ZU8) National version for USA with CODE (Z29) "James Cook" touring camper, NAFTA interior light switch in longitudinal wall cupboard	AR82.20-D-1010A
	Remove/install interior light switch	MODEL 903.662 with CODE (ZU8) National version for USA with CODE (Z29) "James Cook" touring camper, NAFTA interior light switch for wet cell	AR82.20-D-1010AB
	Remove/install interior illumination switch for upper sliding door frame paneling	MODEL 903.662 with CODE (ZU8) National version for USA with CODE (Z29) "James Cook" touring camper, NAFTA	AR82.20-D-1011A
	Remove/install lamps for interior illumination on hang-on cabinet longitudinally	MODEL 903.662 with CODE (ZU8) National version for USA with CODE (Z29) "James Cook" touring camper, NAFTA	AR82.20-D-1012A
	Remove/install lamps for interior illumination on hang-on cabinet transversally	MODEL 903.662 with CODE (ZU8) National version for USA with CODE (Z29) "James Cook" touring camper, NAFTA	AR82.20-D-1013A
	Remove/install shower room's interior lamp.	MODEL 903.662 with CODE (ZU8) National version for USA with CODE (Z29) "James Cook" touring camper, NAFTA	AR82.20-D-1014A
	Remove/install lamp for left center vent window	MODEL 903.662 with CODE (ZU8) National version for USA with CODE (Z29) "James Cook" touring camper, NAFTA	AR82.20-D-1015A

	Remove/install bulb of shower room's interior lamp	MODEL 903.662 with CODE (ZU8) National version for USA with CODE (Z29) "James Cook" touring camper, NAFTA	AR82.20-D-1016A
	Remove/install lamp if raised roof vent window	MODEL 903.662 with CODE (ZU8) National version for USA with CODE (Z29) "James Cook" touring camper, NAFTA	AR82.20-D-1017A
	Remove/install speaker	MODEL 903.662 with CODE (ZU8) National version for USA with CODE (Z29) "James Cook" touring camper, NAFTA Speaker in raised roof	AR82.62-D-1100A

MODEL 903.662

	Remove, install ventilation screens	MODEL 903.662 with CODE (ZU8) National version for USA with CODE (Z29) "James Cook" touring camper, NAFTA On horizontal wall cabinet	AR83.10-D-0011A
	Removing and installing rear air nozzle	MODEL 903.662 with CODE (ZU8) National version for USA with CODE (Z29) "James Cook" touring camper, NAFTA In horizontal wall cabinet	AR83.10-D-4800A
	Removing/installing roof air conditioning on vehicle roof	MODEL 903.662 with CODE (ZU8) National version for USA with CODE (Z29) "James Cook" touring camper, NAFTA	AR83.30-D-1000A
	Remove/install cover for roof air conditioning on vehicle roof	MODEL 903.662 with CODE (ZU8) National version for USA with CODE (Z29) "James Cook" touring camper, NAFTA	AR83.30-D-1010A
	Draining, evacuating and refilling air conditioning, checking function and checking for leaks	MODEL 903.662 with CODE (ZU8) National version for USA with CODE (Z29) "James Cook" touring camper, NAFTA Roof air conditioning made by Kerstner, model 103K	AR83.30-D-1760C
	Remove/install air conditioning blower motor	MODEL 903.662 with CODE (ZU8) National version for USA with CODE (Z29) "James Cook" touring camper, NAFTA Roof air conditioning	AR83.30-D-5560A
	Remove/install the air conditioning's condenser fan (roof equipment)	MODEL 903.662 with CODE (ZU8) National version for USA with CODE (Z29) "James Cook" touring camper, NAFTA	AR83.50-D-5060B
	Remove/install condenser's temperature switch in the air conditioning (roof equipment)	MODEL 903.662 with CODE (ZU8) National version for USA with CODE (Z29) "James Cook" touring camper, NAFTA	AR83.50-D-5120A
	Remove/install control unit of air conditioning (roof equipment)	MODEL 903.662 with CODE (ZU8) National version for USA with CODE (Z29) "James Cook"	AR83.50-D-6020A

		touring camper, NAFTA	
	Remove/install the air conditioning relay (roof equipment)	MODEL 903.662 with CODE (ZU8) National version for USA with CODE (Z29) "James Cook" touring camper, NAFTA Roof air conditioning load relay at the switching power supply unit	AR83.50-D-6030A
	Remove/install the air conditioning relay (roof equipment)	MODEL 903.662 with CODE (ZU8) National version for USA with CODE (Z29) "James Cook" touring camper, NAFTA Roof air conditioning load relay at refrigerant compressor	AR83.50-D-6030B
	Remove/install air conditioning control console (roof equipment)	MODEL 903.662 with CODE (ZU8) National version for USA with CODE (Z29) "James Cook" touring camper, NAFTA Roof air conditioning	AR83.50-D-6040A
	Remove/install refrigerant compressor	MODEL 903.662 with CODE (ZU8) National version for USA with CODE (Z29) "James Cook" touring camper, NAFTA Roof air conditioning refrigerant compressor	AR83.55-D-5300C
	Remove/install refrigerant compressor vibration damper	MODEL 903.662 with CODE (ZU8) National version for USA with CODE (Z29) "James Cook" touring camper, NAFTA Refrigerant compressor of roof air conditioning	AR83.55-D-7690A
	Remove/install V-belt of refrigerant compressor	MODEL 903.662 with CODE (ZU8) National version for USA with CODE (Z29) "James Cook" touring camper, NAFTA	AR83.65-D-2060B
	Remove/install refrigerant compressor motor	MODEL 903.662 with CODE (ZU8) National version for USA with CODE (Z29) "James Cook" touring camper, NAFTA Roof air conditioning refrigerant compressor motor	AR83.65-D-2070B
	Remove/install air outlet	MODEL 903.662 with CODE (ZU8) National version for USA with CODE (Z29) "James Cook" touring camper, NAFTA Kitchen block air outlet	AR83.70-D-3000A
	Remove/install air outlet	MODEL 903.662 with CODE	AR83.70-D-

		(ZU8) National version for USA with CODE (Z29) "James Cook" touring camper, NAFTA Air outlet for seating	3000B
	Remove and install fuel metering pump	MODEL 903.662 with CODE (ZU8) National version for USA with CODE (Z29) "James Cook" touring camper, NAFTA	AR83.70-D-5652G
	Remove/install glow plug	MODEL 903.662 with CODE (ZU8) National version for USA with CODE (Z29) "James Cook" touring camper, NAFTA	AR83.70-D-5758E
	Remove and install auxiliary heater electronic control unit	MODEL 903.662 with CODE (ZU8) National version for USA with CODE (Z29) "James Cook" touring camper, NAFTA	AR83.70-D-5937G
	Remove/install auxiliary heater	MODEL 903.662 with CODE (ZU8) National version for USA with CODE (Z29) "James Cook" touring camper, NAFTA	AR83.70-D-5945A
	Remove/install temperature sensor	MODEL 903.662 with CODE (ZU8) National version for USA with CODE (Z29) "James Cook" touring camper, NAFTA	AR83.70-D-5975A
	Remove and install heater unit exhaust system	MODEL 903.662 with CODE (ZU8) National version for USA with CODE (Z29) "James Cook" touring camper, NAFTA	AR83.70-D-7000A

OV99.30-Y-5886AR	Testing and repair work: Emergency equipment, disabled equipment, sanitary equipment, galley	21.2.05
------------------	--	---------

MODEL 903.662

	Remove/install city water connection	MODEL 903.662 with CODE (ZU8) National version for USA with CODE (Z29) "James Cook" touring camper, NAFTA	AR86.30-D-0040A
	Remove/install city water connection pressure reducing valve	MODEL 903.662 with CODE (ZU8) National version for USA with CODE (Z29) "James Cook" touring camper, NAFTA	AR86.30-D-0041A
	Remove/install city water connection check valve	MODEL 903.662 with CODE (ZU8) National version for USA with CODE (Z29) "James Cook" touring camper, NAFTA	AR86.30-D-0042A
	Remove/install city water connection contact switch	MODEL 903.662 with CODE (ZU8) National version for USA with CODE (Z29) "James Cook" touring camper, NAFTA	AR86.30-D-0043A
	Remove/install hot water boiler	MODEL 903.662 with CODE (ZU8) National version for USA with CODE (Z29) "James Cook" touring camper, NAFTA	AR86.30-D-0050A
	Drain/fill hot water boiler	MODEL 903.662 with CODE (ZU8) National version for USA with CODE (Z29) "James Cook" touring camper, NAFTA	AR86.30-D-0051A
	Remove/install hot water boiler outside flap	MODEL 903.662 with CODE (ZU8) National version for USA with CODE (Z29) "James Cook" touring camper, NAFTA	AR86.30-D-0052A
	Remove/install fresh water tank	MODEL 903.662 with CODE (ZU8) National version for USA with CODE (Z29) "James Cook" touring camper, NAFTA	AR86.30-D-0060A
	Remove/install fresh water tank level sensor	MODEL 903.662 with CODE (ZU8) National version for USA with CODE (Z29) "James Cook" touring camper, NAFTA	AR86.30-D-0061A
	Remove/install water pump in fresh water tank	MODEL 903.662 with CODE (ZU8) National version for USA	AR86.30-D-0062A

		with CODE (Z29) "James Cook" touring camper, NAFTA	
	Remove/install fresh water filler neck	MODEL 903.662 with CODE (ZU8) National version for USA with CODE (Z29) "James Cook" touring camper, NAFTA	AR86.30-D-0063A
	Check fresh water system for leakage	MODEL 903.662 with CODE (ZU8) National version for USA with CODE (Z29) "James Cook" touring camper, NAFTA	AR86.30-D-0065A
	Remove/install high roof excrement tank ventilation	MODEL 903.662 with CODE (ZU8) National version for USA with CODE (Z29) "James Cook" touring camper, NAFTA	AR86.30-D-0068A
	Remove/install wastewater tank slide valve	MODEL 903.662 with CODE (ZU8) National version for USA with CODE (Z29) "James Cook" touring camper, NAFTA	AR86.30-D-0069A
	Remove/install wastewater tank	MODEL 903.662 with CODE (ZU8) National version for USA with CODE (Z29) "James Cook" touring camper, NAFTA	AR86.30-D-0070A
	Check sewer system for leakage	MODEL 903.662 with CODE (ZU8) National version for USA with CODE (Z29) "James Cook" touring camper, NAFTA	AR86.30-D-0071A
	Remove/install wastewater tank water level sensor	MODEL 903.662 with CODE (ZU8) Version for USA with CODE (Z29) "James Cook" touring camper, NAFTA	AR86.30-D-0072A
	Remove/install excrement tank	MODEL 903.662 with CODE (ZU8) National version for USA with CODE (Z29) "James Cook" touring camper, NAFTA	AR86.30-D-0073A
	Remove/install toilet	MODEL 903.662 with CODE (ZU8) National version for USA with CODE (Z29) "James Cook" touring camper, NAFTA	AR86.30-D-0074A
	Remove/install excrement tank water level sensor	MODEL 903.662 with CODE (ZU8) National version for USA with CODE (Z29) "James Cook" touring camper, NAFTA	AR86.30-D-0075A
	Remove/install toilet flushing handle	MODEL 903.662 with CODE (ZU8) Version for USA with CODE (Z29) "James Cook"	AR86.30-D-0076A

		touring camper, NAFTA	
	Remove/install toilet cover	MODEL 903.662 with CODE (ZU8) Version for USA with CODE (Z29) "James Cook" touring camper, NAFTA	AR86.30-D-0077A
	Remove/install sanitary block outlet cover	MODEL 903.662 with CODE (ZU8) Version for USA with CODE (Z29) "James Cook" touring camper, NAFTA	AR86.30-D-0078A
	Remove/install sewer water connection ventilation valve in sanitary block wash basin	MODEL 903.662 with CODE (ZU8) National version for USA with CODE (Z29) "James Cook" touring camper, NAFTA	AR86.30-D-0079A
	Remove/install sanitary block shower head	MODEL 903.662 with CODE (ZU8) National version for USA with CODE (Z29) "James Cook" touring camper, NAFTA	AR86.30-D-0080A
	Remove/install sanitary block mirror	MODEL 903.662 with CODE (ZU8) National version for USA with CODE (Z29) "James Cook" touring camper, NAFTA	AR86.30-D-0081A
	Remove/install sanitary block shower head bracket	MODEL 903.662 with CODE (ZU8) Version for USA with CODE (Z29) "James Cook" touring camper, NAFTA	AR86.30-D-0082A
	Remove/install sanitary block towel holder	MODEL 903.662 with CODE (ZU8) Version for USA with CODE (Z29) "James Cook" touring camper, NAFTA	AR86.30-D-0083A
	Remove/install toilet water module	MODEL 903.662 with CODE (ZU8) National version for USA with CODE (Z29) "James Cook" touring camper, NAFTA	AR86.30-D-0084A
	Remove/install toilet top section	MODEL 903.662 with CODE (ZU8) National version for USA with CODE (Z29) "James Cook" touring camper, NAFTA	AR86.30-D-0085A
	Remove/install toilet slide	MODEL 903.662 with CODE (ZU8) National version for USA with CODE (Z29) "James Cook" touring camper, NAFTA	AR86.30-D-0086A
	Remove/install extendable clothes line	MODEL 903.662 with CODE (ZU8) National version for USA with CODE (Z29) "James Cook" touring camper, NAFTA	AR86.30-D-0090A

	Remove/install shower tray	MODEL 903.662 with CODE (ZU8) National version for USA with CODE (Z29) "James Cook" touring camper, NAFTA	AR86.30-D-0100A
	Remove/install kitchen element	MODEL 903.662 with CODE (ZU8) National version for USA with CODE (Z29) "James Cook" touring camper, NAFTA	AR86.60-D-0001A
	Remove/install sanitary block wash basin	MODEL 903.662 with CODE (ZU8) National version for USA with CODE (Z29) "James Cook" touring camper, NAFTA	AR86.60-D-0009A
	Remove/install hot water heater/sink combination	MODEL 903.662 with CODE (ZU8) National version for USA with CODE (Z29) "James Cook" touring camper, NAFTA	AR86.60-D-0010A
	Remove/install boiler/sink combination cover	MODEL 903.662 with CODE (ZU8) National version for USA with CODE (Z29) "James Cook" touring camper, NAFTA	AR86.60-D-0011A
	Remove/install heat shield on cooker	MODEL 903.662 with CODE (ZU8) National version for USA with CODE (Z29) "James Cook" touring camper, NAFTA	AR86.60-D-0012A
	Remove/install range hood	MODEL 903.662 with CODE (ZU8) National version for USA with CODE (Z29) "James Cook" touring camper, NAFTA	AR86.60-D-0017A
	Remove/install forced ventilation in kitchen	MODEL 903.662 with CODE (ZU8) National version for USA with CODE (Z29) "James Cook" touring camper, NAFTA	AR86.60-D-0018A
	Remove/install range hood ventilation	MODEL 903.662 with CODE (ZU8) National version for USA with CODE (Z29) "James Cook" touring camper, NAFTA	AR86.60-D-0019A
	Remove/install drawer	MODEL 903.662 with CODE (ZU8) Version for USA with CODE (Z29) "James Cook" touring camper, NAFTA	AR86.60-D-0020A
	Remove/install drawer rail	MODEL 903.662 with CODE (ZU8) National version for USA with CODE (Z29) "James Cook" touring camper, NAFTA	AR86.60-D-0021A
	Remove/install utensil insert	MODEL 903.662 with CODE	AR86.60-D-

		(ZU8) National version for USA with CODE (Z29) "James Cook" touring camper, NAFTA	0022A
	Remove/install drawer/flap lock	MODEL 903.662 with CODE (ZU8) National version for USA with CODE (Z29) "James Cook" touring camper, NAFTA	AR86.60-D-0025A
	Remove/install retractable cover handle	MODEL 903.662 with CODE (ZU8) National version for USA with CODE (Z29) "James Cook" touring camper, NAFTA	AR86.60-D-0027A
	Remove/install retractable cover lock	MODEL 903.662 with CODE (ZU8) National version for USA with CODE (Z29) "James Cook" touring camper, NAFTA Cooling box stowage cabinet	AR86.60-D-0028A
	Remove/install retractable cover below sanitary block wash basin	MODEL 903.662 with CODE (ZU8) National version for USA with CODE (Z29) "James Cook" touring camper, NAFTA	AR86.60-D-0029A
	Remove/install retractable cover on cabinet	MODEL 903.662 with CODE (ZU8) National version for USA with CODE (Z29) "James Cook" touring camper, NAFTA Cooling box stowage cabinet	AR86.60-D-0031A
	Remove/install retraceable cover on cabinet	MODEL 903.662 with CODE (ZU8) National version for USA with CODE (Z29) "James Cook" touring camper, NAFTA Longitudinal hanging cabinet	AR86.60-D-0031B
	Remove/install fastening strip for table	MODEL 903.662 with CODE (ZU8) Version for USA with CODE (Z29) "James Cook" touring camper, NAFTA	AR86.60-D-0033A
	Remove/install stowage cabinet	MODEL 903.662 with CODE (ZU8) National version for USA with CODE (Z29) "James Cook" touring camper, NAFTA refrigerator box	AR86.60-D-0045A
	Remove/install hanging cabinet	MODEL 903.662 with CODE (ZU8) National version for USA with CODE (Z29) "James Cook" touring camper, NAFTA lateral hanging cabinet	AR86.60-D-0051A
	Remove/install hanging cabinet	MODEL 903.662 with CODE (ZU8) National version for USA	AR86.60-D-0051B

		with CODE (Z29) "James Cook" touring camper, NAFTA Longitudinal hanging cabinet	
	Remove/install wardrobe storage shelf	MODEL 903.662 with CODE (ZU8) National version for USA with CODE (Z29) "James Cook" touring camper, NAFTA	AR86.60-D-0061A
	Remove/install wardrobe flap	MODEL 903.662 with CODE (ZU8) National version for USA with CODE (Z29) "James Cook" touring camper, NAFTA Front flap	AR86.60-D-0062A
	Remove/install wardrobe flap	MODEL 903.662 with CODE (ZU8) National version for USA with CODE (Z29) "James Cook" touring camper, NAFTA Rear flap	AR86.60-D-0062B
	Remove/install wardrobe clothes rail	MODEL 903.662 with CODE (ZU8) National version for USA with CODE (Z29) "James Cook" touring camper, NAFTA	AR86.60-D-0063A
	Remove/install sink water tap	MODEL 903.662 with CODE (ZU8) National version for USA with CODE (Z29) "James Cook" touring camper, NAFTA	AR86.60-D-0070A
	Remove/install syphon	MODEL 903.662 with CODE (ZU8) Version for USA with CODE (Z29) "James Cook" touring camper, NAFTA hot water heater/sink combination	AR86.60-D-0071A
	Remove/install waste trap for shower tray	MODEL 903.662 with CODE (ZU8) Version for USA with CODE (Z29) "James Cook" touring camper, NAFTA	AR86.60-D-0072A
	Remove/install sanitary block wash basin water tap	MODEL 903.662 with CODE (ZU8) National version for USA with CODE (Z29) "James Cook" touring camper, NAFTA	AR86.60-D-0073A
	Remove/install gas shut-off cock	MODEL 903.662 with CODE (ZU8) National version for USA with CODE (Z29) "James Cook" touring camper, NAFTA	AR86.60-D-0085A
	Perform leakage test for gas system	MODEL 903.662 with CODE (ZU8) National version for USA with CODE (Z29) "James Cook" touring camper, NAFTA	AR86.60-D-0100A

	Remove/install compressed-gas tank	MODEL 903.662 with CODE (ZU8) National version for USA with CODE (Z29) "James Cook" touring camper, NAFTA	AR86.60-D-0110A
	Remove/install compressed-gas tank	MODEL 903.662 with CODE (ZU8) National version for USA with CODE (Z29) "James Cook" touring camper, NAFTA	AR86.60-D-0120A
	Remove/install compressed-gas tank fill level indicator	MODEL 903.662 with CODE (ZU8) National version for USA with CODE (Z29) "James Cook" touring camper, NAFTA	AR86.60-D-0130A
	Remove/install pressure reducing valve	MODEL 903.662 with CODE (ZU8) National version for USA with CODE (Z29) "James Cook" touring camper, NAFTA On compressed-gas tank	AR86.60-D-0140A
	Remove/install cover gasket for refrigerator box	MODEL 903.662 with CODE (ZU8) National version for USA with CODE (Z29) "James Cook" touring camper, NAFTA	AR86.61-D-0052A
	Remove/install kitchen element refrigerator box cover arrester	MODEL 903.662 with CODE (ZU8) National version for USA with CODE (Z29) "James Cook" touring camper, NAFTA	AR86.61-D-0053A
	Remove/install refrigerator box cover lock	MODEL 903.662 with CODE (ZU8) National version for USA with CODE (Z29) "James Cook" touring camper, NAFTA	AR86.61-D-0054A
	Remove/install refrigerator box temperature sensor	MODEL 903.662 with CODE (ZU8) National version for USA with CODE (Z29) "James Cook" touring camper, NAFTA	AR86.61-D-0056A
	Remove/install refrigerator box cover	MODEL 903.662 with CODE (ZU8) National version for USA with CODE (Z29) "James Cook" touring camper, NAFTA	AR86.61-D-1002A
	Remove/install refrigerator box cover	MODEL 903.662 with CODE (ZU8) National version for USA with CODE (Z29) "James Cook" touring camper, NAFTA	AR86.61-D-1003A
	Remove/install refrigerator box	MODEL 903.662 with CODE (ZU8) National version for USA with CODE (Z29) "James Cook" touring camper, NAFTA	AR86.61-D-1010A

	Remove/install tachometer for refrigerator compressor	MODEL 903.662 with CODE (ZU8) National version for USA with CODE (Z29) "James Cook" touring camper, NAFTA	AR86.61-D-1035A
	Remove/install refrigerator box control unit	MODEL 903.662 with CODE (ZU8) National version for USA with CODE (Z29) "James Cook" touring camper, NAFTA	AR86.61-D-1050A
	Remove/install refrigerator box fan	MODEL 903.662 with CODE (ZU8) National version for USA with CODE (Z29) "James Cook" touring camper, NAFTA	AR86.61-D-1070A

OV99.30-Y-5888AR	Testing and repair work: Detachable body components, exterior flaps	21.2.05
------------------	---	---------

MODEL 903.662

	Remove/install window covering	MODEL 903.662 with CODE (ZU8) National version for USA with CODE (Z29) "James Cook" touring camper, NAFTA Left side wall	AR88.00-D-1360A
	Remove/install window covering	MODEL 903.662 with CODE (ZU8) National version for USA with CODE (Z29) "James Cook" touring camper, NAFTA Rear door window cover	AR88.00-D-1360AB

MODEL 903.662

	Remove/install driver's seat	MODEL 903.662 with CODE (ZU8) National version for USA with CODE (Z29) "James Cook" touring camper, NAFTA	AR91.10-D-1010B
	Remove/install passenger seat	MODEL 903.662 with CODE (ZU8) National version for USA with CODE (Z29) "James Cook" touring camper, NAFTA	AR91.10-D-1020B
	Remove/install trim panel at the seat frame	MODEL 903.662 with CODE (ZU8) National version for USA with CODE (Z29) "James Cook" touring camper, NAFTA driver seat	AR91.10-D-1056A
	Remove/install the rear cover on driver seat	MODEL 903.662 with CODE (ZU8) National version for USA with CODE (Z29) "James Cook" touring camper, NAFTA	AR91.10-D-1065A
	Remove/install driver seat turntable	MODEL 903.662 with CODE (ZU8) National version for USA with CODE (Z29) "James Cook" touring camper, NAFTA	AR91.10-D-1455A
	Remove/install seat cushion	MODEL 903.662 with CODE (ZU8) National version for USA with CODE (Z29) "James Cook" touring camper, NAFTA front seats	AR91.10-D-3310A
	Remove/install backrest	MODEL 903.662 with CODE (ZU8) National version for USA with CODE (Z29) "James Cook" touring camper, NAFTA	AR91.10-D-3325A
	Remove/install armrest	MODEL 903.662 with CODE (ZU8) National version for USA with CODE (Z29) "James Cook" touring camper, NAFTA	AR91.10-D-3326A
	Remove/install seat rails at front seat	MODEL 903.662 with CODE (ZU8) National version for USA with CODE (Z29) "James Cook" touring camper, NAFTA Driver seat	AR91.10-D-7402A

	Remove and install bench	MODEL 903.662 with CODE (ZU8) National version for USA with CODE (Z29) "James Cook" touring camper, NAFTA	AR91.21-D-4000A
	Remove/install bench seat casing	MODEL 903.662 with CODE (ZU8) National version for USA with CODE (Z29) "James Cook" touring camper, NAFTA	AR91.21-D-4010A
	Remove/install bench seat armrest	MODEL 903.662 with CODE (ZU8) National version for USA with CODE (Z29) "James Cook" touring camper, NAFTA	AR91.21-D-4020A
	Remove/install backrest fitting	MODEL 903.662 with CODE (ZU8) National version for USA with CODE (Z29) "James Cook" touring camper, NAFTA	AR91.21-D-4030A
	Remove/install bench seat sliding block	MODEL 903.662 with CODE (ZU8) National version for USA with CODE (Z29) "James Cook" touring camper, NAFTA Front sliding block	AR91.21-D-4040A
	Remove/install bench seat sliding block	MODEL 903.662 with CODE (ZU8) National version for USA with CODE (Z29) "James Cook" touring camper, NAFTA Rear sliding block	AR91.21-D-4040B
	Remove/install adjustment lever on bench seat	MODEL 903.662 with CODE (ZU8) National version for USA with CODE (Z29) "James Cook" touring camper, NAFTA	AR91.21-D-4050A
	Remove/install bench seat adjustment Bowden cable	MODEL 903.662 with CODE (ZU8) National version for USA with CODE (Z29) "James Cook" touring camper, NAFTA Right Bowden cable	AR91.21-D-4060A
	Remove/install bench seat adjustment Bowden cable	MODEL 903.662 with CODE (ZU8) National version for USA with CODE (Z29) "James Cook" touring camper, NAFTA Left Bowden cable	AR91.21-D-4060B
	Remove/install rabbet	MODEL 903.662 with CODE (ZU8) National version for USA with CODE (Z29) "James Cook" touring camper, NAFTA	AR91.21-D-4070A
	Remove/install lock plate	MODEL 903.662 with CODE (ZU8) National version for USA	AR91.21-D-4080A

		with CODE (Z29) "James Cook" touring camper, NAFTA	
	Remove/install protective plate	MODEL 903.662 with CODE (ZU8) National version for USA with CODE (Z29) "James Cook" touring camper, NAFTA	AR91.21-D-4090A
	Remove/install index bolt for bench seat adjustment	MODEL 903.662 with CODE (ZU8) National version for USA with CODE (Z29) "James Cook" touring camper, NAFTA	AR91.21-D-4100A
	Remove/install rubber damper	MODEL 903.662 with CODE (ZU8) National version for USA with CODE (Z29) "James Cook" touring camper, NAFTA	AR91.21-D-4110A
	Remove/install support	MODEL 903.662 with CODE (ZU8) National version for USA with CODE (Z29) "James Cook" touring camper, NAFTA	AR91.21-D-4120A
	Remove/install back cushion on bench seat	MODEL 903.662 with CODE (ZU8) National version for USA with CODE (Z29) "James Cook" touring camper, NAFTA	AR91.21-D-4495A
	Remove/install seat bolster on bench seat	MODEL 903.662 with CODE (ZU8) National version for USA with CODE (Z29) "James Cook" touring camper, NAFTA	AR91.21-D-4505A
	Remove/install notch lever for seat bolster	MODEL 903.662 with CODE (ZU8) National version for USA with CODE (Z29) "James Cook" touring camper, NAFTA	AR91.21-D-4506A
	Remove/install front panel on bench seat housing	MODEL 903.662 with CODE (ZU8) National version for USA with CODE (Z29) "James Cook" touring camper, NAFTA	AR91.21-D-5745A
	Remove/install panel at right side on bench seat housing	MODEL 903.662 with CODE (ZU8) National version for USA with CODE (Z29) "James Cook" touring camper, NAFTA	AR91.21-D-5746A
	Remove/install heated seat switch	MODEL 903.662 with CODE (ZU8) National version for USA with CODE (Z29) "James Cook" touring camper, NAFTA with CODE (H15) Heater for front passenger seat with CODE (H16) Heater for driver seat	AR91.30-D-0080A

	Remove/install seat belt on bench seat	MODEL 903.662 with CODE (ZU8) National version for USA with CODE (Z29) "James Cook" touring camper, NAFTA Center and right seat belts	AR91.40-D-1035A
	Remove/install seat belt on bench seat	MODEL 903.662 with CODE (ZU8) National version for USA with CODE (Z29) "James Cook" touring camper, NAFTA Left seat belt	AR91.40-D-1035B
	Seat belt buckle for bench seat	MODEL 903.662 with CODE (ZU8) National version for USA with CODE (Z29) "James Cook" touring camper, NAFTA	AR91.40-D-1490A
	Remove/install seat belt buckle	MODEL 903.662 with CODE (ZU8) National version for USA with CODE (Z29) "James Cook" touring camper, NAFTA	AR91.40-D-1517A
	Removing and installing bed extension	MODEL 903.662 with CODE (ZU8) National version for USA with CODE (Z29) "James Cook" touring camper, NAFTA	AR91.75-D-0010A
	Remove/install support brace for bed extension	MODEL 903.662 with CODE (ZU8) National version for USA with CODE (Z29) "James Cook" touring camper, NAFTA	AR91.75-D-0011A
	Remove/install clamping device	MODEL 903.662 with CODE (ZU8) National version for USA with CODE (Z29) "James Cook" touring camper, NAFTA Bench seat	AR91.75-D-0012A
	Remove/install bed individual suspension module in raised roof	MODEL 903.662 with CODE (ZU8) National version for USA with CODE (Z29) "James Cook" touring camper, NAFTA	AR91.75-D-7610A
	Remove/install protective net	MODEL 903.662 with CODE (ZU8) National version for USA with CODE (Z29) "James Cook" touring camper, NAFTA	AR91.75-D-7730A
	Remove/install bracket for protective net	MODEL 903.662 with CODE (ZU8) National version for USA with CODE (Z29) "James Cook" touring camper, NAFTA protective net for high roof bed	AR91.75-D-7735A
	Remove/install bed plate	MODEL 903.662 with CODE (ZU8) National version for USA	AR91.75-D-7755A

		with CODE (Z29) "James Cook" touring camper, NAFTA rear bed plate	
	Remove/install bed plate	MODEL 903.662 with CODE (ZU8) National version for USA with CODE (Z29) "James Cook" touring camper, NAFTA center bed plate	AR91.75-D-7755B
	Remove/install bed plate	MODEL 903.662 with CODE (ZU8) National version for USA with CODE (Z29) "James Cook" touring camper, NAFTA front bed plate	AR91.75-D-7755C
	Remove/install locking mechanism for bed plate	MODEL 903.662 with CODE (ZU8) National version for USA with CODE (Z29) "James Cook" touring camper, NAFTA center bed plate	AR91.75-D-7756A
	Remove/install protective strip for bed plate	MODEL 903.662 with CODE (ZU8) National version for USA with CODE (Z29) "James Cook" touring camper, NAFTA center bed plate	AR91.75-D-7757A
	Remove/install guide roller for bed plate	MODEL 903.662 with CODE (ZU8) National version for USA with CODE (Z29) "James Cook" touring camper, NAFTA	AR91.75-D-7760A
	Remove/install guide rail for bed plate	MODEL 903.662 with CODE (ZU8) National version for USA with CODE (Z29) "James Cook" touring camper, NAFTA left guide rail	AR91.75-D-7765A
	Remove/install guide rail for bed plate	MODEL 903.662 with CODE (ZU8) National version for USA with CODE (Z29) "James Cook" touring camper, NAFTA right guide rail	AR91.75-D-7765B

PE68.00-D-2000D	Wiring diagram for camper	29.9.04
------------------------	----------------------------------	----------------

MODEL 903.662 with CODE (Z29) "James Cook" touring camper, NAFTA
Sheet 1

PE68.00-D-2000-99D	Wiring diagram for camper	Sheet 1	PE68.00-D-2000-99D
PE68.00-D-2000-60D	Legend of wiring diagram for camper	Sheet 1	PE68.00-D-2000-60D
OV00.01-N-1901-03D	Use of wiring diagrams		OV00.01-N-1901-03D
OV00.01-N-1901E	Search aid for all wiring diagram groups		OV00.01-N-1901E
OV00.01-N-1001-27E	Abbreviations for wiring diagrams		OV00.01-N-1001-27E
GF00.19-D-2000D	Location and assignment of ground points		GF00.19-D-2000D
PE15.00-D-1100D	Overview of wiring diagrams for electrical system, engine	Further wiring diagrams	PE15.00-D-1100D
PE83.00-D-1100D	Overview of wiring diagrams for climate control	Further wiring diagrams	PE83.00-D-1100D

PE68.00-D-2000E	Wiring diagram for camper	29.9.04
------------------------	----------------------------------	----------------

MODEL 903.662 with CODE (Z29) "James Cook" touring camper, NAFTA
Sheet 2

PE68.00-D-2000-99E	Wiring diagram for camper	Sheet 2	PE68.00-D-2000-99E
PE68.00-D-2000-60E	Legend of wiring diagram for camper	Sheet 2	PE68.00-D-2000-60E
OV00.01-N-1901-03D	Use of wiring diagrams		OV00.01-N-1901-03D
OV00.01-N-1901E	Search aid for all wiring diagram groups		OV00.01-N-1901E
OV00.01-N-1001-27E	Abbreviations for wiring diagrams		OV00.01-N-1001-27E
GF00.19-D-2000D	Location and assignment of ground points		GF00.19-D-2000D

MODEL 903.662

with CODE (ZU8) National version for USA

with CODE (Z29) "James Cook" touring camper, NAFTA

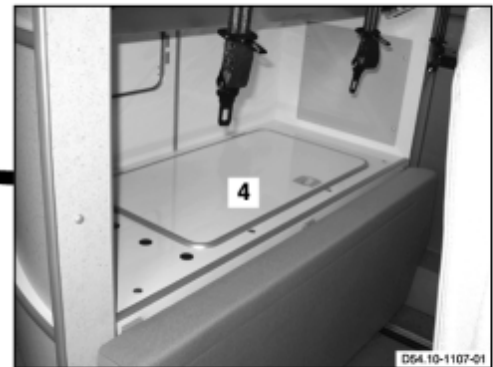
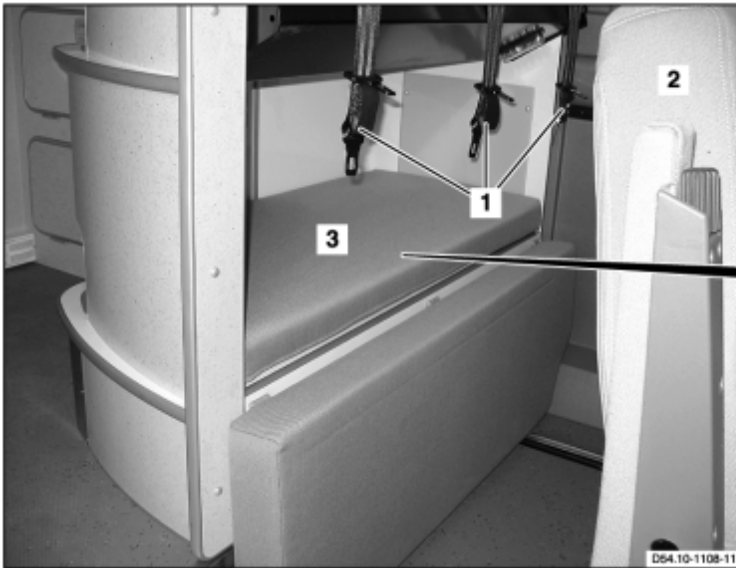

D54.10-1109-08

1 Seat belts
2 Bench seat

3 Padding
4 Cover

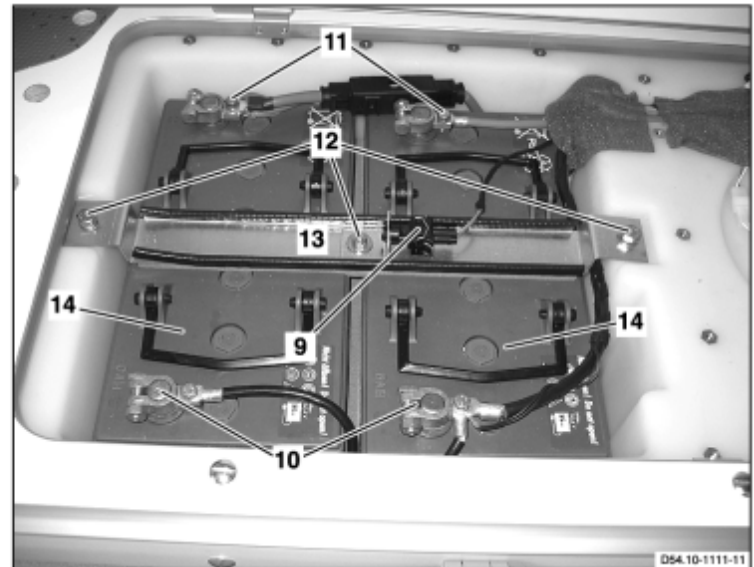
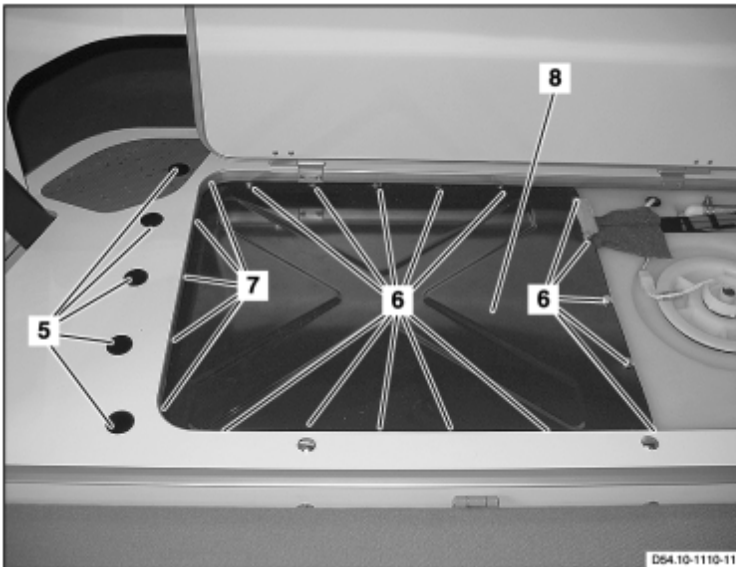





D54.10-1112-08

5 Plug
6 Bolts
7 Bolts
8 Cover

9 Clutch
10 Ground cables
11 Positive leads

12 Bolts
13 Bracket
14 Batteries

	Remove/Install		
 Danger!	Risk of injury caused by scraping or cutting body parts on sharp vehicle parts	Always wear protective gloves when working on or near sharp and non-deburred vehicle parts. Deburr repair panels.	AS00.00-Z-0017-01B
 Danger!	Risk of explosion caused by oxyhydrogen gas. Risk of poisoning and caustic burns caused by swallowing battery acid. Risk of injury through burns to skin and eyes from battery acid or when handling damaged lead-acid batteries	No fire, sparks, open flames or smoking. Wear acid-resistant gloves, clothing and safety glasses. Pour battery acid only into suitable and appropriately marked containers.	AS54.10-Z-0001-01A
	Notes on battery	All models	AH54.10-P-0001-01A
1	Unlock seat belts (1) from the seat belt buckles		
2	Move the bench seat (2) forwards		
3	Remove upholstery (3)		
4	Fold out cover (4)		
5	Take out plug (5)		
6	Remove bolts (6)		
7	Loosen bolts (7)		
8	Move cover (8) to the right and take out		
9	Detach coupling (9) of temperature sensor		
10	Disconnect ground lines (10)		
11	Disconnect positive leads (11)		
12	Remove bolts (12)		
13	Take out bracket (13)		
14	Take out batteries (14)		
15	Install in the reverse order		
16	Check voltage of the batteries (14) via the electrical center		

MODEL 903.662

with CODE (ZU8) National version for USA

with CODE (Z29) "James Cook" touring camper, NAFTA

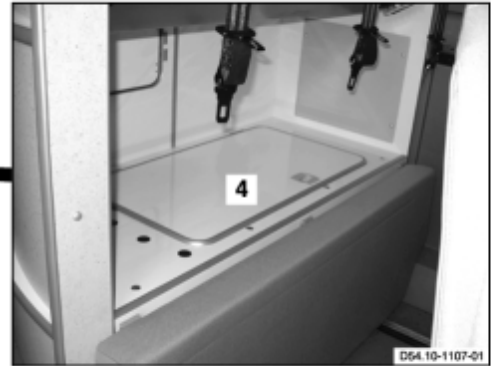
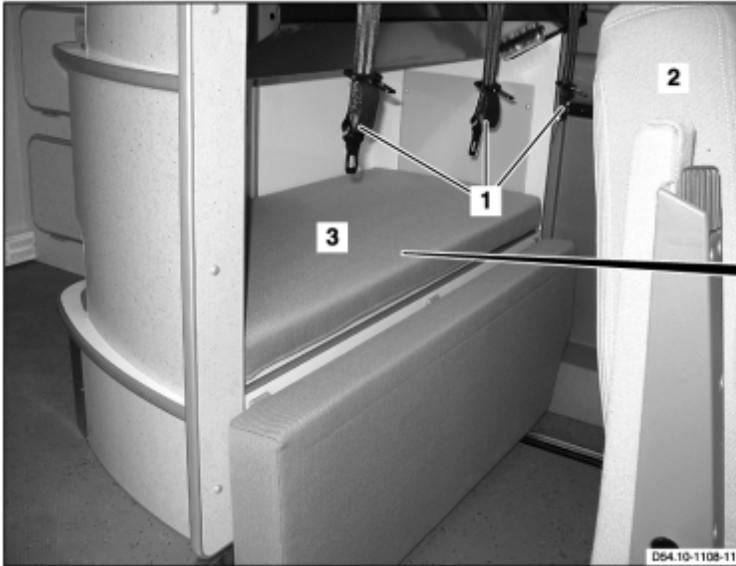

D54.10-1109-08

1 Seat belts
2 Bench seat

3 Padding
4 Cover

5 Plug
6 Bolts
7 Bolts
8 Cover

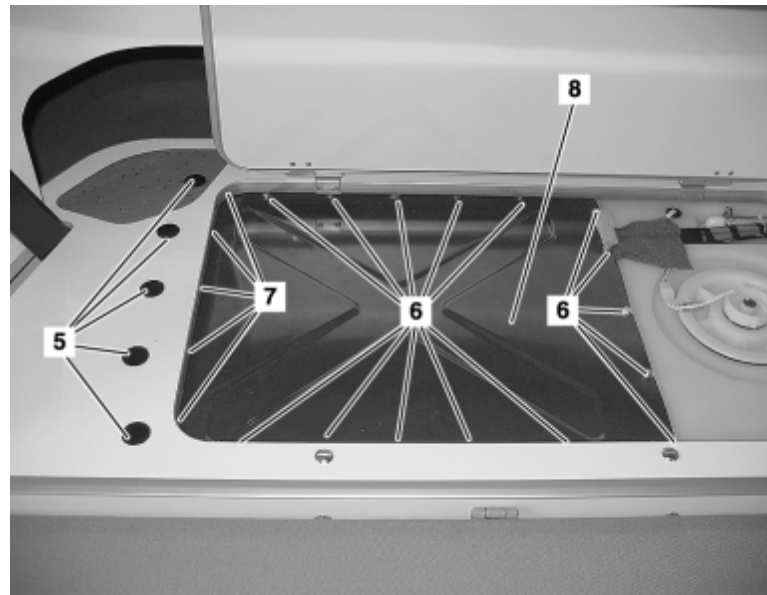

D54.10-1110-11

	<p>Remove/Install</p>		
<p>⚠ Danger!</p>	<p>Risk of explosion caused by oxyhydrogen gas. Risk of poisoning and caustic burns</p>	<p>No fire, sparks, open flames or smoking. Wear acid-resistant gloves, clothing and safety</p>	<p>AS54.10-Z-0001-01A</p>

	caused by swallowing battery acid. Risk of injury caused by burns to skin and eyes from battery acid or when handling damaged lead-acid batteries	glasses. Pour battery acid only into suitable and appropriately marked containers.	
1	Unlatch seat belts (1) from the seat belt buckles		
2	Move bench seat (2) forwards		
3	Remove upholstery (3)		
4	Fold out cover (4)		
5	Remove plug (5)		
6	Remove screws (6)		
7	Loosen screws (7)		
8	Move cover (8) to the right and take out		
9	Install in the reverse order		

MODEL 903.662

with CODE (ZU8) National version for USA

with CODE (Z29) "James Cook" touring camper, NAFTA

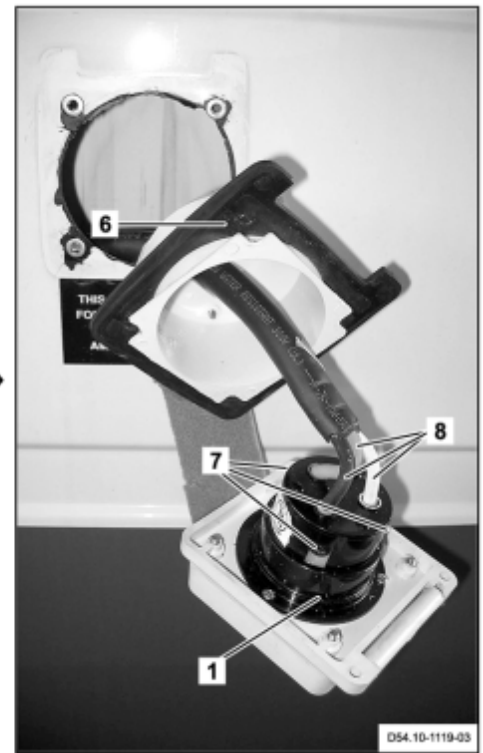

D54.10-1120-09

1 110 V outside socket
2 Bolts
3 Foam pad

4 Bolts
5 Clamping bracket
6 Rear housing

7 Bolts
8 Electrical wiring

☒ ☒	Remove/Install		
⚠ Danger!	Risk of death from coming into contact with electrical parts of the 110 V system Risk of injury from burns which may be caused by electric shock or by current flowing directly through parts of the body.	Do not touch voltage conducting parts in the 110 V system.	AS00.00-Z-0027-01A
1	Disconnect external 110 V feed line from vehicle	i See Operating Instructions	
2	Unscrew bolts (2)		
3	Pull 110 V outside socket (1) out of side wall	i Until rear housing (6) of 110 V outside socket (1) is accessible.	

4	Remove foam pad (3)		
5	Remove bolts (4).		
6	Remove clamping bracket (5)		
7	Push back rear housing (6)		
8	Mark installation position of electrical lines (8)		
9	Loosen bolts (7)		
10	Remove electrical lines (8) from 110 V outside socket (1)		
11	Remove rear housing (6)		
12	Install in the reverse order		
13	Perform a function test	<p>i Connect external 110 V feed line to vehicle. Plug symbol should be visible on central electronics display (see owner's manual).</p>	

MODEL 903.662

with CODE (ZU8) National version for USA

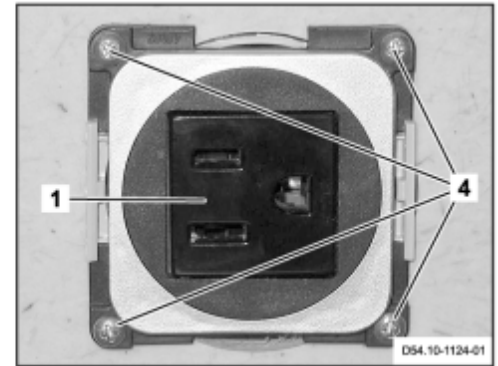
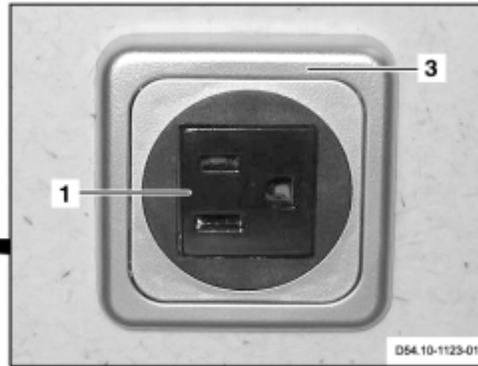
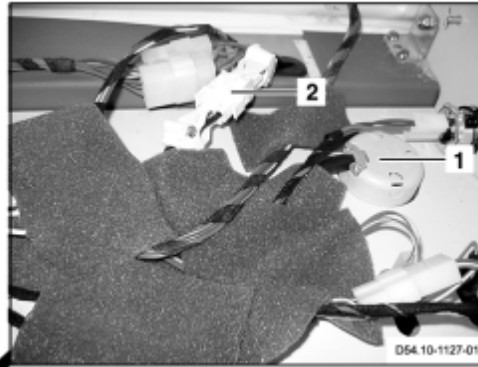
with CODE (Z29) "James Cook" touring camper, NAFTA
in longitudinal wall cupboard



D54.10-1128-09

1 110 V internal socket
2 Electrical connector

3 Covering

4 Bolts

☒ ☒	Remove/Install		
⚠ Danger!	Risk of death from coming into contact with electrical parts of the 110 V system Risk of injury from burns which may be caused by electric shock or by current flowing directly through parts of the body.	Do not touch voltage conducting parts in the 110 V system.	AS00.00-Z-0027-01A
1	Disconnect external 110 V feed line from vehicle	i See Operating Instructions	
2	Remove right floor in cupboard	In longitudinal wall cupboard	AR86.60-D-0050-01A
3	Remove foam pads from lines around 110 V internal socket (1)		

4	Disconnect electrical connector (2)		
5	Release covering (3)	 Mounting wedge	110 589 03 59 00
6	Remove bolts (4).		
7	Remove 110 V internal socket (1)		
8	Install in the reverse order		
9	Perform a function test	 Connect external 110 V feed line to vehicle and electrical consumers to 110 V internal socket (1) and check that they function correctly.	



110 589 03 59 00

Mounting wedge

MODEL 903.662

with CODE (ZU8) National version for USA

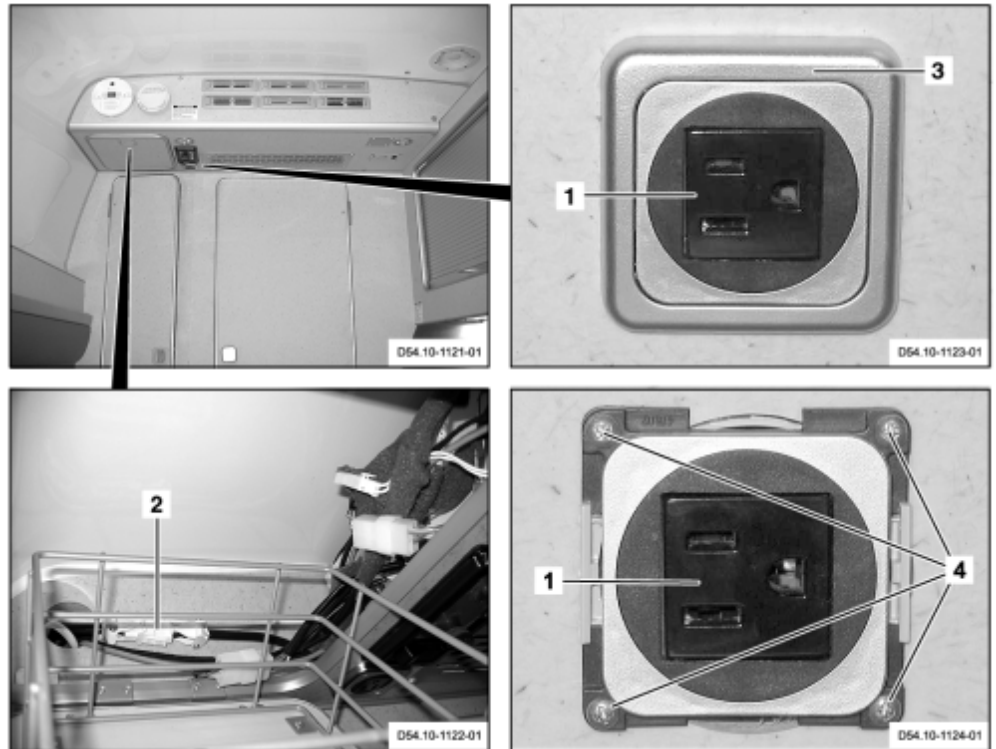

with CODE (Z29) "James Cook" touring camper, NAFTA
on transverse wall cupboard

- 1 110 V internal socket
- 2 Electrical connector
- 3 Covering
- 4 Bolts



D54.10-1125-06

☒ ☒	Remove/Install		
⚠ Danger!	Risk of death from coming into contact with electrical parts of the 110 V system Risk of injury from burns which may be caused by electric shock or by current flowing directly through parts of the body.	Do not touch voltage conducting parts in the 110 V system.	AS00.00-Z-0027-01A
1	Disconnect external 110 V feed line from vehicle	i See Operating Instructions	
2	Remove wall cupboard cover panel	On right at side	AR86.60-D-0051-01A
3	Remove wall cupboard cover panel	On right at rear	AR86.60-D-0051-01B
4	Disconnect electrical connector (2)		

5	Remove cable ties from lines around 110 V internal socket (1)		
6	Release covering (3)	 Mounting wedge	110 589 03 59 00
7	Remove bolts (4).		
8	Remove 110 V internal socket (1)		
9	Install in the reverse order		
10	Perform a function test	 Connect external 110 V feed line to vehicle and electrical consumers to 110 V internal socket (1) and check that they function correctly.	



110 589 03 59 00

Mounting wedge

MODEL 903.662

with CODE (ZU8) National version for USA

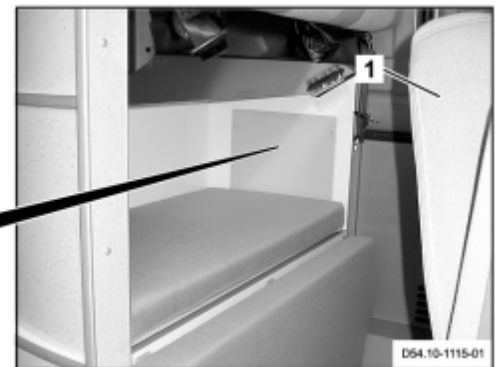
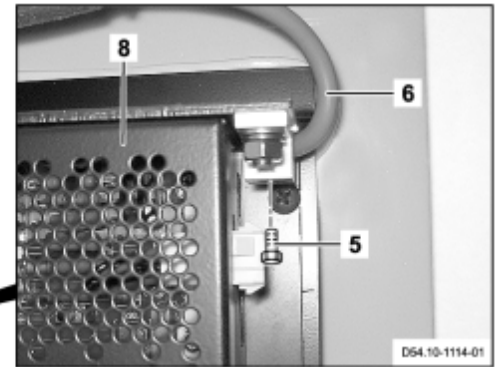
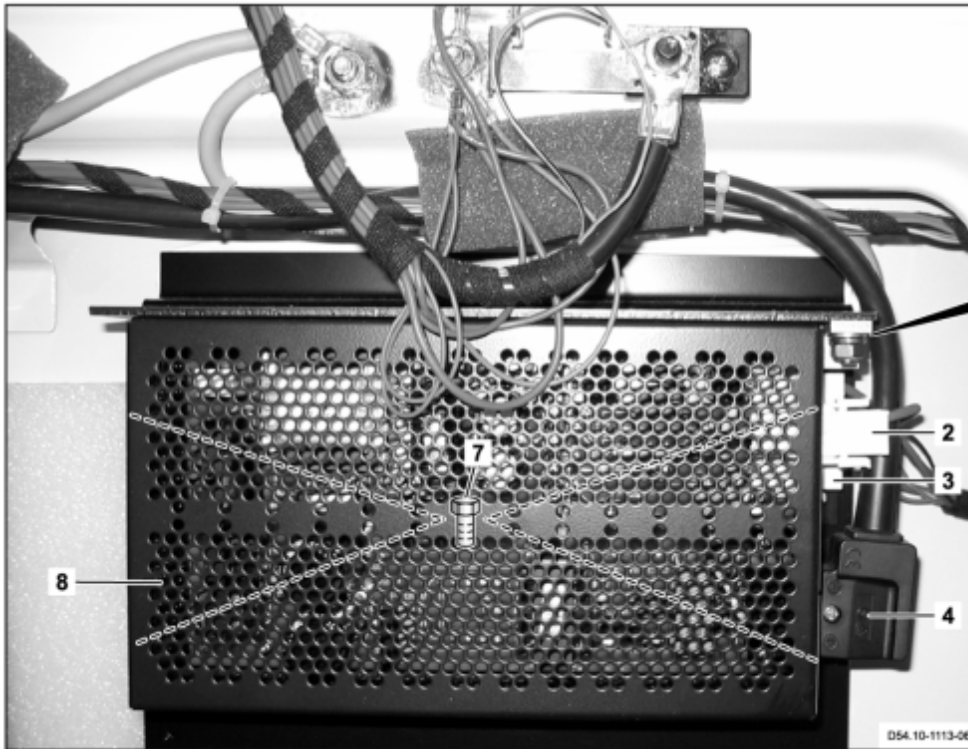
with CODE (Z29) "James Cook" touring camper, NAFTA
110-V system for additional batteries

D54.10-1116-09

1 Bench seat

2 Electrical connector

3 Electrical connector



4 Electrical connector

5 Screw

6 Ground line

7 Bolts

8 Battery charger

	Remove/Install		
1	Separate external 110-V feed line from vehicle	 See Operating Instructions	
2	Position bench seat (1) forward	 See Operating Instructions	
3	Remove panel at front of kitchen block	Paneling in front of battery charger.	AR68.30-D-4630-01A
4	Detach electrical couplings (2, 3, 4) from battery charger (8)		
5	Loosen screw (5)		
6	Remove ground line (6) from battery charger (8)		

7	Unscrew bolts (7).		
8	Remove battery charger (8)		
9	Install in the reverse order		
10	Perform function check	i With an external 110-V connection the symbol for the mains voltage of the charger must appear on the display of the central electronics (see operator's manual).	

MODEL 903.662

with CODE (ZU8) National version for USA

with CODE (Z29) "James Cook" touring camper, NAFTA

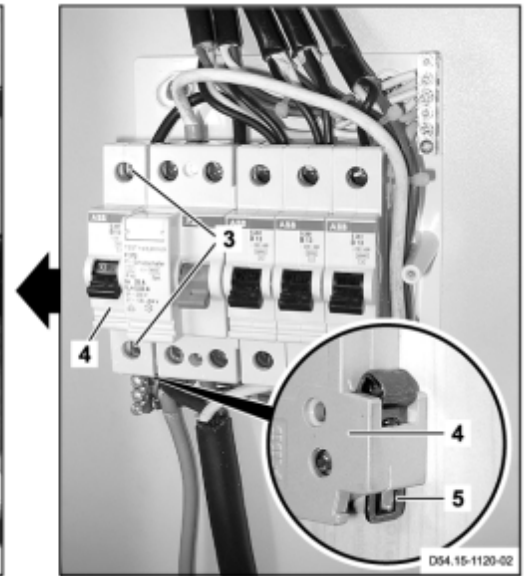
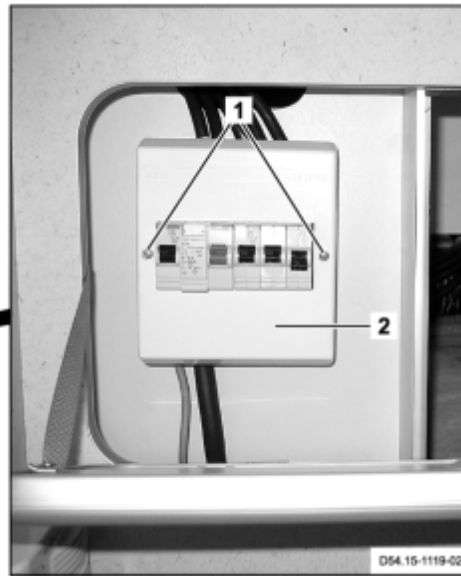



D54.15-1121-08

1 Bolts
2 Cover

3 Bolts
4 Circuit breaker

5 Bow

	Remove/Install		
 Danger!	Risk of death from coming into contact with electrical parts of the 110 V system Risk of injury caused by burns, which can be produced by electrical shocks or by body parts coming in direct contact with electrical currents.	Do not touch any conductive parts of the 110 V system.	AS00.00-Z-0027-01A
1	Separate external 110-V feed line from the vehicle	 See Operator's Manual	
2	Remove bolts (1)		
3	Take off cover (2)		
4	Loosen screws (3) of circuit breaker (4) to be removed		
5	Pull leads out of the circuit breaker (4) to be removed		
6	Unlock the circuit breaker (4) at the bottom of the bracket (5)		

7	Take out the circuit breaker (4) forwards		
8	Install in the reverse order		
9	Perform function check	i With an external 110-V connection, the symbol for charger mains voltage must appear on the central electronics display (see operator's manual).	

MODEL 903.662

with CODE (ZU8) National version for USA

with CODE (Z29) "James Cook" touring camper, NAFTA
of the roof air conditioning control unit

- 1 Cover
- 2 Roof air conditioning control
- 3 Fuse carrier
- 4 Caps
- 5 Fuses

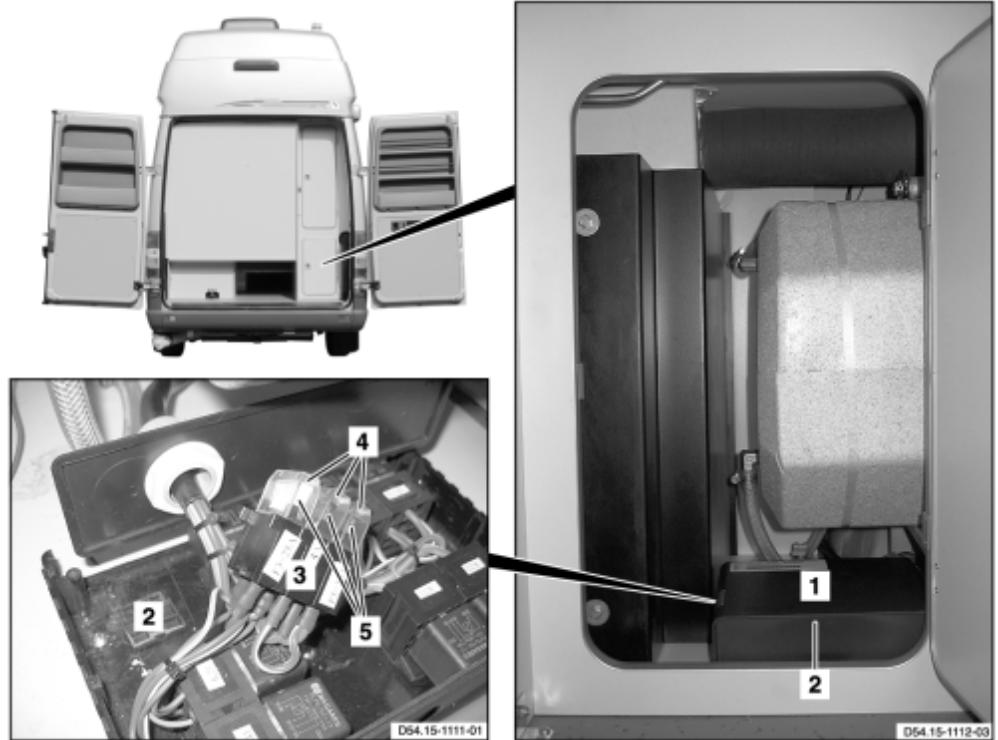

D54.15-1113-06

☒ ☒	Remove/Install		
1	Switch off roof air conditioning	i See Operating Instructions	
2	Remove cover (1) of air conditioning system control (2)	i Unclip cover (1) on both sides.	
3	Unclip fuse carrier (3) on the roof air conditioning control (2)	i Unclip fuse carrier (3) on both sides.	
4	Detach cap (4) of the fuse to be removed (5) from fuse carrier (3)		
5	Pull fuse to be removed (5) out of the fuse carrier (3)		
6	Install in the reverse order		

MODEL 903.662

with CODE (ZU8) National version for USA

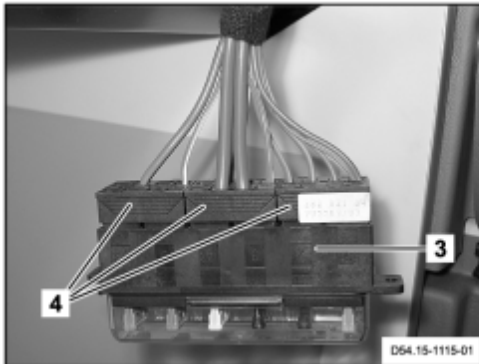
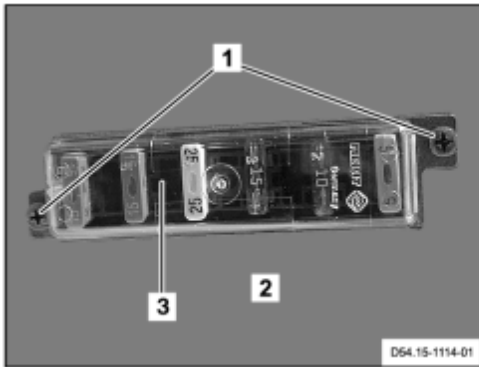
with CODE (Z29) "James Cook" touring camper, NAFTA
on seat belt support

D54.15-1117-09

1 Bolts
2 Belt support

3 Fuse box

4 Electrical connectors

☒ ☒	Remove/Install		
⚠ Danger!	Risk of injury caused by body parts becoming jammed, pinched or severed by doors, covers, flaps or by loose components	Keep body parts well clear when moving doors, covers, flaps and components. Wear protective gloves and protective shoes.	AS00.00-Z-0025-01A
1	Move bench seat forward	i See Operator's Manual	
2	Remove bolts (1)		
3	Pull fuse box (3) out of seat belt support (2)		
4	Disconnect electrical couplings (4) from the fuse box (3)		
5	Install in the reverse order		

6

Perform function check

i of all electrical components which are fused via the fuse box (3) (see operator's manual).

MODEL 903.662

with CODE (ZU8) National version for USA

with CODE (Z29) "James Cook" touring camper, NAFTA

The roof air conditioning on the switched-mode power supply

1 Cover of switched-mode power supply



D54.15-1105-06

3 Cover

4 Electrical wiring

5 Web-type fuse of switched-mode power supply

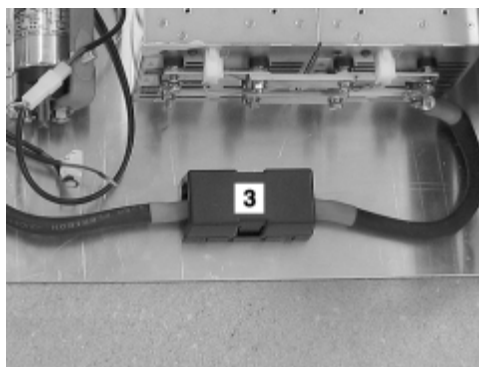

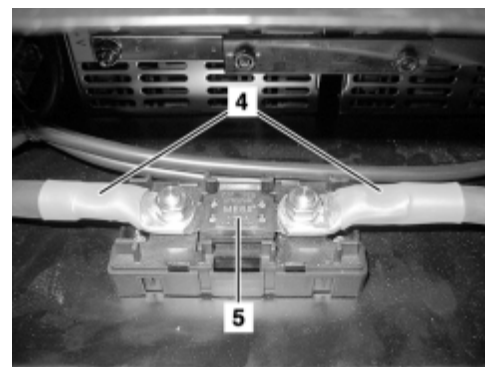

D54.15-1106-01



D54.15-1107-01

	Remove/Install		
Danger!	Risk of death from coming into contact with electrical parts of the 110 V system Risk of injury caused by burns, which can be produced by electrical shocks or by body parts coming in direct	Do not touch any conductive parts of the 110 V system.	AS00.00-Z-0027-01A

	contact with electrical currents.		
1	Switch off roof air conditioning	 See Operator's Manual	
2	Separate external 110-V feed line from the vehicle	 See Operator's Manual	
3	Remove web-type fuse	of the roof air conditioning in the engine compartment	AR54.15-D-2100B
4	Remove cover of switched-mode power supply (1)		AR54.21-D-0030-01A
5	Remove cover (3) from fuse box		
6	Unscrew nuts of electrical lines (4)		
7	Lift up electrical lines (4) slightly	 Avoid short circuit due to ground contact of electrical lines (4) and as a result destruction of electrical components.	
8	Remove web-type fuse of switched-mode power supply (5)		
9	Install in the reverse order		

MODEL 903.662

with CODE (ZU8) National version for USA

with CODE (Z29) "James Cook" touring camper, NAFTA
of the roof air conditioning in the engine compartment

- 1 Cover
- 2 Electrical wiring
- 3 Web-type fuse

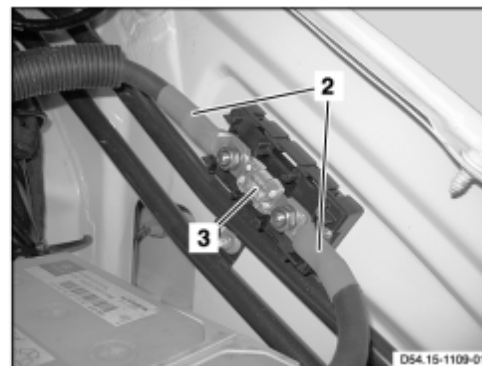

D54.15-1110-06

☒ ☒	Remove/Install		
⚠ Danger!	Risk of death from coming into contact with electrical parts of the 110 V system Risk of injury caused by burns, which can be produced by electrical shocks or by body parts coming in direct contact with electrical currents.	Do not touch any conductive parts of the 110 V system.	AS00.00-Z-0027-01A
1	Switch off roof air conditioning	i See Operator's Manual	
2	Separate external 110-V feed line from the vehicle	i See Operator's Manual	
3	Open engine hood		
4	Remove cover (1) from the fuse box		
5	Unscrew nuts of electrical lines		

	(2)		
6	Lift up electrical lines (2) slightly	 Avoid short circuit due to ground contact of electrical lines (2) and as a result the destruction of electrical components.	
7	Remove web-type fuse (3)		
8	Install in the reverse order		

MODEL 903.662

with CODE (ZU8) National version for USA

with CODE (Z29) "James Cook" touring camper, NAFTA

1 Trim panel

2 Central electronics

3 Access covers





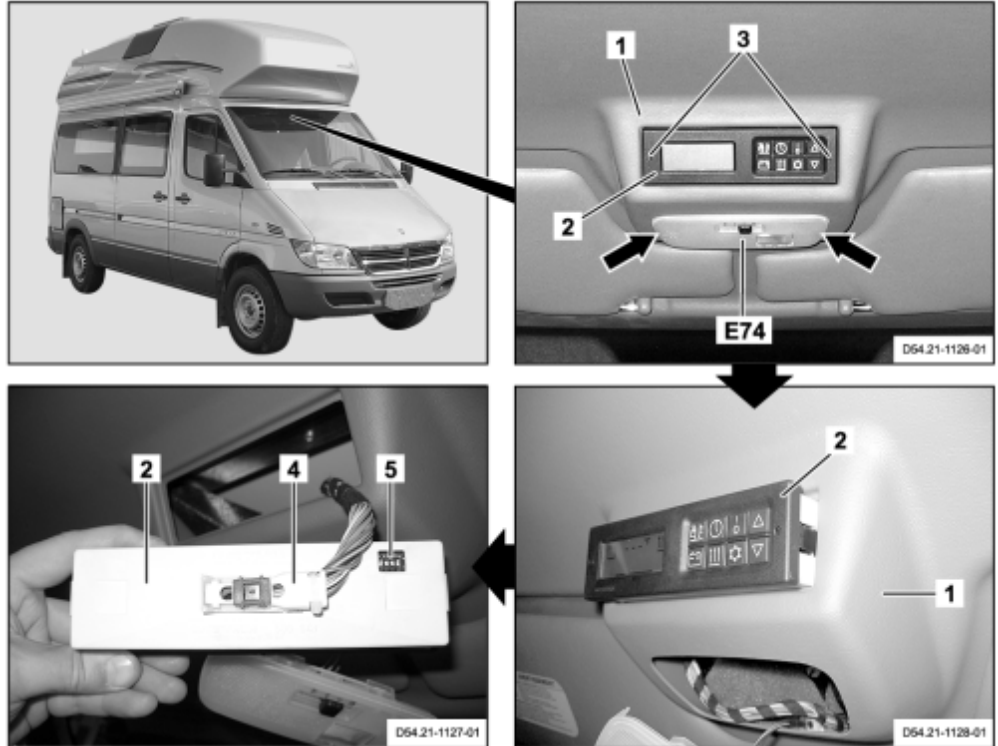

4 Electrical connector

5 Switches

E74 Front center interior lamp



D54.21-1129-06

 	Remove/Install		
1	Note adjustments of central electronics (2)	 Inquiry concerning customer-specific adjustments (see operator's manual).	
2	Remove front center interior lamp (E74)	 Unclip front center interior lamp (E74) from paneling (1) on both sides (arrows).	
		 Mounting wedge	110 589 03 59 00
3	Unlock central electronics (2) on both sides	 Insert suitable drift in the side assembly openings (3).	
4	Remove central electronics (2)	 Press the central electronics (2) out of the paneling (1) through the opening in the front center interior lamp (E74).	
5	Unlock the electrical coupling (4)		

6	Detach electrical coupling (4) from the central electronics (2)	i Installation: When installing new central electronics (2) the switches (5) on the back should be adjusted as per the old part.	
7	Install in the reverse order		
8	Program the central electronics (2)	i Check customer-specific adjustments on the central electronics (2) and adjust if necessary.	
9	Carry out self-test for central electronics (2)		AR54.21-D-0021A



110 589 03 59 00

Mounting wedge

MODEL 903.662

with CODE (ZU8) National version for USA

with CODE (Z29) "James Cook" touring camper, NAFTA

- 1 Switches
- 2 Switches
- 3 Switches
- 4 Switches
- 5 Central electronics

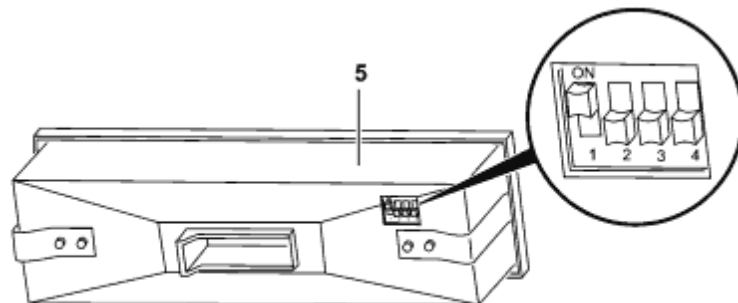

D54.21-1124-10

- 5 Central electronics
- 6 Fresh water level display
- 7 Symbol for battery mode
- 8 Multiple display
- 9 Symbol for mains voltage, charger
- 10 Symbol for stationary heater mode
- 11 Symbol for wastewater level indicator
- 12 Symbol for timer
- 13 Symbol for cut-in times for stationary heater
- 14 Capacity display for additional batteries
- 15 Symbol for refrigerator box, refrigerator
- 16 Outside temperature button
- 17 Timer button
- 18 ON-OFF button
- 19 Up button
- 20 Battery voltage button
- 21 Heater button
- 22 Refrigerator box button, refrigerator button
- 23 Down button

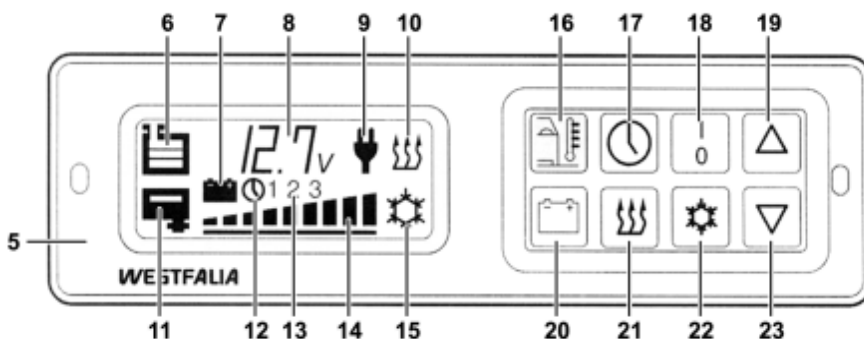

D54.21-1125-04

	Procedure		
1	Start the self-test by	i	The auxiliary heater must be

	simultaneously pressing the outside temperature button (16), ON-OFF button (18), battery voltage button (20) and DOWN button (23)	switched off and the after-run finished.	
		i Keep the outside temperature button (16), ON-OFF button (18), battery voltage button (20) and DOWN button (23) for approx. 7 seconds, then start with the self-tests within 60 seconds.	
		i The self-test mode is started when all the symbols appear on the display of the central electronics (5).	
2	Carry out self-test for switch position 1 or 2 batteries	i Switch (1) on the back of the central electronics (5).	AR54.21-D-0021-01A
3	Carry out self-test for switch position battery model 1 or 2	i Switch (2) on the back of the central electronics (5).	AR54.21-D-0021-02A
4	Carry out self-test for switch position of refrigerator box or refrigerator	i Switch (3) on the back of the central electronics (5).	AR54.21-D-0021-03A
5	Carry out self-test for switch position degrees Celsius or degrees Fahrenheit	i Switch (4) on the back of the central electronics (5).	AR54.21-D-0021-04A
6	Carry out self-test for fresh water sensor		AR54.21-D-0021-05A
7	Carry out self-test for wastewater sensor		AR54.21-D-0021-06A
8	Carry out self-test for refrigerator temperature and refrigerator box temperature		AR54.21-D-0021-07A
9	Carry out self-test for heater temperature		AR54.21-D-0021-08A
10	Carry out self-test for battery current		AR54.21-D-0021-09A
11	Carry out self-test for refrigerator and refrigerator box		AR54.21-D-0021-10A
12	Carry out self-test for heater		AR54.21-D-0021-11A
13	Carry out self-test for outside temperature button (16)		AR54.21-D-0021-12A

14	Carry out self-test for battery voltage button (20)		AR54.21-D-0021-13A
15	Carry out self-test for timer button (17)		AR54.21-D-0021-14A
16	Carry out self-test for heater button (21)		AR54.21-D-0021-15A
17	Carry out self-test for ON-OFF button (18)		AR54.21-D-0021-16A
18	Carry out self-test for refrigerator box button and refrigerator button (22)		AR54.21-D-0021-17A
19	Carry out self-test for UP button (19)		AR54.21-D-0021-18A
20	Finish self-test by pressing the DOWN button (23)	 The operating mode stored before the start of test is resumed.	

AR54.21-D-0030A

Remove/install switched-mode power supply for roof air conditioning

22.4.04

MODEL 903.662

with CODE (ZU8) National version for USA

with CODE (Z29) "James Cook" touring camper, NAFTA

1 Cover
2 Bleeding

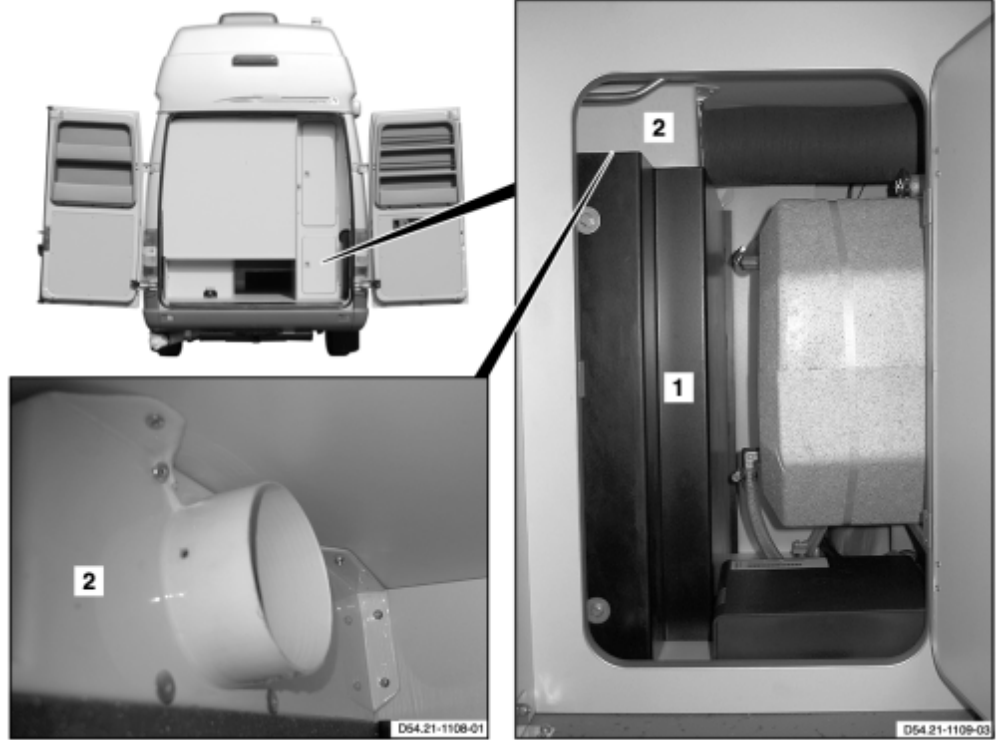

D54.21-1110-06

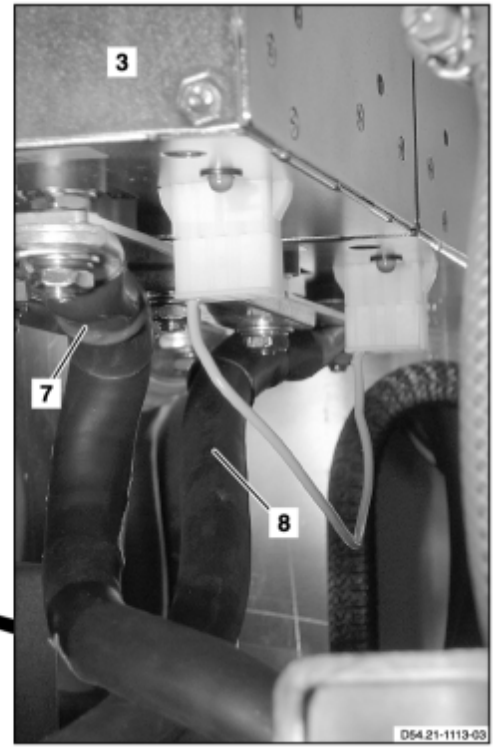
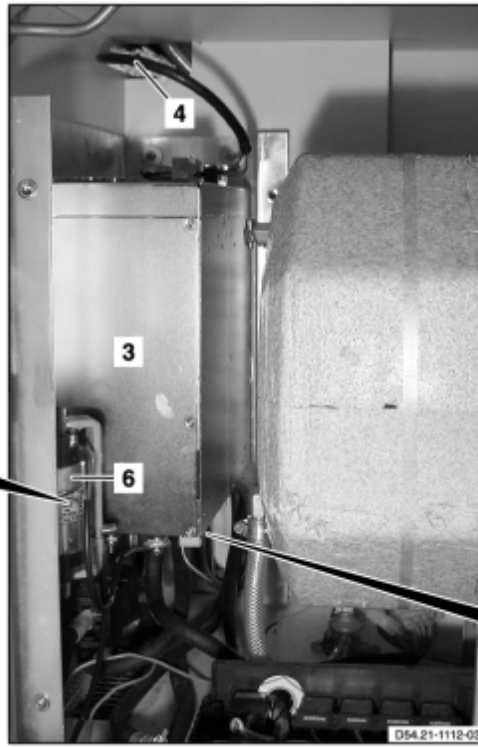

D54.21-1114-09

3 Switched-mode power supply
4 Electrical connector
6 Load relay

7 Electrical wiring
8 Electrical line

9 Electrical line
10 Electrical line

3 Switched-mode power supply
5 Hose clamps
11 Bolts
12 Nut



D54.21-1118-06

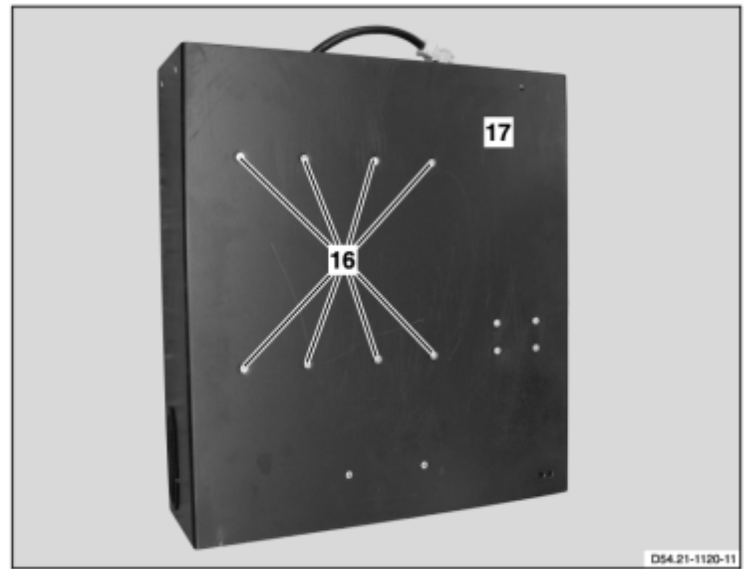
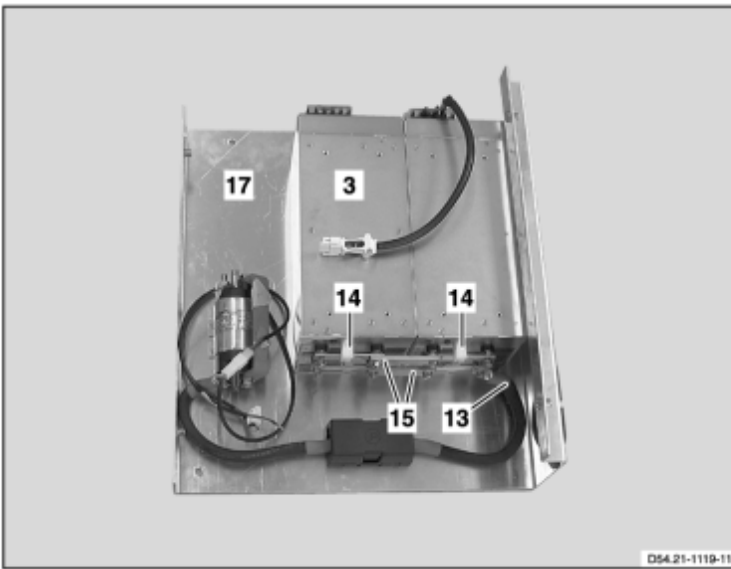





D54.21-1121-08

3 Switched-mode power supply
13 Electrical line

14 Electrical connector
15 Line bridges

16 Bolts
17 Carrier plate

	Remove/Install		
Danger!	Risk of death from coming into contact with electrical parts of the 110 V system Risk of injury caused by burns, which can be produced by electrical shocks or by body parts coming in direct contact with electrical currents.	Do not touch any conductive parts of the 110 V system.	AS00.00-Z-0027-01A
	Evaluating electronic components after repair and painting work and after accidents	All models	AH54.00-P-1000-01A
1	Switch off roof air conditioning	See Operator's Manual	
2	Separate external 110-V feed line from the vehicle	See Operator's Manual	
3	Remove web-type fuse	of the roof air conditioning in the engine compartment	AR54.15-D-2100B
4	Remove cover (1)		AR54.21-D-0030-01A
5	Remove venting of switched-mode power supply (2)		AR54.21-D-0031A
6	Mark installation position of electrical lines (7, 8, 9, 10, 13)	Mixing up the electrical lines (7, 8, 9, 10, 13) can result in short circuit and therefore result in the destruction of electrical components.	

7	Disconnect electrical connector (4)		
8	Unscrew nut of electrical line (9) at the top from the load relay (6)		
9	Remove electrical line (9) from load relay (6)		
10	Unscrew nut of electrical line (10) from load relay (6)		
11	Remove electrical line (10) from load relay (6)		
12	Unscrew nut of electrical line (7) from switched-mode power supply (3)		
13	Remove electrical line (7) from switched-mode power supply (3)		
14	Unscrew nut of electrical line (8) from switched-mode power supply (3)		
15	Remove electrical line (8) from switched-mode power supply (3)		
16	Unscrew bolts (11).		
17	Unscrew nut (12)	 Installation: Replace self-locking nut (12).	
	Notes on self-locking nuts and bolts	All models	AH00.00-N-0001-01A
 Danger!	Risk of injury caused by hot water exiting from the lines of the fresh water system	Shut off the water heater in a timely manner before starting repair work. Let the water in the lines and in the components of the fresh water system cool down to room temperature.	AS86.00-Z-0002-01A
18	Carrier plate (17) with switched-mode power supply (3)	 Do not loosen or detach hose clamps (5).	
		 If there is a shortage of space the hose clamps (5) on the hot-water heater are to be twisted.	
19	Unscrew nut of electrical line (13) from switched-mode power supply (3)		
20	Remove electrical line (13) from switched-mode power supply (3)		
21	Separate electrical connector		

	(14) of switched-mode power supply (3)		
22	Unscrew nuts of line bridges (15) of switched-mode power supply (3)		
23	Unscrew bolts (16) on the back of the carrier plate (17)		
24	Remove switched-mode power supply (3) from the carrier plate (17)		
25	Install in the reverse order		
26	Perform a function test	i Switch on/switch off roof air conditioning (see operator's manual).	

MODEL 903.662

with CODE (ZU8) National version for USA

with CODE (Z29) "James Cook" touring camper, NAFTA

1 Cover of switched-mode power supply

2 Screw

3 Bleed hose

4 Bolts

5 Bleeding

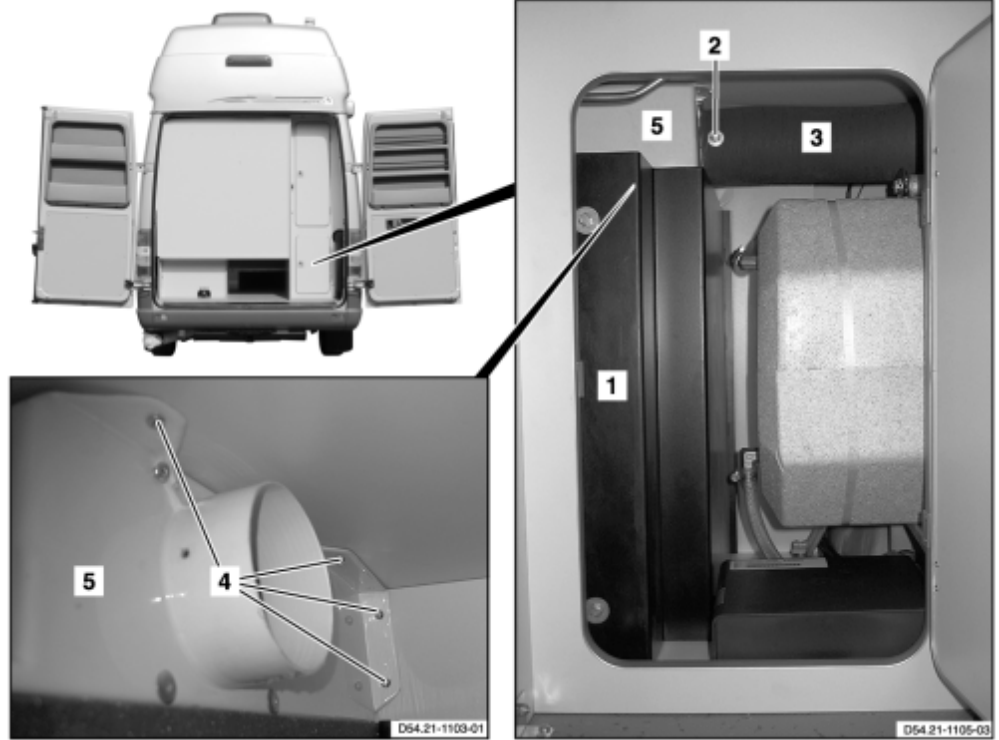

D54.21-1104-06

5 Bleeding



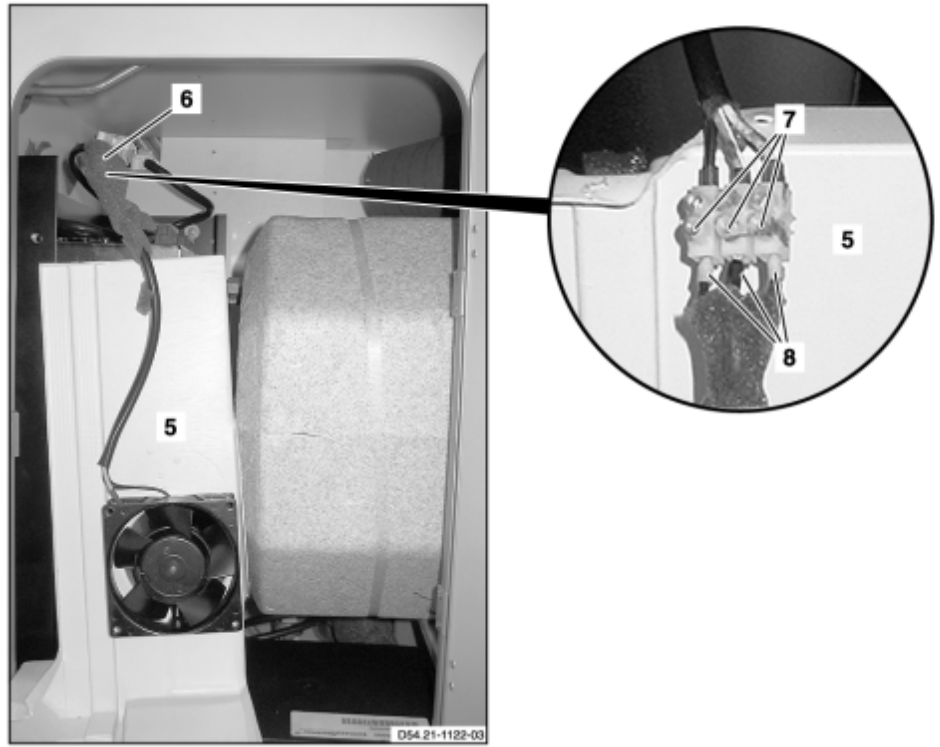

6 Foam insulation

7 Bolts

8 Electrical wiring



D54.21-1123-06

 	Remove/Install		
1	Remove cover of air conditioning switched-mode power supply (1)		AR54.21-D-0030-01A
2	Unscrew bolt (2).		
3	Detach bleed hose (3) from vent (5)		
4	Remove bolts (4).		
5	Remove vent (5) from switched-mode power supply		
6	Remove foam insulation (6)	 Installation: Replace foam insulation (6)	
7	Mark installation position of electrical lines (8)	 Mixing up electrical lines (8) can lead to short circuit and as a result to the destruction of electrical components.	
8	Loosen bolts (7) of lamp-wire connector		
9	Remove electrical lines (8) from lamp-wire connector		
10	Remove vent (5)		
11	Install in the reverse order		

MODEL 903.662

with CODE (ZU8) National version for USA

with CODE (Z29) "James Cook" touring camper, NAFTA

1 Fill level indicator



2 Bolts

3 Electrical connector

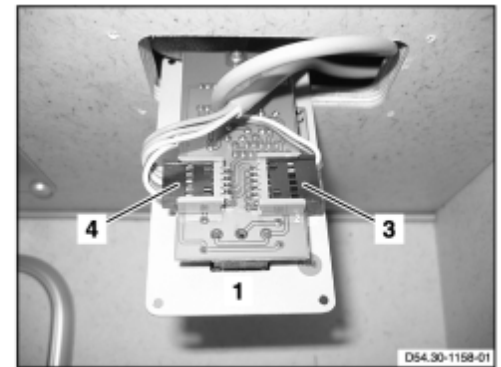
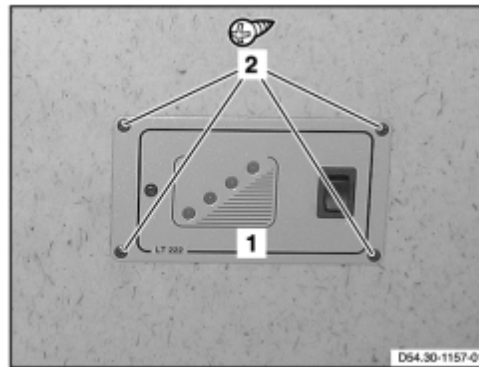
4 Electrical connector



D54.30-1159-06

 	Remove/Install		
1	Remove screws (2)		
2	Guide fill level indicator (1) transversely out of suspended housing		
3	Detach electrical coupling (3) from fill level indicator (1)		
4	Detach electrical coupling (4) from fill level indicator (1)		
5	Remove fill level indicator (1)		
6	Install in the reverse order		
7	Perform function check	 Switch on fill level indicator (1) (see operator's manual).	

MODEL 903.662

with CODE (ZU8) National version for USA

with CODE (Z29) "James Cook" touring camper, NAFTA

1 Smoke detector

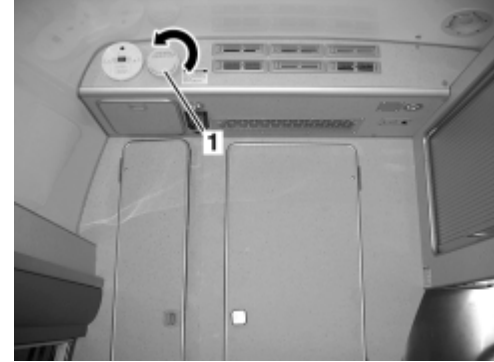

D54.65-1126-01

	Remove/Install		
1	Twist smoke detector (1) in direction of arrow		
2	Remove smoke detector (1)		
3	Install in the reverse order		

MODEL 903.662



with CODE (ZU8) National version for USA

with CODE (Z29) "James Cook" touring camper, NAFTA

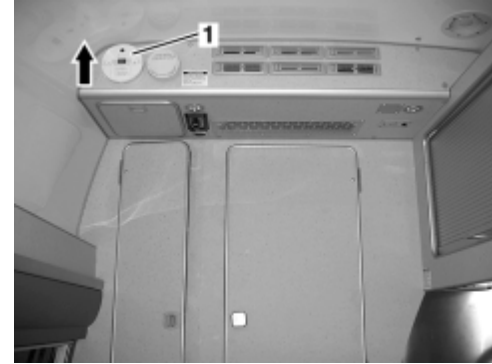
1 CO-detector



D54.65-1125-01

 	Remove/Install		
1	Move CO-detector (1) in direction of arrow		
2	Remove CO-detector (1)		
3	Install in the reverse order		

MODEL 903.662

with CODE (ZU8) National version for USA

with CODE (Z29) "James Cook" touring camper, NAFTA

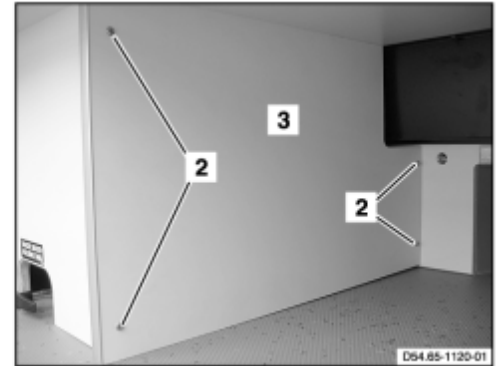
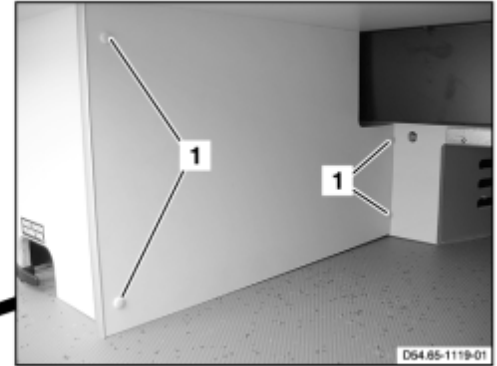

D54.65-1121-09

1 Caps

2 Bolts

3 Cover



D54.65-1124-08

4 Electrical connector

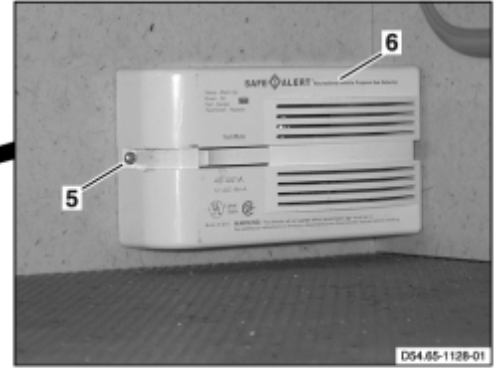
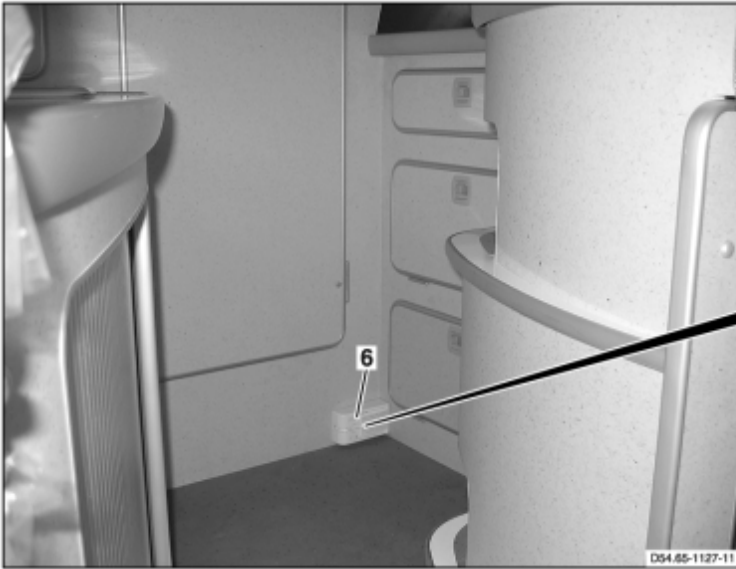

D54.65-1129-08

5 Screw

6 Gas detector

	Remove/Install		
1	Remove covering caps (1)		
2	Unscrew bolts (2)		
3	Take out cover (3)		
4	Disconnect electrical connector (4)		
5	Unscrew bolt (5).		
6	Take out gas detector (6)		
7	Install in the reverse order		

MODEL 903.662

with CODE (ZU8) National version for USA

with CODE (Z29) "James Cook" touring camper, NAFTA

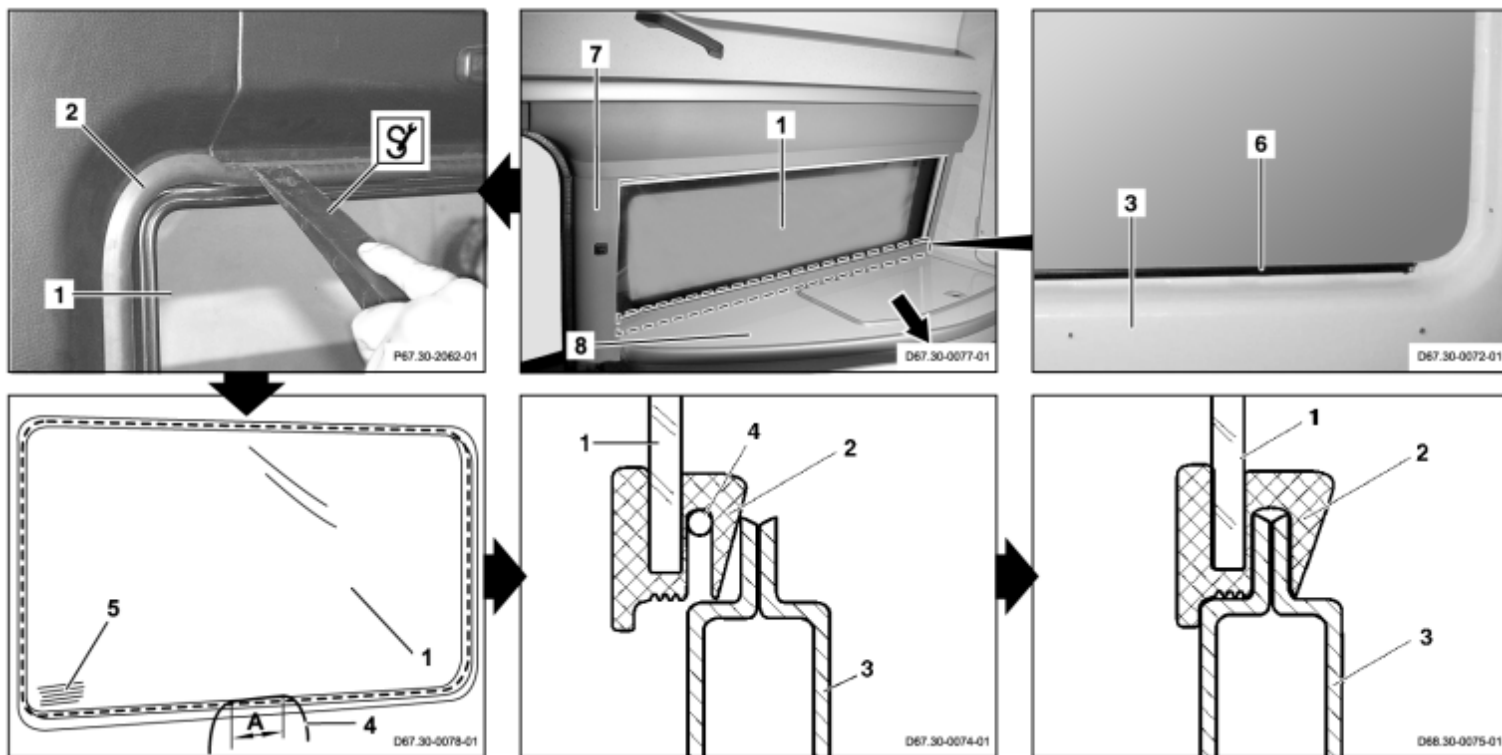











D67.30-0079-09

1 Door window
2 Sealing rubber
3 Body flange

4 Installation cord
5 Imprint
6 Spacer rail

7 Paneling
8 Stowage cabinet

	Remove		
Danger!	Risk of injury caused by scraping or cutting body parts on sharp vehicle parts	Always wear protective gloves when working on or near sharp and undeurred vehicle parts. Deburr replacement panels.	AS00.00-Z-0017-01B
Danger!	Injury hazard by pinching or cutting off extremities with doors, covers, flaps and loose components	Keep limbs away from motion area when moving doors, covers, flaps and components. Wear protective gloves	AS00.00-Z-0025-01A
Danger!	Risk of injury due to hands being crushed when window glass is not secure	Secure window to prevent it from falling down.	AS67.00-Z-0002-01A
1	Remove C-pillar paneling (7)	Right side	AR68.30-D-4490A

2	Loosen stowage cabinet (8)	Refrigerator box	AR86.60-D-0045A
3	Slightly pull stowage cabinet (8) of refrigerator box from side wall paneling to center of vehicle (arrow).	 Until sufficient accessibility to the sealing rubber (2) of the side window is ensured	
4	Remove wardrobe storage shelf		AR86.60-D-0061A
5	Install two cup suction tools on outside of side window (1)	 Cup suction tool	WH58.30-Z-1010-02A
6	Pry rubber lip on sealing rubber (2) over edge of body flange (3) of side wall paneling toward outside	 Helper holds side window (1) with cup suction tools.	
		 Cup suction tool	WH58.30-Z-1010-02A
		 Mounting wedge	110 589 03 59 00
7	Remove side window (1) with cup suction tools		
8	Pull sealing rubber (2) off of side window (1)	 Check whether sealing rubber (2) and side window (1) can be reused	
	Install		
9	Check spacer rail (6) for correct seat		
10	Pull sealing rubber (2) over edge of side window (1)	 The long chamfered lip of the sealing rubber (2) should point toward the passenger compartment. The imprint (5) should be positioned at the bottom of the side window after inserting.	
11	Lay installation cord (4) below long lip of sealing rubber (2) around entire side window (1)	 Allow installation cord (4) to overlap 10 cm (A) at bottom of side window	
12	Coat chamfered side of sealing rubber (2) with lubricant	Lubricant	BR00.45-Z-1039-06A
13	Press side window (1) to body flange (3) of side wall paneling	 Uniformly press side window (1) with sealing rubber (2) attached against body flange (3) on side wall paneling from outside.	

		i Allow free ends of installation cord (4) to hang into passenger compartment.	
14	Uniformly pull free ends of pull-in cord (4) into passenger compartment.	i The long lip on the sealing rubber (2) should be positioned above the body flange (3) on the side wall paneling all the way around.	
15	Check whether sealing rubber (2) is seated correctly.	i Check whether sealing rubber (2) is seated correctly inside and outside; correct if necessary	
16	Check whether side window (1) is seated correctly.	i Check whether side window (1) is seated correctly inside and outside, correct if necessary	
17	Remove lubricant residues from side window (1) and sealing rubber (2)		
18	Remove both cup suction tools from outside of side window (1)	 Cup suction tool	WH58.30-Z-1010-02A
19	Install wardrobe storage shelf		AR86.60-D-0061A
20	Slide stowage cabinet (8) for refrigerator box back from center of vehicle to side wall paneling		
21	Fasten stowage cabinet (8)	Refrigerator box	AR86.60-D-0045A
22	Install C-pillar paneling (7)	Right side	AR68.30-D-4490A
23	Check side window (1) for leakage	i Perform water check.	
24	Clean side window (1)		



110 589 03 59 00

Mounting wedge

Commercially available tools (see Workshop Equipment Manual)

Number	Designation	Make (e. g.)	Order number
WH58.30-Z-1010-02A	Cup suction tool	Karl Assfalg KG Buchstr. 149 D-73525 Schwäbisch-Gmünd	602-2

Auxiliary repair materials

Number	Designation	Order number
BR00.45-Z-1039-06A	Lubricant	000 989 11 60

MODEL 903.662

with CODE (ZU8) National version for USA

with CODE (Z29) "James Cook" touring camper, NAFTA

On right sliding door

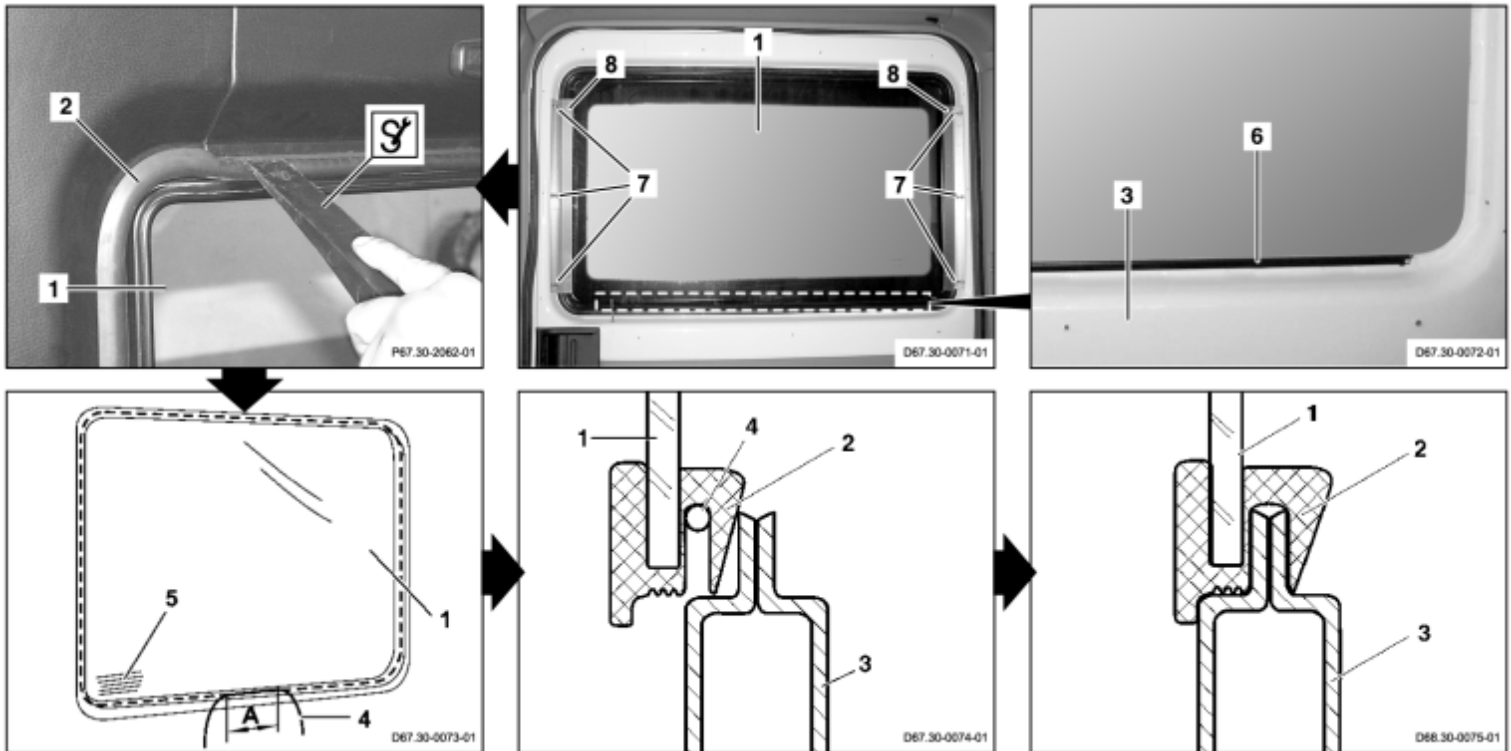











D67.30-0076-09







1 Door window
2 Sealing rubber
3 Body flange

4 Installation cord
5 Imprint
6 Spacer rail

7 Bolts
8 Mounting angle

	<p>Remove</p>		
<p>⚠ Danger!</p>	<p>Risk of injury caused by scraping or cutting body parts on sharp vehicle parts</p>	<p>Always wear protective gloves when working on or near sharp and undeurred vehicle parts. Deburr replacement panels.</p>	<p>AS00.00-Z-0017-01B</p>
<p>⚠ Danger!</p>	<p>Injury hazard by pinching or cutting off extremities with doors, covers, flaps and loose components</p>	<p>Keep limbs away from motion area when moving doors, covers, flaps and components. Wear protective gloves</p>	<p>AS00.00-Z-0025-01A</p>
<p>⚠ Danger!</p>	<p>Risk of injury due to hands being crushed when window glass is not secure</p>	<p>Secure window to prevent it from falling down.</p>	<p>AS67.00-Z-0002-01A</p>
<p>1</p>	<p>Remove door paneling from</p>	<p>Upper door paneling</p>	<p>AR72.16-D-</p>

	sliding door		6610A
2	Remove roller sun blind		AR68.50-D-3400C
3	Unscrew bolts (7).		
4	Remove mounting angle (8)		
5	Install cup suction tool (1) on inside of side window	 Cup suction tool	WH58.30-Z-1010-02A
6	Pry rubber lip on sealing rubber (2) over edge of body flange (3) of sliding door toward outside	 Hold side window (1) with cup suction tool.	
		 Cup suction tool	WH58.30-Z-1010-02A
		 Mounting wedge	110 589 03 59 00
7	Remove side window (1) with cup suction tool	 Cup suction tool	WH58.30-Z-1010-02A
8	Pull sealing rubber (2) off of side window (1)	 Check whether sealing rubber (2) and side window (1) can be reused	
	Install		
9	Check spacer rail (6) for correct seat		
10	Pull sealing rubber (2) over edge of side window (1)	 The long chamfered lip of the sealing rubber (2) should point toward the passenger compartment. The imprint (5) should be positioned at the bottom edge of the side window after inserting.	
11	Lay installation cord (4) below long lip of sealing rubber (2) around entire side window (1)	 Allow installation cord (4) to overlap 10 cm (A) at bottom of side window	
12	Coat angled side of sealing rubber (2) with lubricant	Lubricant	BR00.45-Z-1039-06A
13	Press side window (1) to body flange (3) of sliding door	 Uniformly press side window (1) with sealing rubber (2) attached against body flange (3) on side wall paneling from outside.	
		 Allow free ends of installation cord (4) to hang into passenger compartment.	

14	Uniformly pull free ends of pull-in cord (4) into passenger compartment.	 The long lip of the sealing rubber (2) should be positioned above the body flange (3) on the side wall paneling all the way around.	
15	Check whether sealing rubber (2) is seated correctly.	 Check whether sealing rubber (2) is seated correctly inside and outside, correct if necessary	
16	Check whether side window (1) is seated correctly.	 Check whether side window (1) is seated correctly inside and outside, correct if necessary	
17	Remove cup suction tool on inside of side window (1)	 Cup suction tool	WH58.30-Z-1010-02A
18	Remove lubricant residues from side window (1) and sealing rubber (2)		
19	Install mounting bracket (8)	 For this purpose, screw in bolts (7).	
20	Install roller sun blind		AR68.50-D-3400C
21	Install door panel for sliding door	Upper door panel	AR72.16-D-6610A
22	Check side window (1) for leakage	 Perform water check.	
23	Clean side window (1)		



110 589 03 59 00

Mounting wedge

Commercially available tools (see Workshop Equipment Manual)

Number	Designation	Make (e. g.)	Order number
WH58.30-Z-1010-02A	Cup suction tool	Karl Assfalg KG Buchstr. 149 D-73525 Schwäbisch-Gmünd	602-2

Auxiliary repair materials

Number	Designation	Order number
BR00.45-Z-1039-06A	Lubricant	000 989 11 60

MODEL 903.662

with CODE (ZU8) National version for USA

with CODE (Z29) "James Cook" touring camper, NAFTA

High roof side vent window

1 Vent windows

2 Screw

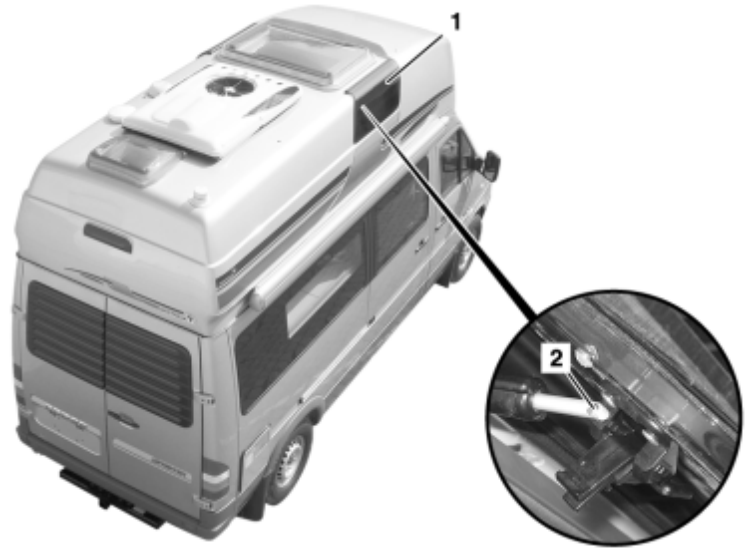

D67.30-0067-11

☒ ☒	Remove/Install		
⚠ Danger!	Risk of death caused by falling from vehicle roof. Risk of injury to other persons caused by falling objects during work in roof area.	Perform work on and in area of vehicle roof only with suitable aids (ladders, scaffolding, assembly platforms). Sufficiently secure working area	AS65.00-Z-0002-01B
1	Open vent window (1)		
2	Unscrew bolt (2) from outside		
3	Completely open vent window (1)		
4	Unhook vent window (1) from rail downward		
5	Install in the reverse order		

MODEL 903.662

with CODE (ZU8) National version for USA

with CODE (Z29) "James Cook" touring camper, NAFTA

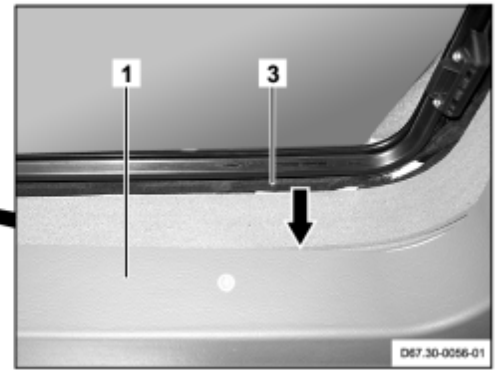
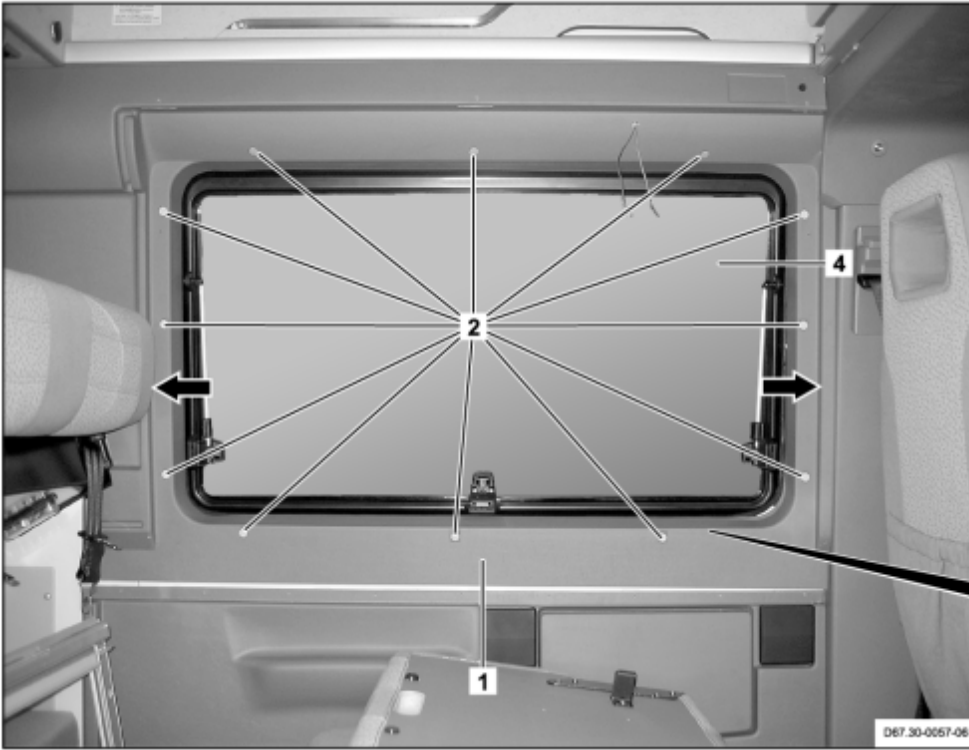









D67.30-0058-09

1 Paneling
2 Bolts

3 Felt strip
4 Vent windows



D67.30-0061-08

	Remove		
1	Remove roller sun blind	On left center vent window	AR68.50-D-3400A
2	Press paneling (1) in direction of arrow	 Carefully press paneling (1) in direction of arrow to prevent damaging the paneling (1)  Until caps are accessible	
3	Remove caps from bolts (2)		
4	Remove felt strips (3)		
5	Unscrew bolts (2)		
6	Remove vent window (4)		
	Install		
	Clean sealing surfaces on vent window (4) and vehicle, remove sealant residues if necessary		BR00.45-Z-1014-04A
7	Apply sealant to sealing surfaces on vent window (4)	 Use suitable sealant	
8	Install vent window (4)		
9	Screw in bolts (2)		
10	Install felt strips (3)	 Carefully press paneling (1) in direction of arrow to prevent damaging the paneling (1)	
11	Install caps on bolts (2)	 Carefully press paneling (1) in direction of arrow to prevent damaging the paneling (1)	
		 Until caps are accessible	
12	Install left center vent window sun shade		AR68.50-D-3400A
13	Check vent window (4) for leakage		

Auxiliary repair materials

Number	Designation	Order number
BR00.45-Z-1014-04A	Adhesion cleaner	003 989 72 71

MODEL 903.662

with CODE (ZU8) National version for USA

with CODE (Z29) "James Cook" touring camper, NAFTA

Side high roof vent window

1 Vent windows

2 Sealing frame

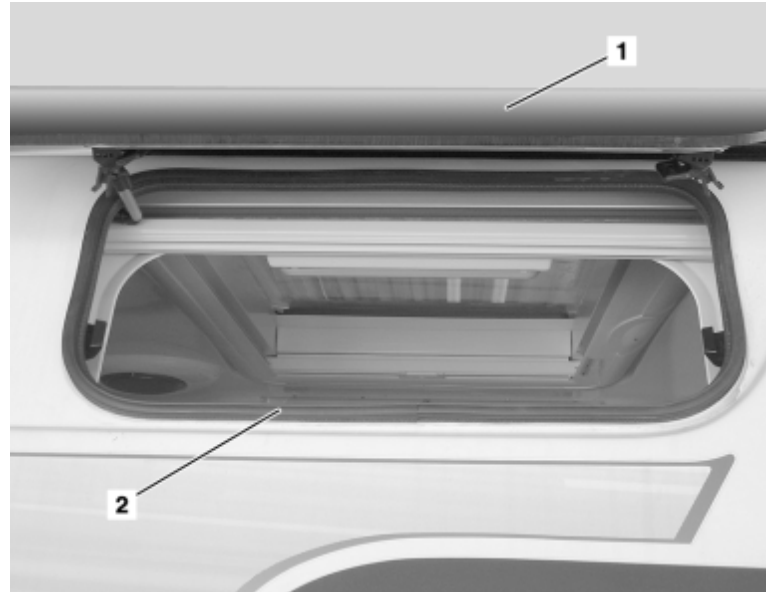

D67.30-0068-11

	Remove		
Danger!	Risk of death caused by falling from vehicle roof. Risk of injury to other persons caused by falling objects during work in roof area.	Perform work on and in area of vehicle roof only with suitable aids (ladders, scaffolding, assembly platforms). Sufficiently secure working area	AS65.00-Z-0002-01B
1	Open vent window (1) and arrest		
2	Remove sealing frame (2) from outside		
3	Remove sealant from high roof		
	Install		
4	Install sealing frame (2)		
5	Apply sealant	Apply sealant to joint of sealing frame (2)	
		Dirko Transparent sealant	BR00.45-Z-1050-01A
6	Close vent window (1)		

Auxiliary repair materials

Number	Designation	Order number
BR00.45-Z-1050-01A	Dirko Transparent sealant	001 989 24 20

MODEL 903.662

with CODE (ZU8) National version for USA

with CODE (Z29) "James Cook" touring camper, NAFTA

Left bottom center vent window

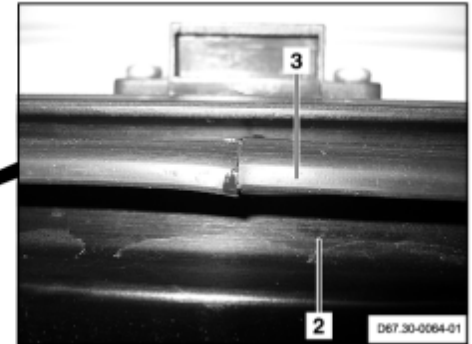
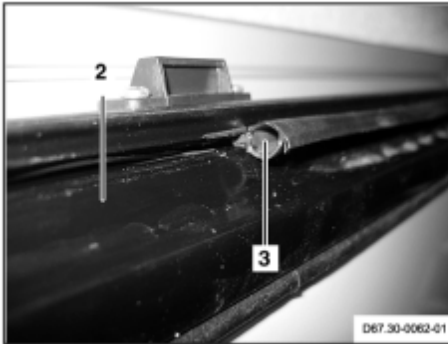

D67.30-0065-07

1 Left bottom center vent window

2 Window frame

3 Sealing rubber

	Remove		
Danger!	Injury hazard by pinching or cutting off extremities with doors, covers, flaps and loose components	Keep limbs away from motion area when moving doors, covers, flaps and components. Wear protective gloves	AS00.00-Z-0025-01A
1	Open left bottom center vent window (1)	See Operating Instructions	
2	Pull sealing rubber (3) out of window frame (2)		
	Install		
3	Insert sealing rubber (3) into window frame (2) starting in center at bottom	Do not stretch or shorten sealing rubber (3), otherwise it can retract after installation, resulting in leakage	
		Spray sealing rubber (3) with lubricant to facilitate installation.	
			BR00.45-Z-1039-06A
4	Glue ends of sealing rubber (3) to one another		BR00.45-Z-1004-02A
5	Close left bottom center vent window (1)	See Operating Instructions	

6	Carry out leak checks	
---	-----------------------	--

Auxiliary repair materials

Number	Designation	Order number
BR00.45-Z-1004-02A	MB-special adhesive for bonding textiles, carpets, imitation leather, foamed parts, sealing rubber frames, felt, with each other and with sheet metal (750 ml can)	000 989 82 71
BR00.45-Z-1039-06A	Lubricant	000 989 11 60

MODEL 903.662

with CODE (ZU8) National version for USA

with CODE (Z29) "James Cook" touring camper, NAFTA

1 Vent windows

2 Screw

3 Bolts

4 Arrester

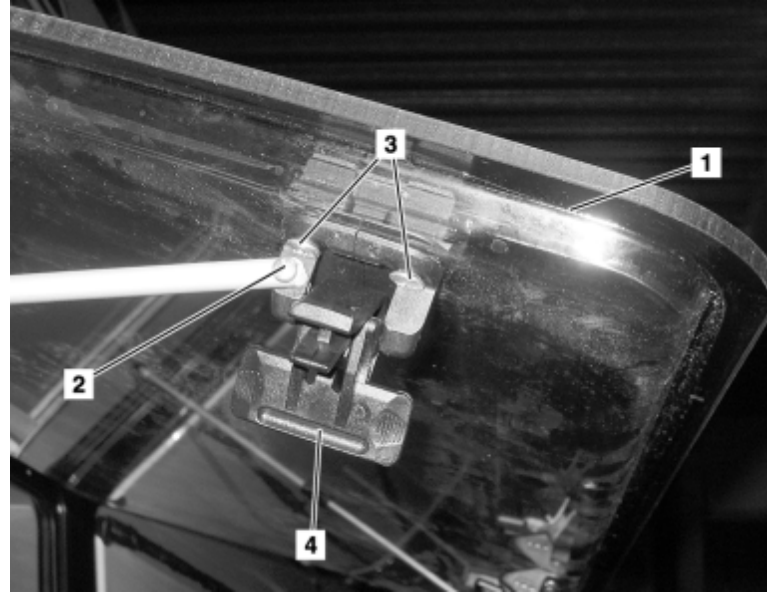

D67.30-0066-11

☒ ☒	Remove/Install		
1	Open vent window (1)		
2	Unscrew bolt (2).		
3	Remove bolts (3)		
4	Remove arrester (4)		
5	Install in the reverse order		

MODEL 903.662

with CODE (ZU8) National version for USA

with CODE (Z29) "James Cook" touring camper, NAFTA



1 Vent windows

2 Screw

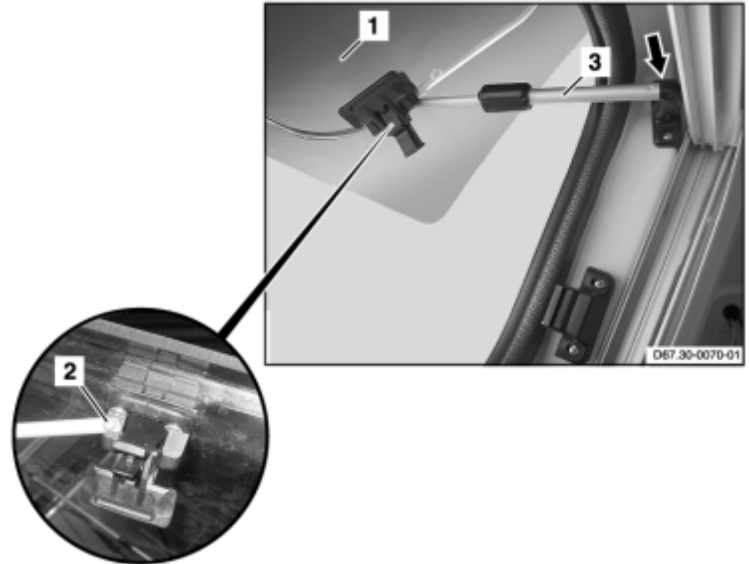
3 Support



D67.30-0069-11

	Remove/Install		
1	Open vent window (1)		
2	Unscrew bolt (2).		
3	Unhook support (3) at top (arrow)	 Mounting wedge	110 589 03 59 00
4	Remove support (3)		
5	Install in the reverse order		



110 589 03 59 00

Mounting wedge

MODEL 903.662

with CODE (ZU8) National version for USA



with CODE (Z29) "James Cook" touring camper, NAFTA
left paneling

1 Cup holder

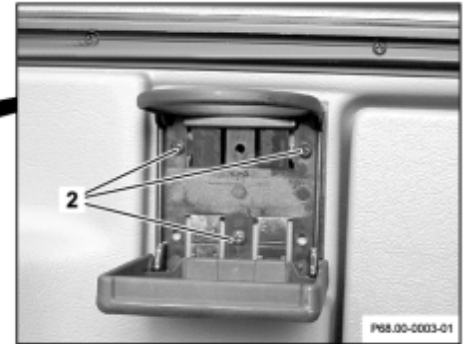
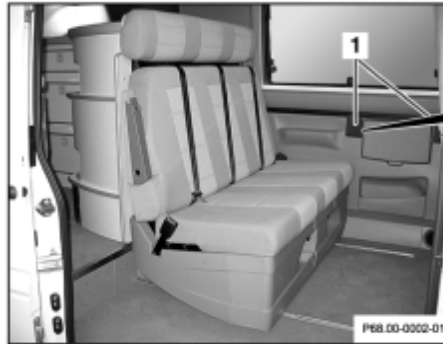
2 Bolts



D68.00-0001-04

 	Remove/Install		
1	Open cup holder (1)		
2	Remove bolts (2)		
3	Remove cup holder (1)		
4	Install in the reverse order		

MODEL 903.662

with CODE (ZU8) National version for USA

with CODE (Z29) "James Cook" touring camper, NAFTA

- 1 Bolts
- 2 Bracket
- 3 Rivets
- 4 Bracket
- 5 Bolts
- 6 Protective strip

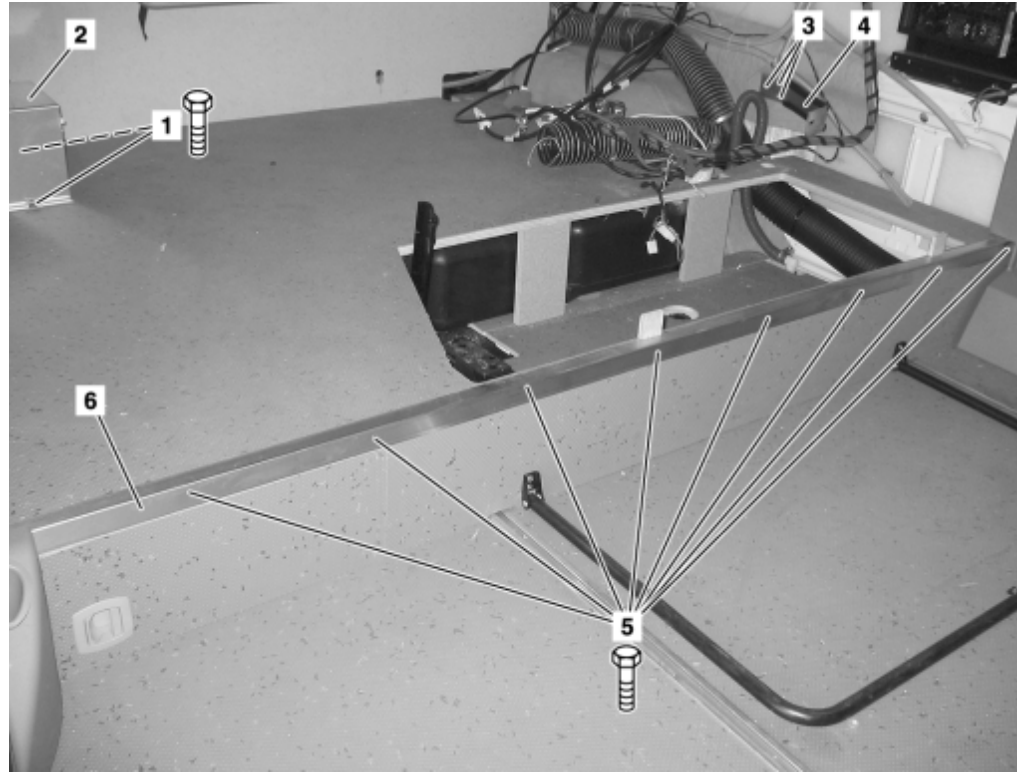

D68.20-1108-06

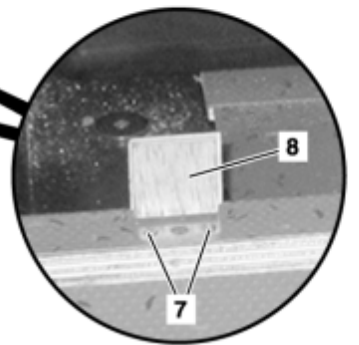
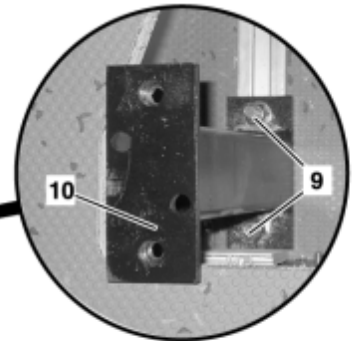
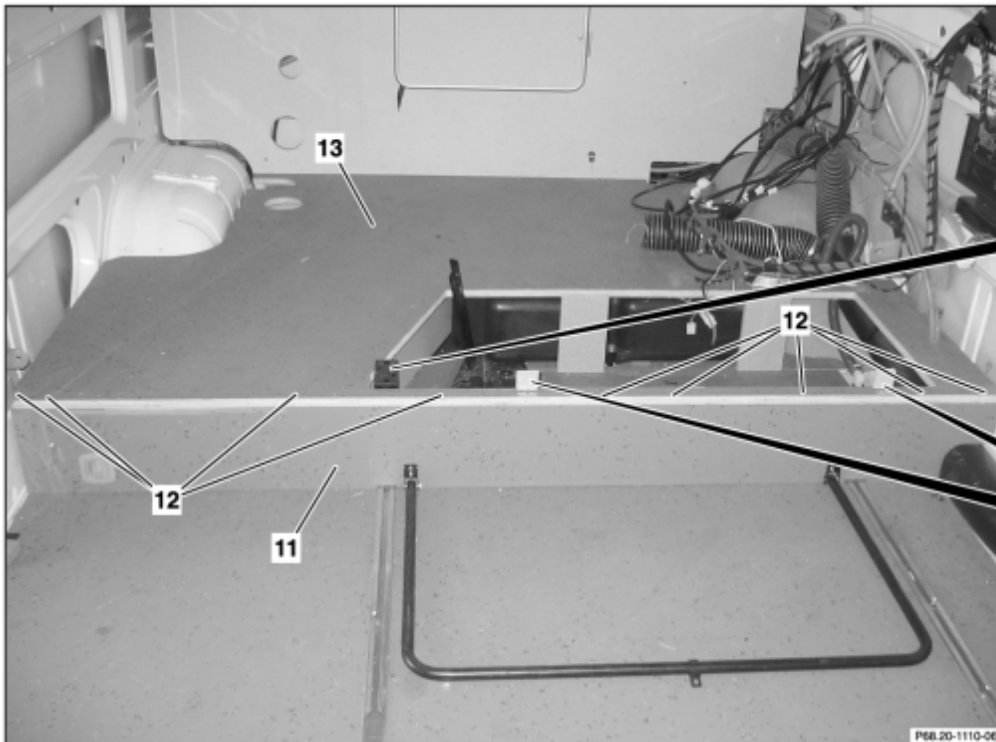

7 Bolts
8 Angles
9 Nuts





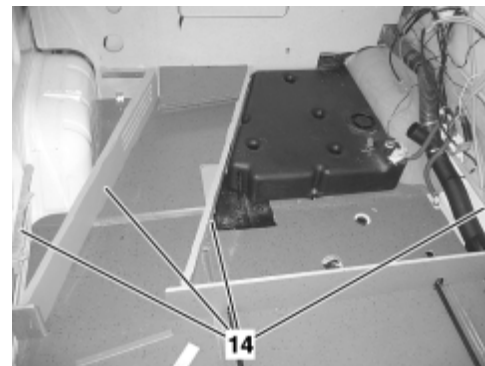

10 Belt support base
11 Flap



12 Bolts
13 Platform floor

14 Supports



D68.20-1111-01

	Remove/Install		
 Danger!	Risk of injury caused by scraping or cutting body parts on sharp vehicle parts	Always wear protective gloves when working on or near sharp and undeurred vehicle parts. Deburr replacement panels.	AS00.00-Z-0017-01B
 Danger!	Injury hazard by pinching or cutting off extremities with doors, covers, flaps and loose components	Keep limbs away from motion area when moving doors, covers, flaps and components. Wear protective gloves	AS00.00-Z-0025-01A
1	Remove fresh water tank		AR86.30-D-0060A
2	Remove side wall lining	Bottom side wall paneling	AR68.30-D-1450A
3	Remove excrement tank		AR86.30-D-0073A
4	Remove stowage cabinet	Refrigerator box	AR86.60-D-0045A
5	Remove screws (1)		
6	Remove bracket (2) for refrigerator box stowage cabinet	 Installation: Fasten bracket (2) on wheelhouse with suitable glue.	
7	Drill out rivets (3)		
	General information on riveting	Model 168, 169, 171, 199, 203, 209, 211, 215, 219, 230, 240, 414, 639, 903	AH60.00-P-0003-01N
		 PowerBird blind rivet tool	WH58.30-Z-1003-29A

		 Hand riveter	WH58.30-Z-1005-29A
		Drill (electric/pneumatic)	WE58.40-Z-1001-03A
		Wet/dry vacuum cleaner	WE58.40-Z-1005-03A
		4.9 x 24 blind rivet	BR00.45-Z-1014-13A
8	Remove bracket (4) for fresh water tank		
9	Unscrew bolts (5).		
10	Remove protective strip (6).		
11	Unscrew bolts (7).		
12	Remove bracket (8)		
13	Unscrew nuts (9).		
14	Remove belt support base (10)		
15	Open flap (11) and remove		
16	Unscrew bolts (12).		
17	Detach platform floor (13) and remove	 Installation: Remove old glue residues from supports (14) and apply new suitable glue	
18	Install in the reverse order		

Commercially available tools (see Workshop Equipment Manual)

Number	Designation	Make (e. g.)	Order number
WH58.30-Z-1003-29A	PowerBird blind rivet tool	Gesipa Blindniettechnik GmbH Nordenstraße 13-39 D-64546 Mörfelden - Walldorf	72 400 31
WH58.30-Z-1005-29A	Hand riveter	Gesipa Blindniettechnik GmbH Nordenstraße 13-39 D-64546 Mörfelden - Walldorf	70 100 01

Workshop equipment/MB testers (see Workshop Equipment Manual)

--	--

WE58.40-Z-1001-03A	Drill (electric/pneumatic)
WE58.40-Z-1005-03A	Wet/dry vacuum cleaner

Auxiliary repair materials

Number	Designation	Order number
BR00.45-Z-1014-13A	4.9 x 24 blind rivet	A 002 990 43 97

MODEL 903.662

with CODE (ZU8) National version for USA

with CODE (Z29) "James Cook" touring camper, NAFTA

Side wall paneling folding table

1 Folding table

2 Bolts

3 Bolts

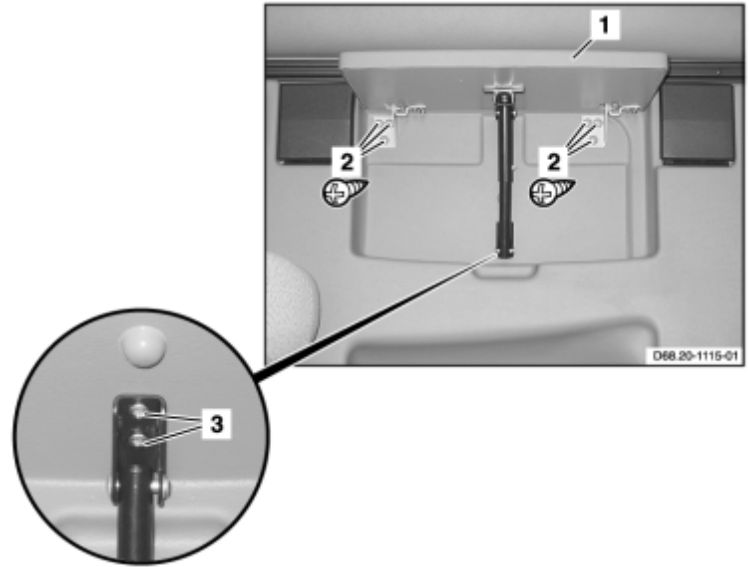

D68.20-1114-11

☒ ☒	Remove/Install		
1	Fold up folding table (1)		
2	Remove caps from bolts (2)		
3	Unscrew bolts (2)		
4	Pivot folding table (1) downward		
5	Remove bolts (3)		
6	Remove folding table (1)		
7	Install in the reverse order		

MODEL 903.662

with CODE (ZU8) National version for USA

with CODE (Z29) "James Cook" touring camper, NAFTA

Folding table support in side wall paneling

1 Folding table

2 Bolts

3 Folding table support

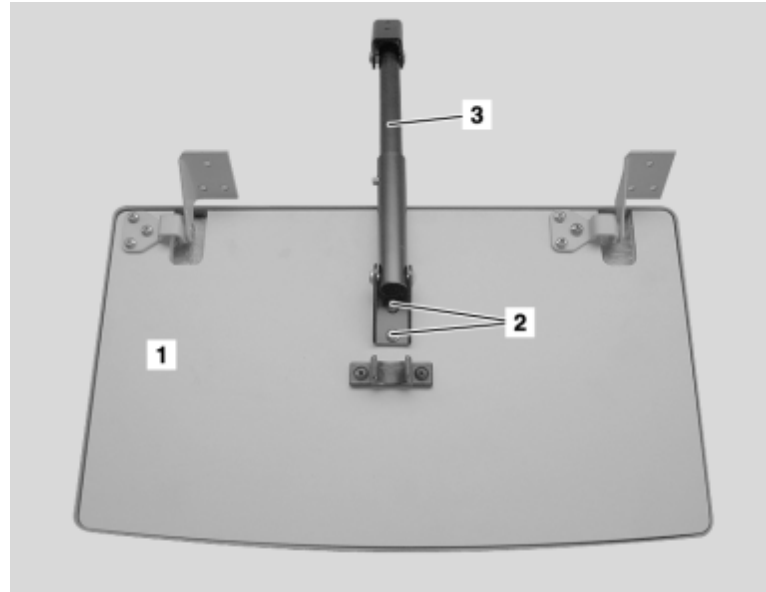

D68.20-1113-11

☒ ☒	Remove/Install		
1	Remove folding table (1)	Side wall paneling folding table	AR68.20-D-8305A
2	Unscrew bolts (2)		
3	Remove folding table support (3)		
4	Install in the reverse order		

MODEL 903.662

with CODE (ZU8) National version for USA

with CODE (Z29) "James Cook" touring camper, NAFTA

Folding table hinge in side wall paneling

1 Folding table

2 Bolts

3 Hinge

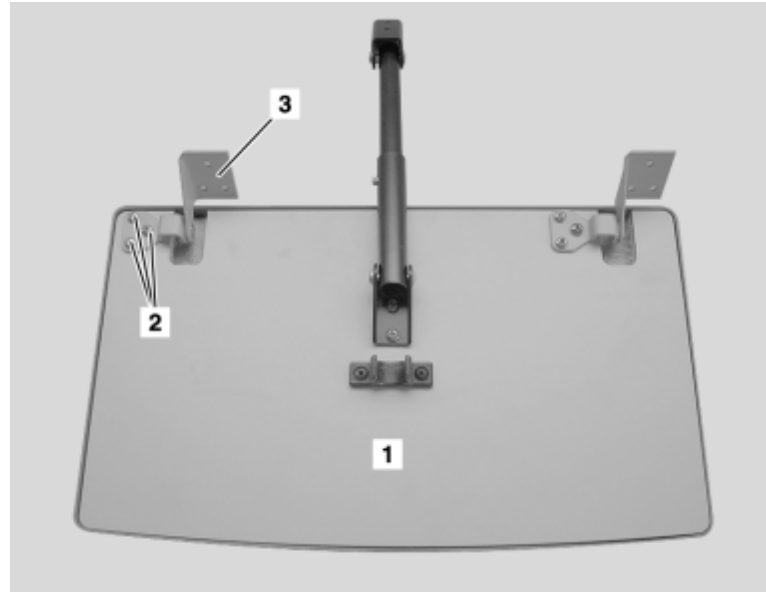

D68.20-1112-11

☒ ☒	Remove/Install		
1	Remove folding table (1)	Side wall paneling folding table	AR68.20-D-8305A
2	Unscrew bolts (2)		
3	Remove hinge (3)		
4	Install in the reverse order		

MODEL 903.662

with CODE (ZU8) National version for USA

with CODE (Z29) "James Cook" touring camper, NAFTA

1 Table compartment strip

2 Bolts

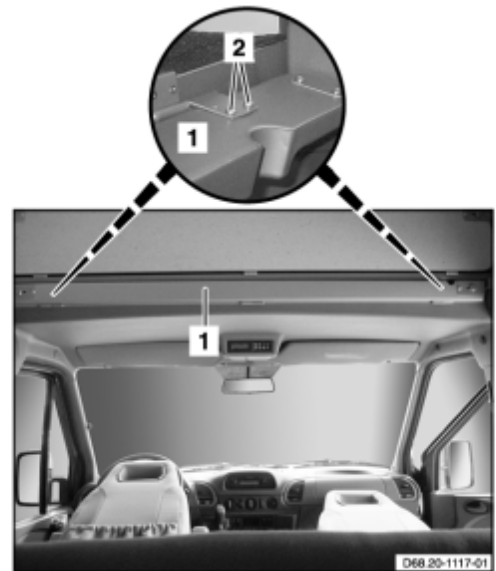

D68.20-1116-11

☒ ☒	Remove/Install		
1	Unlock table compartment strip (1) and fold open		
2	Unscrew bolts (2)		
3	Remove table compartment strip (1)		
4	Install in the reverse order		

MODEL 903.662

with CODE (ZU8) National version for USA

with CODE (Z29) "James Cook" touring camper, NAFTA

1 Table compartment strip

2 Bolts

3 Table compartment bracket

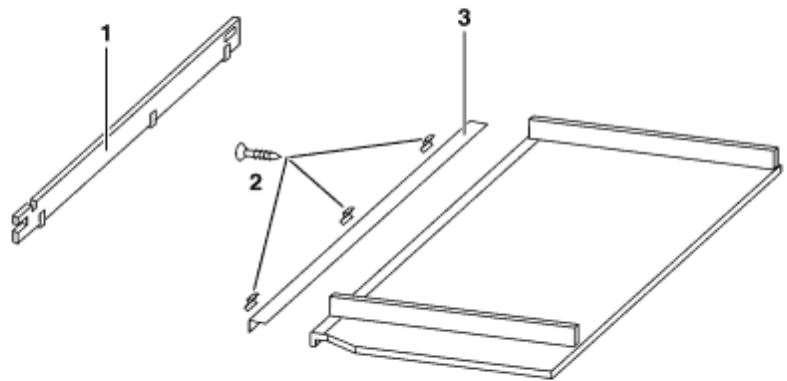

D68.20-1118-06

☒ ☒	Remove/Install		
1	Unlock table compartment strip (1) and fold open		
2	Unscrew bolts (2)		
3	Remove table compartment strip (1)		
4	Remove table compartment bracket (3)		
5	Install in the reverse order		

MODEL 903.662

with CODE (ZU8) National version for USA

with CODE (Z29) "James Cook" touring camper, NAFTA

- 1 Table foot
- 2 Bolts
- 3 Lock button
- 4 Bolts
- 5 Fastening strip

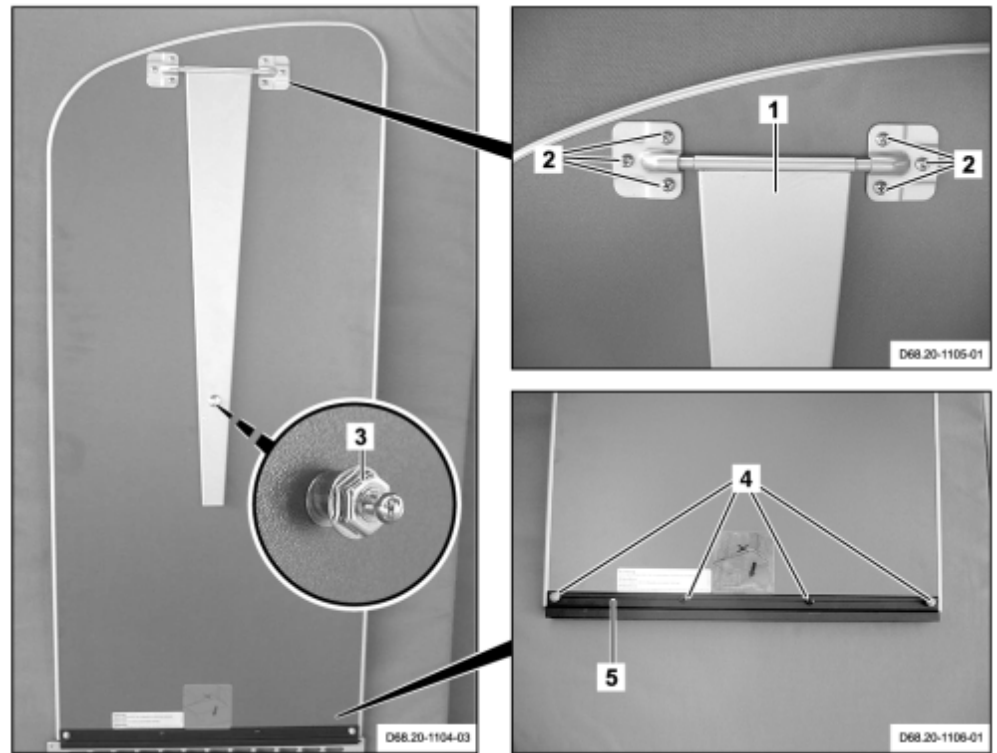

D68.20-1107-06

	Disassemble/assemble		
1	Unlock table foot (1)		
2	Unscrew bolts (2)		
3	Remove table foot (1)		
4	Unscrew lock button (3)		
5	Remove caps from bolts (4)		
6	Remove bolts (4).		
7	Remove fastening strip (5)		
8	Assemble in reverse order		

MODEL 903.662

with CODE (ZU8) National version for USA

with CODE (Z29) "James Cook" touring camper, NAFTA

Bottom side wall paneling

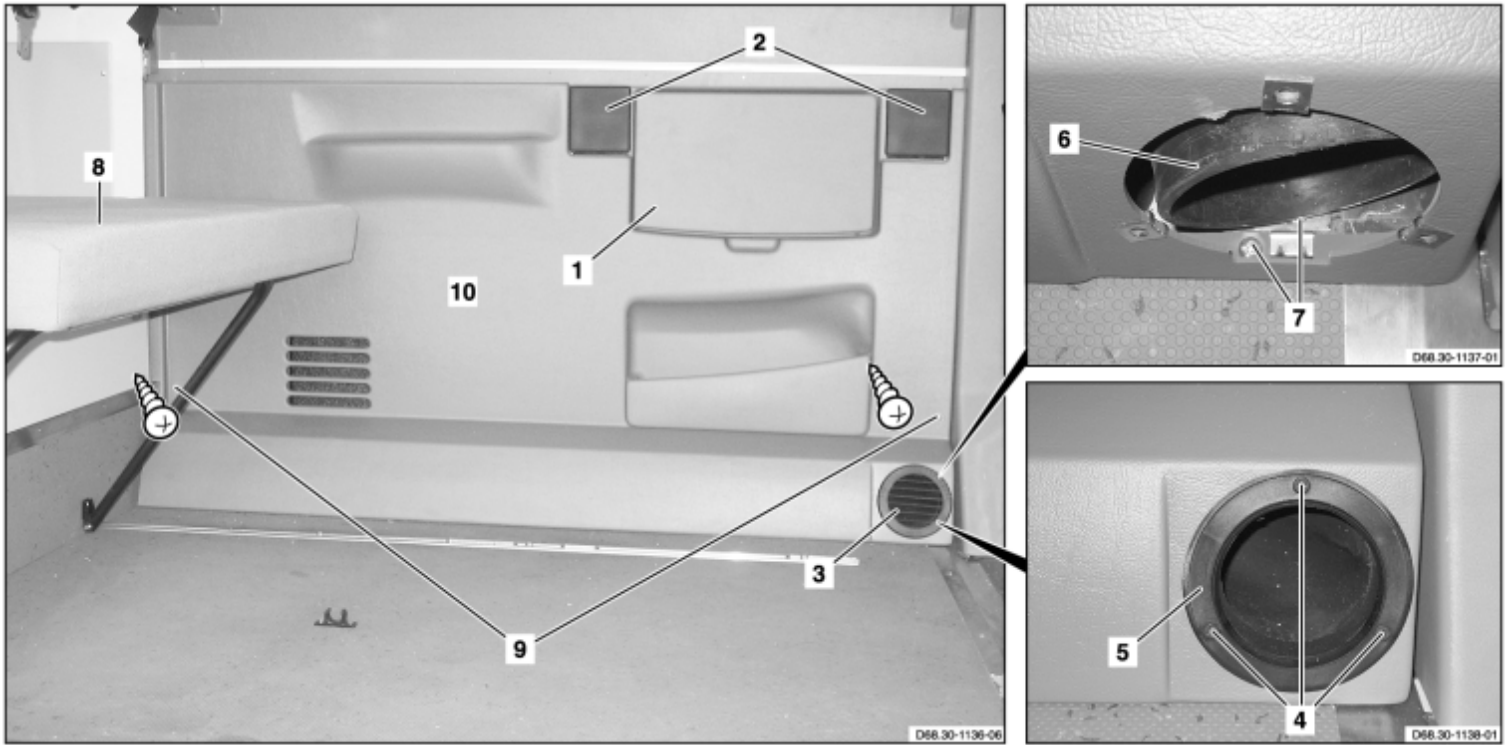

D68.30-1135-09

1 Folding table
2 Cup holder
3 Vent grille
4 Bolts

5 Air vent
6 Air hose
7 Bolts

8 Bed extension
9 Bolts
10 Side wall lining

☒ ☒	Remove/Install		
⚠ Danger!	Risk of injury caused by scraping or cutting body parts on sharp vehicle parts	Always wear protective gloves when working on or near sharp and undeurred vehicle parts. Deburr replacement panels.	AS00.00-Z-0017-01B
1	Remove bench		AR91.21-D-4000A
2	Remove folding table (1)	Side wall lining folding table	AR68.20-D-8305A
3	Remove cup holder (2)	Left paneling	AR68.00-D-1000A

4	Remove left center vent window paneling	Lower paneling	AR68.30-D-1510A
5	Unclip vent grille (3) and remove	 Mounting wedge	110 589 03 59 00
6	Remove bolts (4).		
7	Remove air vent (5)		
8	Slide air hose (6) to side		
9	Unscrew bolts (7).		
10	Install bed extension (8)		
11	Remove caps from screws (9)		
12	Unscrew screws (9)		
13	Remove side wall lining (10).		
14	Install in the reverse order		



110 589 03 59 00

Mounting wedge

MODEL 903.662

with CODE (ZU8) National version for USA

with CODE (Z29) "James Cook" touring camper, NAFTA

Top side wall lining

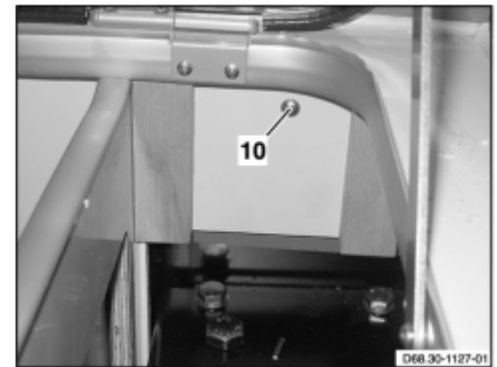
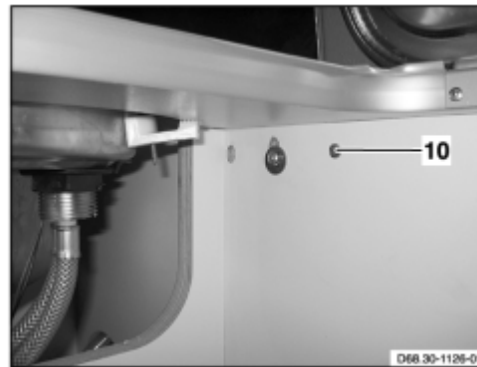
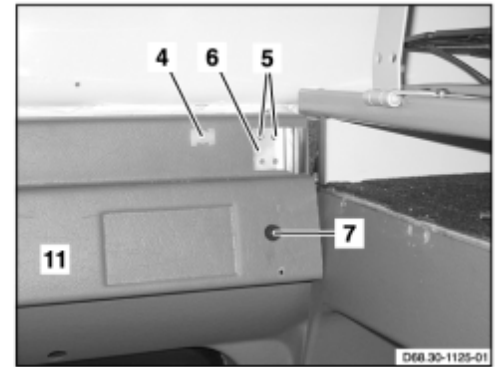
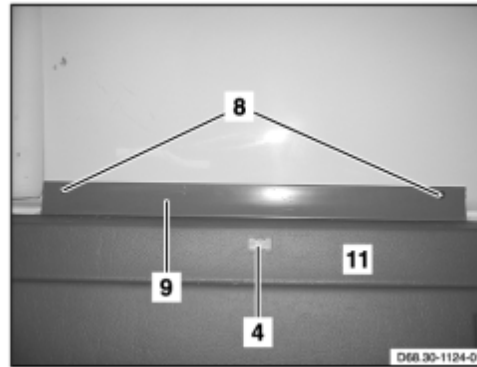
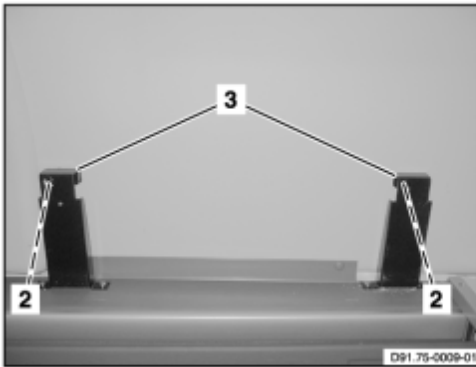



D68.30-1123-09

2 Bolts
3 Bracket
4 Clamps
5 Bolts

6 Latch element
7 Rubber base
8 Bolts

9 Covering
10 Bolts
11 Side wall lining

☒ ☒	Remove/Install		
⚠ Danger!	Risk of injury caused by scraping or cutting body parts on sharp vehicle parts	Always wear protective gloves when working on or near sharp and undebrurred vehicle parts. Deburr replacement panels.	AS00.00-Z-0017-01B
1	Remove bench		AR91.21-D-4000A
2	Remove hanging cabinet	Longitudinal hanging cabinet	AR86.60-D-0051B
3	Remove heat shield from boiler		AR86.60-D-0012A

4	Remove roller sun blind	On left center vent window	AR68.50-D-3400A
5	Remove bed plate guide rail	Left guide rail	AR91.75-D-7765A
6	Unscrew bolts (2)		
7	Remove bracket (3)		
8	Remove table compartment strip		AR68.20-D-8310A
9	Remove trim strip from left roof frame		AR68.30-D-4485A
10	Unclip clamps (4) from trim strip on roof frame	 Mounting wedge	110 589 03 59 00
11	Unscrew bolts (5).		
12	Remove latch element (6)		
13	Remove rubber base (7)		
14	Unscrew bolts (8).		
15	Remove cover (9)		
16	Remove utensil insert		AR86.60-D-0022A
17	Unscrew bolts (10).		
18	Remove side wall lining (11)	 Installation: When replacing side wall lining (11), transfer hole intervals of clamps (4) to new side wall lining (11) and drill holes	
19	Remove glue residues	 Installation: Mask cleaned gluing points on roof frame and bottom window cutout with suitable adhesive tape.	
20	Install in the reverse order		



110 589 03 59 00

Mounting wedge

MODEL 903.662

with CODE (ZU8) National version for USA

with CODE (Z29) "James Cook" touring camper, NAFTA

Bottom paneling

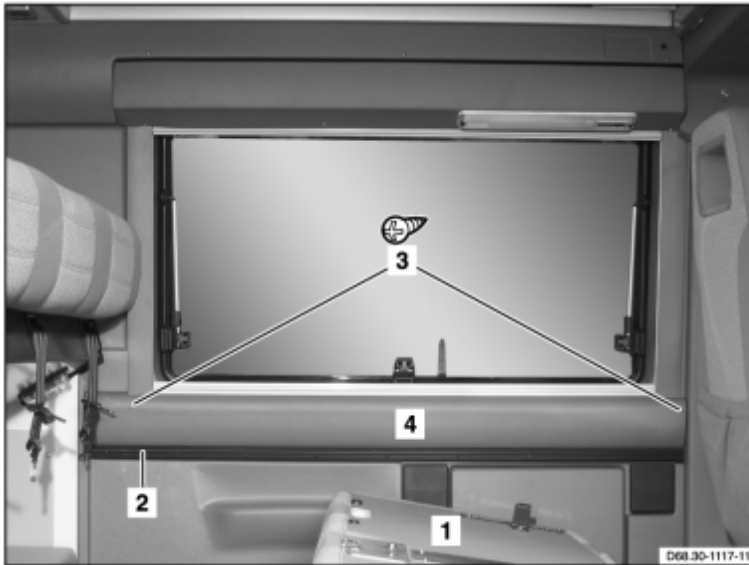

D68.30-1118-08

1 Backrest
2 Fastening strip

3 Bolts

4 Lower paneling

☒ ☒	Remove/Install		
⚠ Danger!	Risk of injury caused by body parts becoming jammed, pinched or severed by doors, covers, flaps or by loose components	Keep body parts well clear when moving doors, covers, flaps and components. Wear protective gloves and protective shoes.	AS00.00-Z-0025-01A
1	Fold bench seat backrest (1) down		
2	Remove fastening strip (2) for table		AR86.60-D-0033A
3	Remove bolt caps (3)		
4	Remove bolts (3)		
5	Remove bottom paneling (4)		
6	Install in the reverse order		

MODEL 903.662

with CODE (ZU8) Version for USA

with CODE (Z29) "James Cook" touring camper, NAFTA

Upper trim

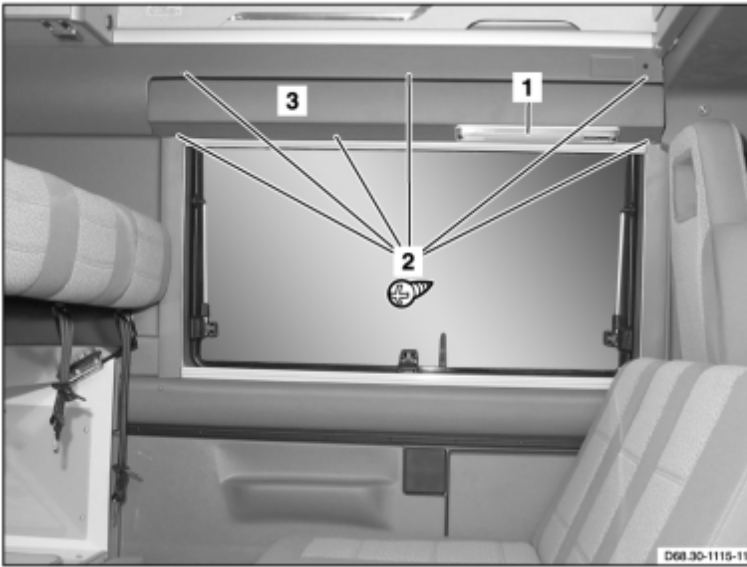



D68.30-1116-08

1 Transistor lamp

2 Bolts

3 Upper trim

 	Remove/Install		
1	Remove transistor lamp (1)		AR82.20-D-1015A
2	Remove caps from bolts (2)		
3	Remove bolts (2)		
4	Remove upper trim (3)		
5	Install in the reverse order		

MODEL 903.662

with CODE (ZU8) National version for USA

with CODE (Z29) "James Cook" touring camper, NAFTA

Side high roof vent window

- 1 Bolts
- 2 Lamp bracket
- 3 Protective net bracket
- 4 Bolts
- 5 Paneling

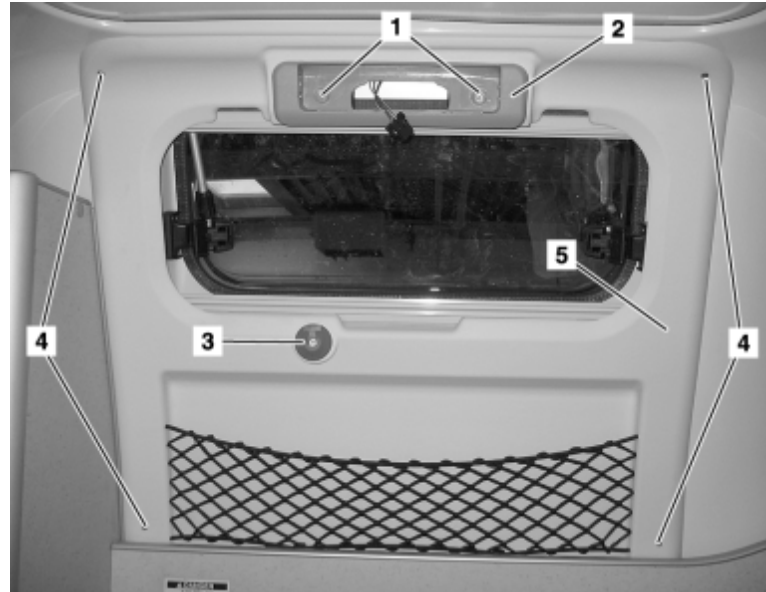

D68.30-1131-11

☒ ☒	Remove/Install		
⚠ Danger!	Risk of injury caused by scraping or cutting body parts on sharp vehicle parts	Always wear protective gloves when working on or near sharp and undeurred vehicle parts. Deburr replacement panels.	AS00.00-Z-0017-01B
1	Remove high roof vent window lamp		AR82.20-D-1017A
2	Remove screws (1)		
3	Remove lamp bracket (2)		
4	Remove protective net bracket (3)	High roof bed protective net	AR91.75-D-7735A
5	Remove caps from bolts (4)		
6	Remove bolts (4).		
7	Remove paneling (5)		
8	Install in the reverse order		

MODEL 903.662

with CODE (ZU8) National version for USA

with CODE (Z29) "James Cook" touring camper, NAFTA

Side high roof vent window

1 Paneling

2 Clamps

3 Luggage net

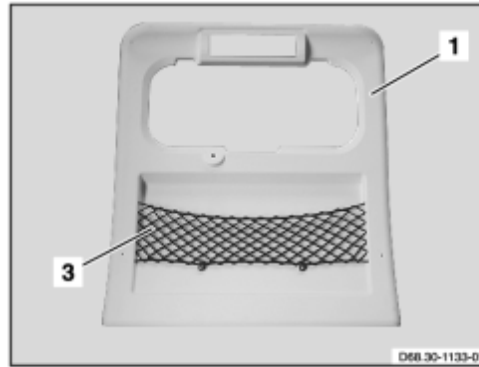

D68.30-1132-05

☒ ☒	Remove/Install		
1	Remove paneling (1)		AR68.30-D-1550A
2	Remove clamps (2) through holes		
3	Remove luggage net (3)		
4	Install in the reverse order		

MODEL 903.662

with CODE (ZU8) National version for USA

with CODE (Z29) "James Cook" touring camper, NAFTA

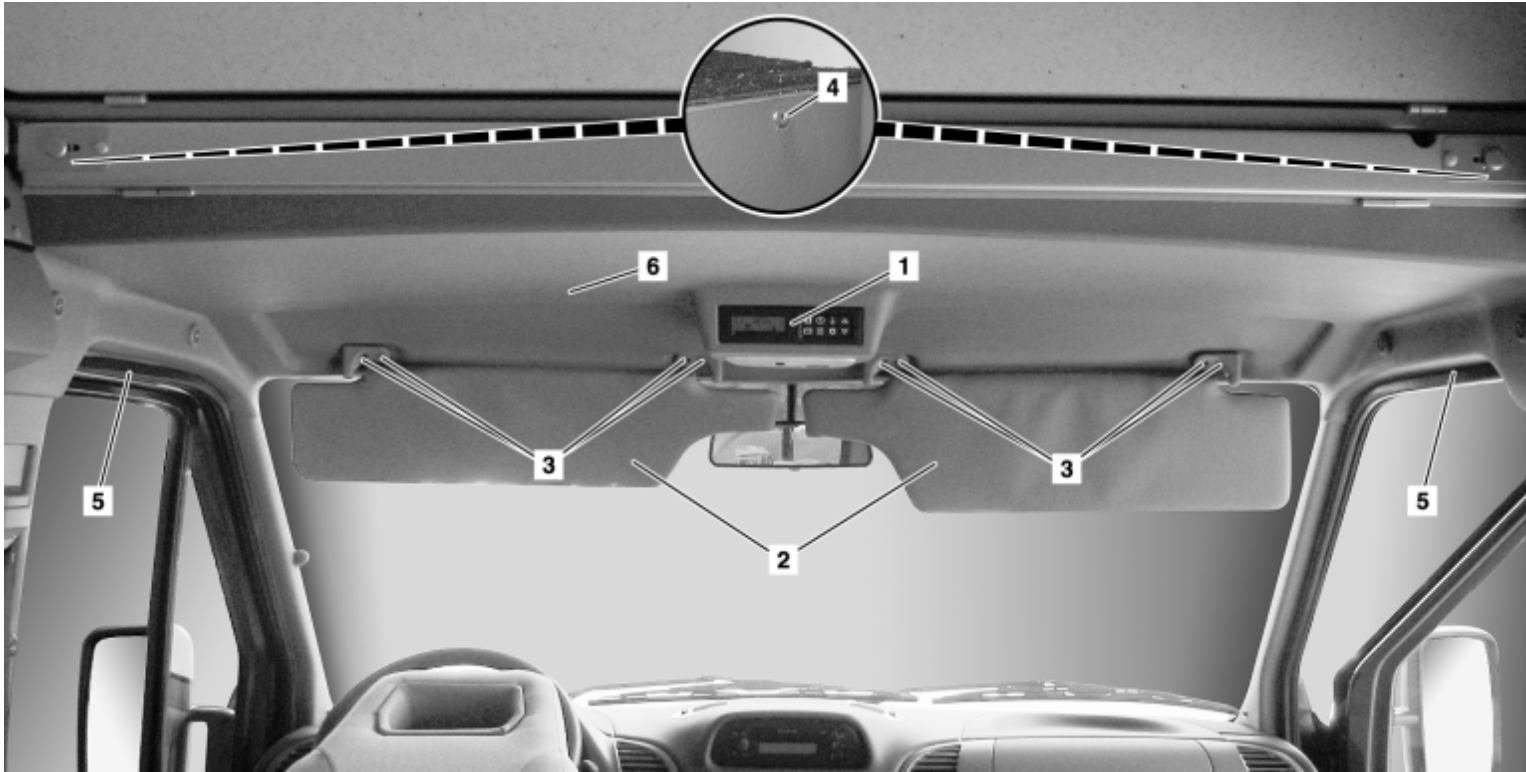

D68.30-1134-09

1 Central electronics

2 Sun visors







3 Bolts

4 Blind rivet

5 Door rubber seals

6 Headliner

	Remove		
	Danger!	Risk of injury caused by scraping or cutting body parts on sharp vehicle parts	Always wear protective gloves when working on or near sharp and undebrurred vehicle parts. Debrurr replacement panels.
1	Remove central electronic circuitry (1)		AR54.21-D-0019A
2	Fold sun visors (2) toward front		
3	Remove bolts (3)		
4	Remove sun visors (2)		
5	Remove cable compartment bracket		AR68.20-D-8311A
6	Drill out blind rivet (4)	Drill (electric/pneumatic)	WE58.40-Z-1001-

			03A
		Wet/dry vacuum cleaner	WE58.40-Z-1005-03A
7	Remove door rubber seals (5) in upper area of door		
8	Remove headliner (6)	 Helper required	
	Install		
9	Install headliner (6)		
10	Install door rubber seals (5) in upper area of door		
11	Rivet in blind rivet (4)	 Use suitable blind rivet (4)	
	General information on riveting	Model 168, 169, 171, 199, 203, 209, 211, 215, 219, 230, 240, 414, 639, 903	AH60.00-P-0003-01N
		 PowerBird blind rivet tool	WH58.30-Z-1003-29A
		 Hand riveter	WH58.30-Z-1005-29A
12	Remove table compartment bracket		AR68.20-D-8311A
13	Install sun visors (2)		
14	Screw in screws (3)		
15	Fold sun visors (2) upward		
16	Install central electronics (1)		AR54.21-D-0019A

Commercially available tools (see Workshop Equipment Manual)

Number	Designation	Make (e. g.)	Order number
WH58.30-Z-1003-29A	PowerBird blind rivet tool	Gesipa Blindniettechnik GmbH Nordenstraße 13-39 D-64546 Mörfelden - Walldorf	72 400 31
WH58.30-Z-1005-29A	Hand riveter	Gesipa Blindniettechnik GmbH Nordenstraße 13-39 D-64546 Mörfelden -	70 100 01

Workshop equipment/MB testers (see Workshop Equipment Manual)

WE58.40-Z-1001-03A	Drill (electric/pneumatic)
--------------------	----------------------------

WE58.40-Z-1005-03A	Wet/dry vacuum cleaner
--------------------	------------------------

MODEL 903.662

with CODE (ZU8) National version for USA

with CODE (Z29) "James Cook" touring camper, NAFTA





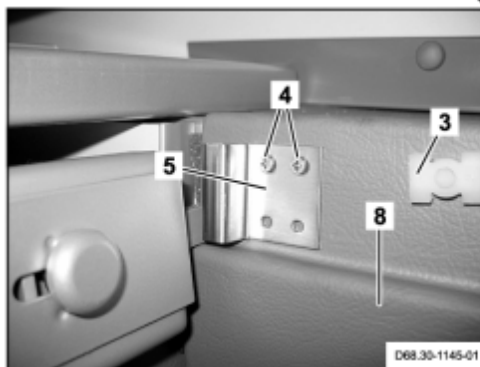
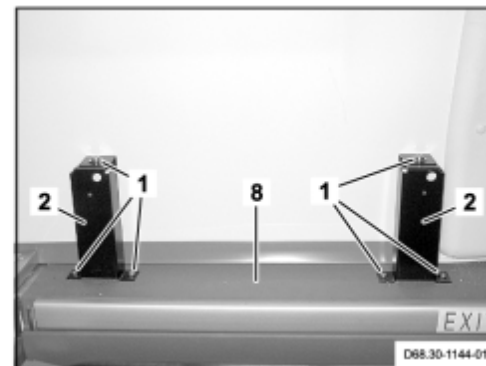
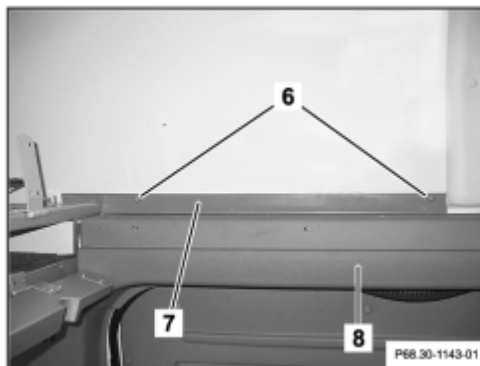

Above right sliding door

- 1 Bolts
- 2 Bracket
- 3 Clip
- 4 Bolts
- 5 Bracket
- 6 Bolts
- 7 Trim strip
- 8 Roof frame paneling



D68.30-1147-06

☒ ☒	Remove/Install		
⚠ Danger!	Risk of injury caused by scraping or cutting body parts on sharp vehicle parts	Always wear protective gloves when working on or near sharp and undeurred vehicle parts. Deburr replacement panels.	AS00.00-Z-0017-01B
1	Remove bed plate guide rail	Right guide rail	AR91.75-D-7765B
2	Remove screws (1)		
3	Remove bracket (2)		
4	Remove trim strip from right roof frame paneling (8)	i If necessary, remove clip (3) remaining in roof frame paneling (8)	AR68.30-D-4485A
		i Installation: Replace damaged clip (3)	
5	Remove bolts (4).		

6	Remove bracket (5)		
7	Remove caps from bolts (6)		
8	Unscrew bolts (6)		
9	Remove trim strip (7)	 Installation: Remove adhesive tape residues from trim strip (7) Clean gluing surfaces on trim strip (7) and on roof frame paneling (8)Install new double-sided adhesive tape on trim strip (7)	
			BR00.45-Z-1014-04A
10	Remove door frame seal	 Only in area of roof frame paneling (8).	
11	Remove interior illumination switch from roof frame paneling (8)		AR82.20-D-1011A
12	Loosen roof frame paneling (8) from roof frame	 The roof frame paneling (8) cannot be removed without damage.	
		 The roof frame paneling (8) is fastened to the roof frame with double-sided adhesive tape	
		 Hot-air gun - 3000 W	WH58.30-Z-1014-20A
13	Remove roof frame paneling (8)	 Installation: Remove adhesive tape residues from roof frame.Clean gluing surfaces on roof frame and on new roof frame paneling (8)Install double-sided adhesive tape on new roof frame paneling (8).	
		Adhesive cleaner	BR00.45-Z-1014-04A
14	Install in the reverse order		

Commercially available tools (see Workshop Equipment Manual)

Number	Designation	Make (e. g.)	Order number
WH58.30-Z-1014-20A	Hot air gun - 3000 W	Zinser Schweißtechnik GmbH Postfach 14 40 D-73061	Model K-25-R

Ebersbach/Fils Tel.: 07163/16710
--

Auxiliary repair materials

Number	Designation	Order number
BR00.45-Z-1014-04A	Adhesive cleaner	003 989 72 71

MODEL 903.662

with CODE (ZU8) National version for USA

with CODE (Z29) "James Cook" touring camper, NAFTA

Above rear right side window

- 1 Screw
- 2 Bolts
- 3 Trim strip
- 4 Roof frame paneling

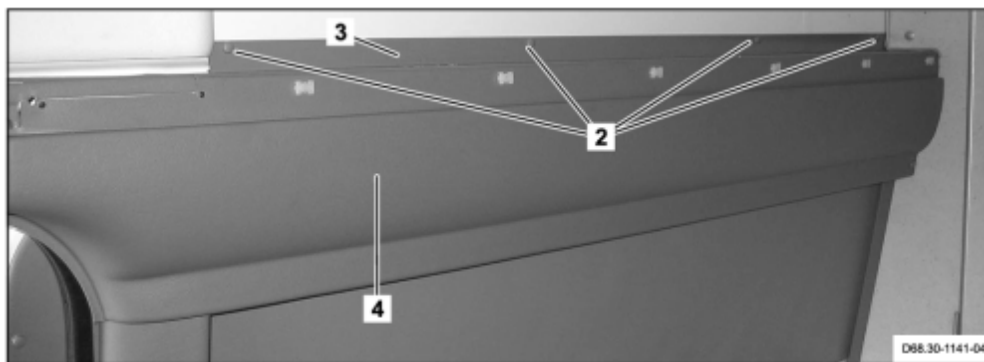
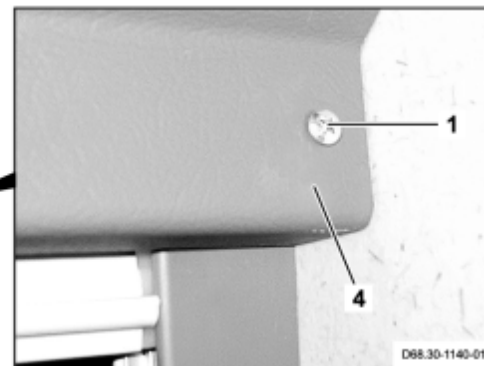

D68.30-1142-06

☒ ☒	Remove/Install		
⚠ Danger!	Risk of injury caused by scraping or cutting body parts on sharp vehicle parts	Always wear protective gloves when working on or near sharp and undeurred vehicle parts. Deburr replacement panels.	AS00.00-Z-0017-01B
1	Remove bed plate guide rail	Right guide rail	AR91.75-D-7765B
2	Remove trim strip from right roof frame paneling (4)	i If necessary remove remaining clips from roof frame paneling (4).	AR68.30-D-4485A
		i Installation: Replace damaged remaining clips	
3	Remove cap from bolt (1)		
4	Remove bolt (1)		
5	Remove caps from bolts (2)		

6	Unscrew bolts (2)		
7	Remove trim strip (3)	i Installation: Remove adhesive tape residues from trim strip (3) Clean gluing surfaces on trim strip (3) and on roof frame paneling (4) Install new double-sided adhesive tape on trim strip (3)	
		Adhesive cleaner	BR00.45-Z-1014-04A
8	Remove door frame seal	i Only in area of roof frame paneling.	
9	Loosen roof frame paneling (4) from roof frame	i The roof frame paneling (4) cannot be removed without damage	
		i The roof frame paneling (4) is fastened to the roof frame with double-sided adhesive tape	
		 Hot-air gun - 3000 W	WH58.30-Z-1014-20A
10	Remove roof frame paneling (4)	i Installation: Remove adhesive tape residues from roof frame. Clean gluing surfaces on roof frame and on new roof frame paneling (4) Install double-sided adhesive tape on new roof frame paneling (4).	
			BR00.45-Z-1014-04A
11	Install in the reverse order		

Commercially available tools (see Workshop Equipment Manual)

Number	Designation	Make (e. g.)	Order number
WH58.30-Z-1014-20A	Hot air gun - 3000 W	Zinser Schweißtechnik GmbH Postfach 14 40 D-73061 Ebersbach/Fils Tel.: 07163/16710	Model K-25-R

Auxiliary repair materials

Number	Designation	Order number
--------	-------------	--------------

BR00.45-Z-1014-
04A

Adhesive cleaner

003 989 72 71

MODEL 903.662

with CODE (ZU8) National version for USA



with CODE (Z29) "James Cook" touring camper, NAFTA

1 Trim strip

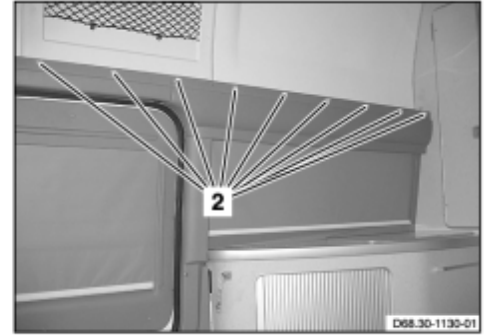
2 Clamps



D68.30-1128-04

	Remove/Install		
1	Unclip trim strip (1) and remove	 Installation: Check clamps (2); replace if necessary.	
		 Mounting wedge	110 589 03 59 00
2	Install in the reverse order		



110 589 03 59 00

Mounting wedge

MODEL 903.662

with CODE (ZU8) National version for USA

with CODE (Z29) "James Cook" touring camper, NAFTA

Right side

1 Rubber seal

2 Bolts

3 Pushbutton counter piece

4 C-pillar paneling

5 Electrical connector

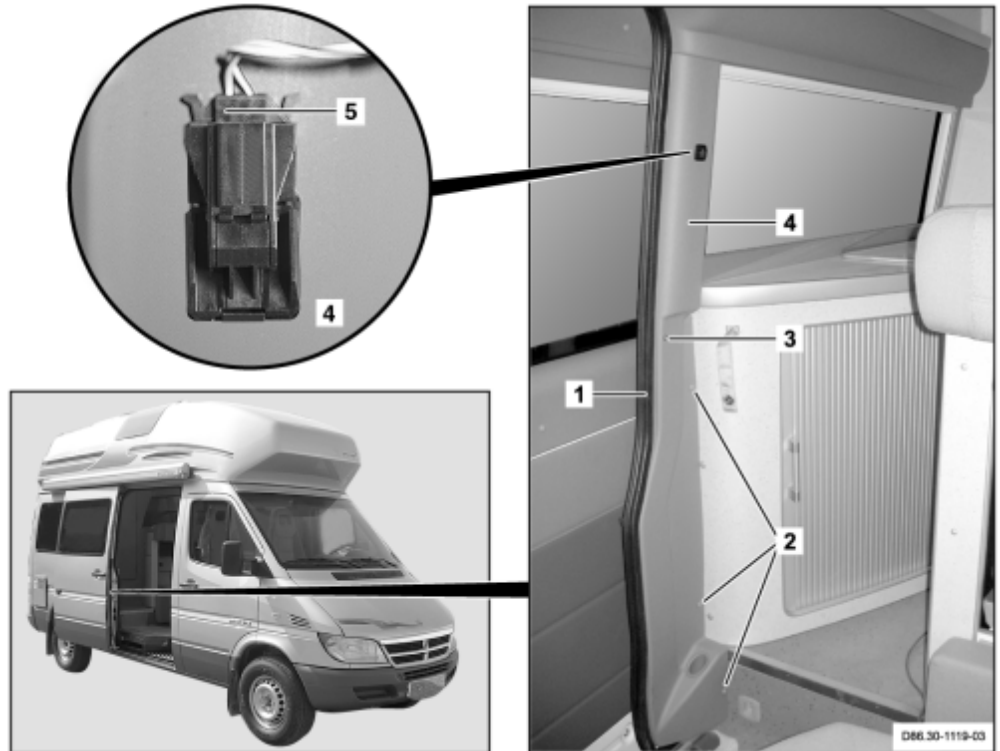

D68.30-1120-06

☒ ☒	Remove/Install	i See Operating Instructions
1	Remove umbrella	i See Operating Instructions
2	Remove rubber seal in area of C-pillar paneling (4)	
3	Remove caps from bolts (2)	
4	Remove bolts (2)	
5	Unscrew pushbutton counterpiece (3)	
6	Remove C-pillar paneling (4) upward	
7	Disconnect electrical connector (5)	
8	Install in the reverse order	

MODEL 903.662

with CODE (ZU8) Version for USA

with CODE (Z29) "James Cook" touring camper, NAFTA

On left center vent window

- 1 Fastening strip
- 2 Lower trim
- 3 Transistor lamp
- 4 Upper trim
- 5 Side trim
- 6 Bolts
- 7 Roller sun blind

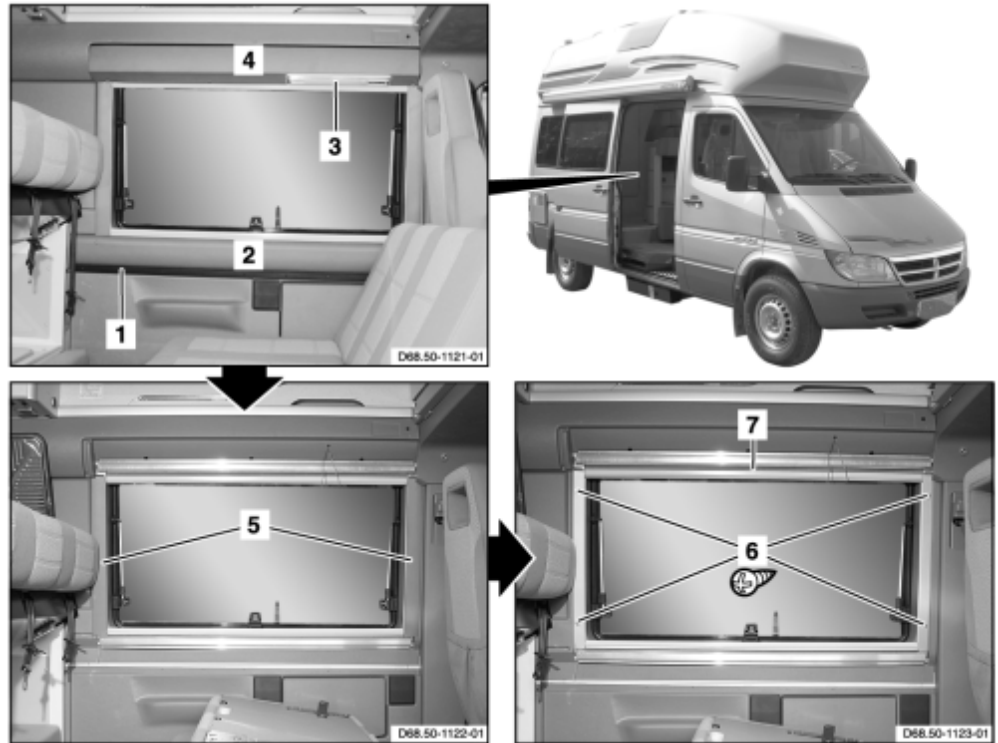

D68.50-1124-06

☒ ☒	Remove/Install	☒ Long wedge	☒ Installation: Note installation position. Avoid distorting sun shade, if necessary compensate by installing shims on bolt holes
1	Remove fastening strip (1) for table		AR86.60-D-0033A
2	Remove bottom trim (2) from left center vent window		AR68.30-D-1510A
3	Remove transistor lamp (3)		AR82.20-D-1015A
4	Remove upper trim (4) from left center vent window		AR68.30-D-1510B
5	Unclip side trim panel (5)	☒ Long wedge	115 589 03 59 00
6	Unscrew bolts (6)		
7	Remove roller sun blind (7)		

		(6)	
8	Install in the reverse order		



115 589 03 59 00

Long wedge

MODEL 903.662

with CODE (ZU8) National version for USA

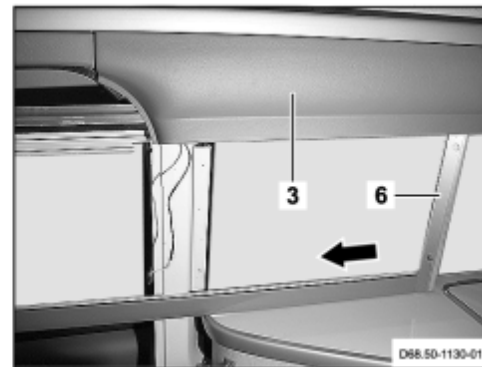
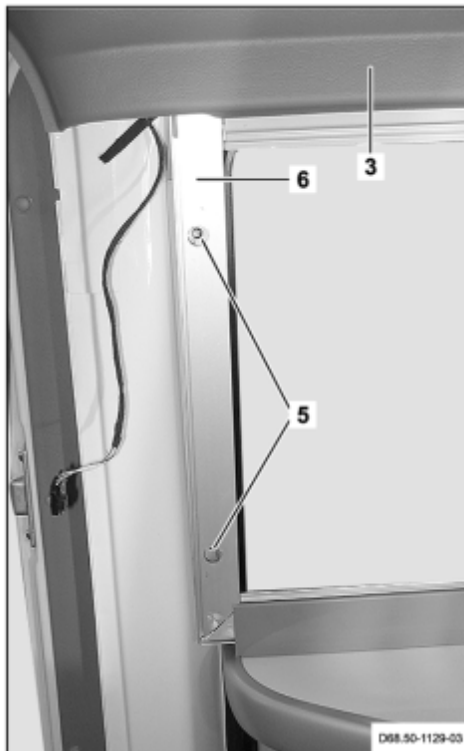
with CODE (Z29) "James Cook" touring camper, NAFTA
on right rear side window

D68.50-1131-09

1 Bolt
2 Upper paneling3 C-pillar paneling
4 Paneling5 Bolts
6 Roller sun blind

	Remove/Install		
1	Remove bolt cap (1)		
2	Remove bolt (1)		
3	Unclip upper paneling (2)	Mounting wedge	110 589 03 59 00
4	Remove C-pillar paneling (3)		AR68.30-D-4490A
5	Unclip paneling (4) from roller sun blind (6)	Mounting wedge	110 589 03 59 00
6	Unscrew bolts (5).	On left and right side of roller sun blind (6).	
7	Move roller sun blind (6) out toward front (arrow)	Installation: Note installation position. Avoid distorting roller	

		sun blind (6), if necessary shim bolt holes (5) for compensation	
8	Install in the reverse order		



110 589 03 59 00

Mounting wedge

MODEL 903.662

with CODE (ZU8) National version for USA

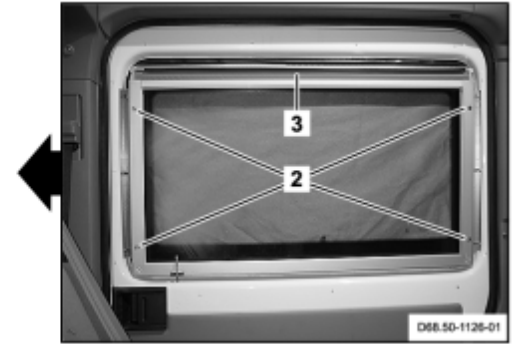

with CODE (Z29) "James Cook" touring camper, NAFTA
on right sliding door

D68.50-1127-07

1 Door panel

2 Bolts

3 Roller sun blind

	Remove/Install		
1	Remove door panel (1) from sliding door	Upper door panel	AR72.16-D-6610A
2	Remove bolts (2)		
3	Remove roller sun blind (3)	 Installation: Note installation position. Avoid distorting roller sun blind (3), if necessary shim bolt holes (2) for compensation	
4	Install in the reverse order		

MODEL 903.662

with CODE (ZU8) National version for USA

with CODE (Z29) "James Cook" touring camper, NAFTA

Side high roof vent window

- 1 Bolts
- 2 Bracket
- 3 Bolts
- 4 Roller sun blind

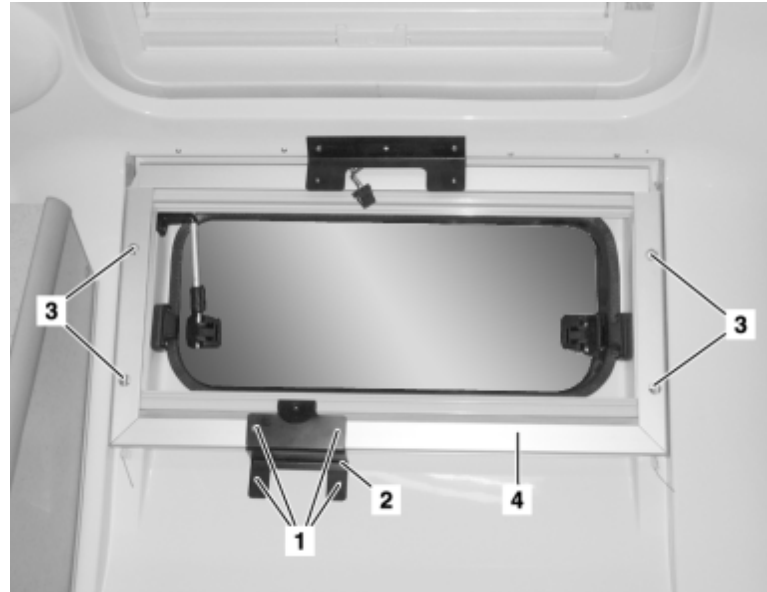

D68.50-1139-11

☒ ☒	Remove/Install		
⚠ Danger!	Risk of injury caused by scraping or cutting body parts on sharp vehicle parts	Always wear protective gloves when working on or near sharp and undeurred vehicle parts. Deburr replacement panels.	AS00.00-Z-0017-01B
1	Remove vent window paneling		AR68.30-D-1550A
2	Remove screws (1)		
3	Remove bracket (2)		
4	Remove bolts (3)		
5	Remove roller sun blind (4)		
6	Install in the reverse order		

MODEL 903.662

with CODE (ZU8) National version for USA

with CODE (Z29) "James Cook" touring camper, NAFTA

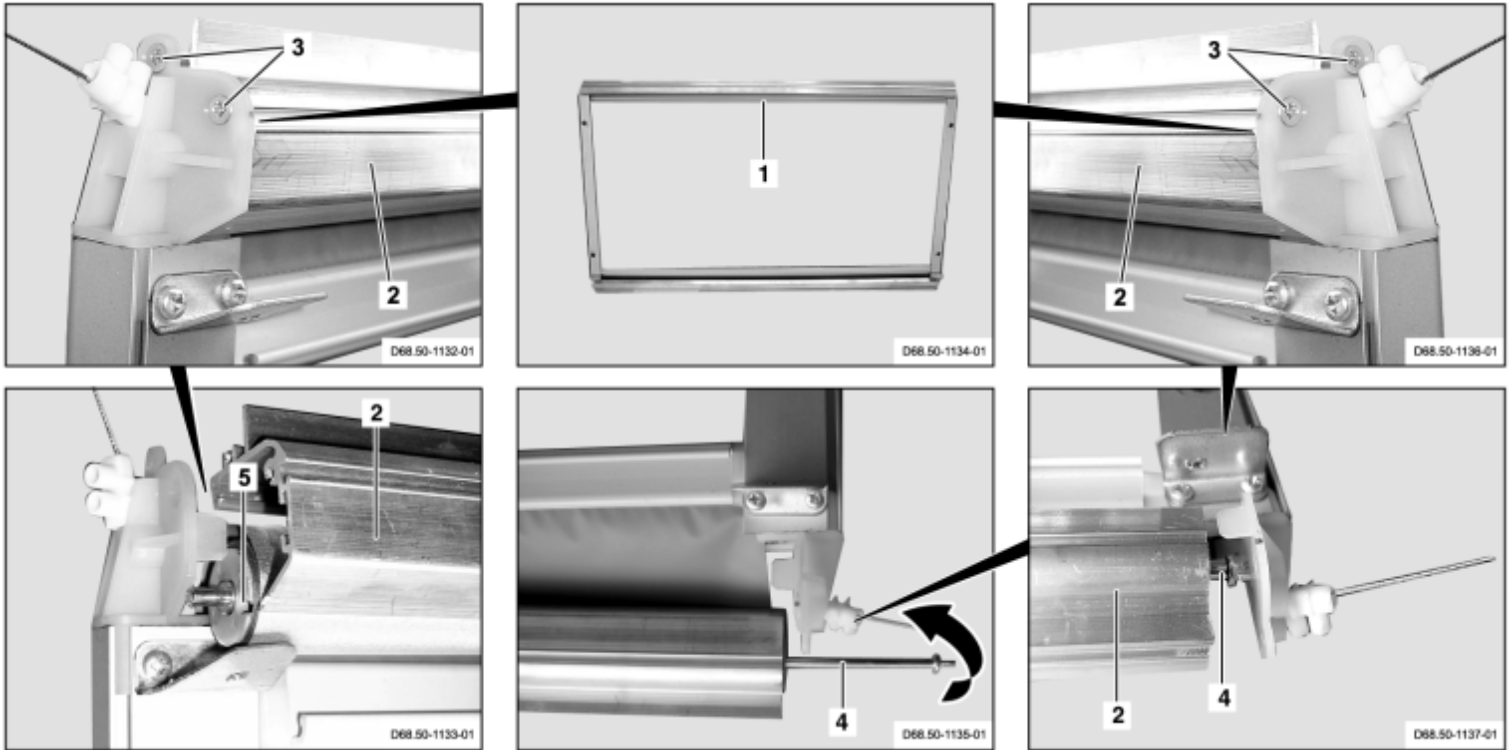

D68.50-1138-09

1 Roller blind
2 Roller blind cassette

3 Bolts
4 Pins

5 Opening

	Adjust		
1	Unscrew bolts (3) on left side of roller blind cassette (2)	i Remove roller blind (1) for entire adjustment work	
2	Slightly pull roller blind cassette (2) apart		
3	Spray a slight quantity of oil into the roller blind cassette (2) on left	i Into present opening (5). Use suitable oil	
4	Assemble roller blind cassette (2) on left		
5	Screw bolts (3) into roller blind cassette (2) on left		
6	Screw bolts (3) into roller blind cassette (2) on right		

7	Slightly pull roller blind cassette (2) apart on right		
8	Pull pin (4) out of roller blind cassette (2) on right	<input type="checkbox"/> Pull pin (4) 6 to 8 cm out of roller blind cassette (2) on right while releasing pin (4)	
9	Spray a slight quantity of oil in the roller blind cassette (2) on right	<input type="checkbox"/> Into present opening (5). Use suitable oil	
10	Tension pin (4) by turning to right	<input type="checkbox"/> Tension pin (4) 20 turns	
11	Install pin (4) in roller blind cassette (2) on right	<input type="checkbox"/> Thereby tension pin (4).	
12	Assembly roller blind cassette (2) on right	<input type="checkbox"/> Thereby tension pin (4).	
13	Screw bolts (3) into roller blind cassette (2) on right		
14	Perform a function test		
15.1	Readjust roller blind (1)	Only if the roller blind (1) is too easy or too hard to move in the guide	
		<input type="checkbox"/> Readjust by adjusting cable in insulating screw connector	

MODEL 903.662

with CODE (ZU8) National version for USA

with CODE (Z29) "James Cook" touring camper, NAFTA
in refrigerator box stowage cabinet

1 Valuables compartment



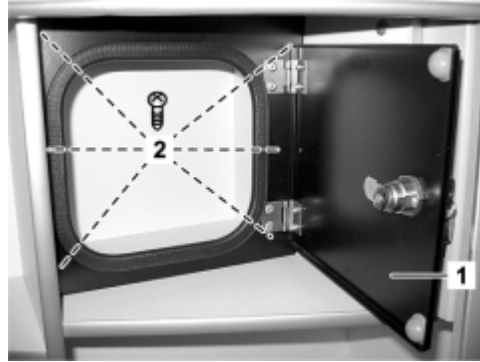

2 Bolts

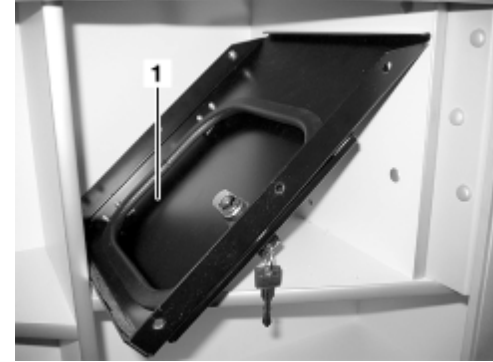

D68.72-0003-01



D68.72-0004-01

	Remove/Install		
 Danger!	Risk of injury caused by scraping or cutting body parts on sharp vehicle parts	Always wear protective gloves when working on or near sharp and undeurred vehicle parts. Deburr replacement panels.	AS00.00-Z-0017-01B
1	Open valuables compartment (1)		
2	Unscrew bolts (2)		
3	Remove valuables compartment (1)	 When removing valuables compartment (1) in lateral position on stowage cabinet	
		 Installation: When installing valuables compartment (1) in lateral position in stowage cabinet	
4	Install in the reverse order		

MODEL 903.662

with CODE (ZU8) National version for USA

with CODE (Z29) "James Cook" touring camper, NAFTA
in refrigerator box stowage cabinet



1 Valuables compartment

2 Nut

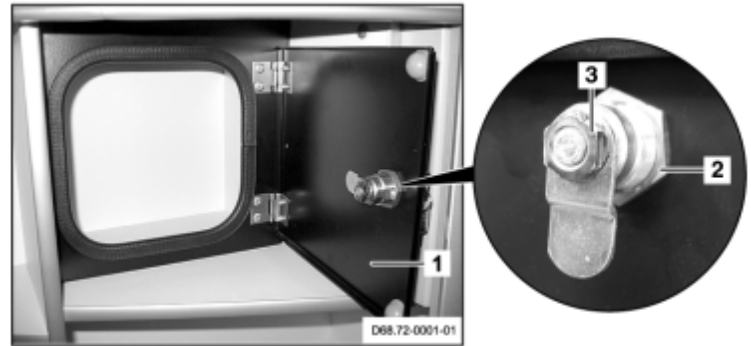
3 Lock



D68.72-0002-10

 	Remove/Install		
1	Open valuables compartment (1)		
2	Unscrew nut (2)		
3	Remove lock (3)	 Installation: Observe installation position of lock (3)	
4	Install in the reverse order		

MODEL 903.662

with CODE (ZU8) National version for USA

with CODE (Z29) "James Cook" touring camper, NAFTA

Upper door panel

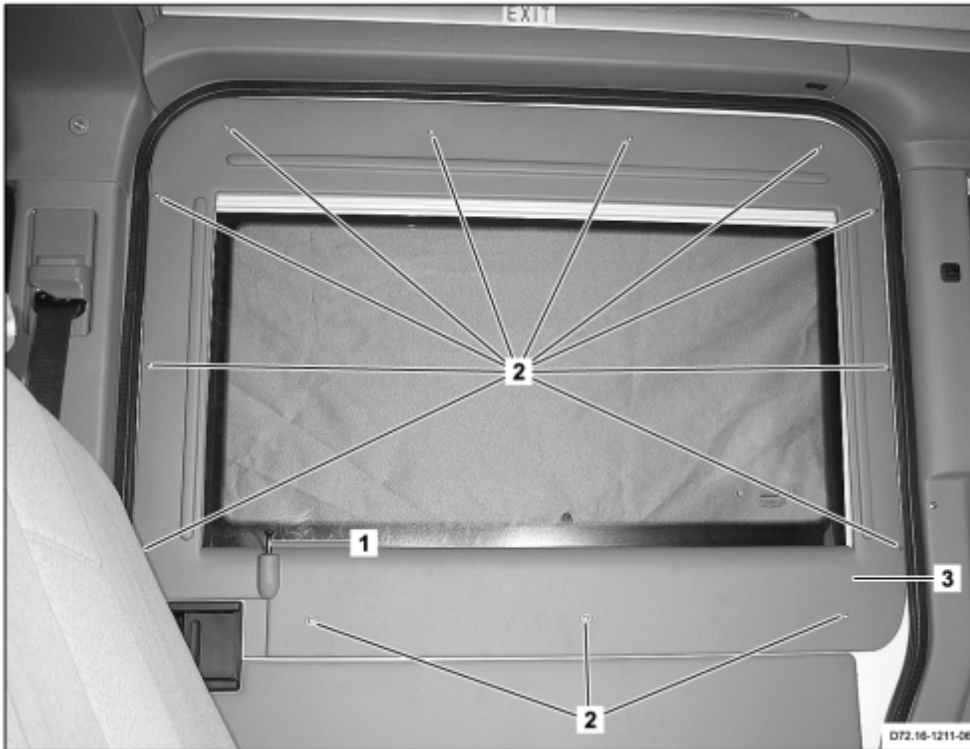





D72.16-1212-09

1 Locking knob

2 Screws

3 Door panel

 	Remove/Install		
1	Unscrew locking knob (1)	 Self-locking thread. Locking knob (1) cannot be removed without damage.	
2	Remove caps from screws (2)		
3	Remove screws (2)		
4	Remove door panel (3)	 Mounting wedge	110 589 03 59 00
5	Install in the reverse order		



110 589 03 59 00

Mounting wedge

MODEL 903.662

with CODE (ZU8) National version for USA

with CODE (Z29) "James Cook" touring camper, NAFTA

1 Screws

2 Rear-end door stowage
compartment

D72.20-1177-04

	Remove/Install		
1	Open rear-end door		
2	Remove caps from screws (1)		
3	Remove screws (1)		
4	Remove rear-end door stowage compartment (2)		
5	Install in the reverse order		

MODEL 903.662

with CODE (ZU8) National version for USA

with CODE (Z29) "James Cook" touring camper, NAFTA

with CODE (W54) Double rear door opening 270 degrees

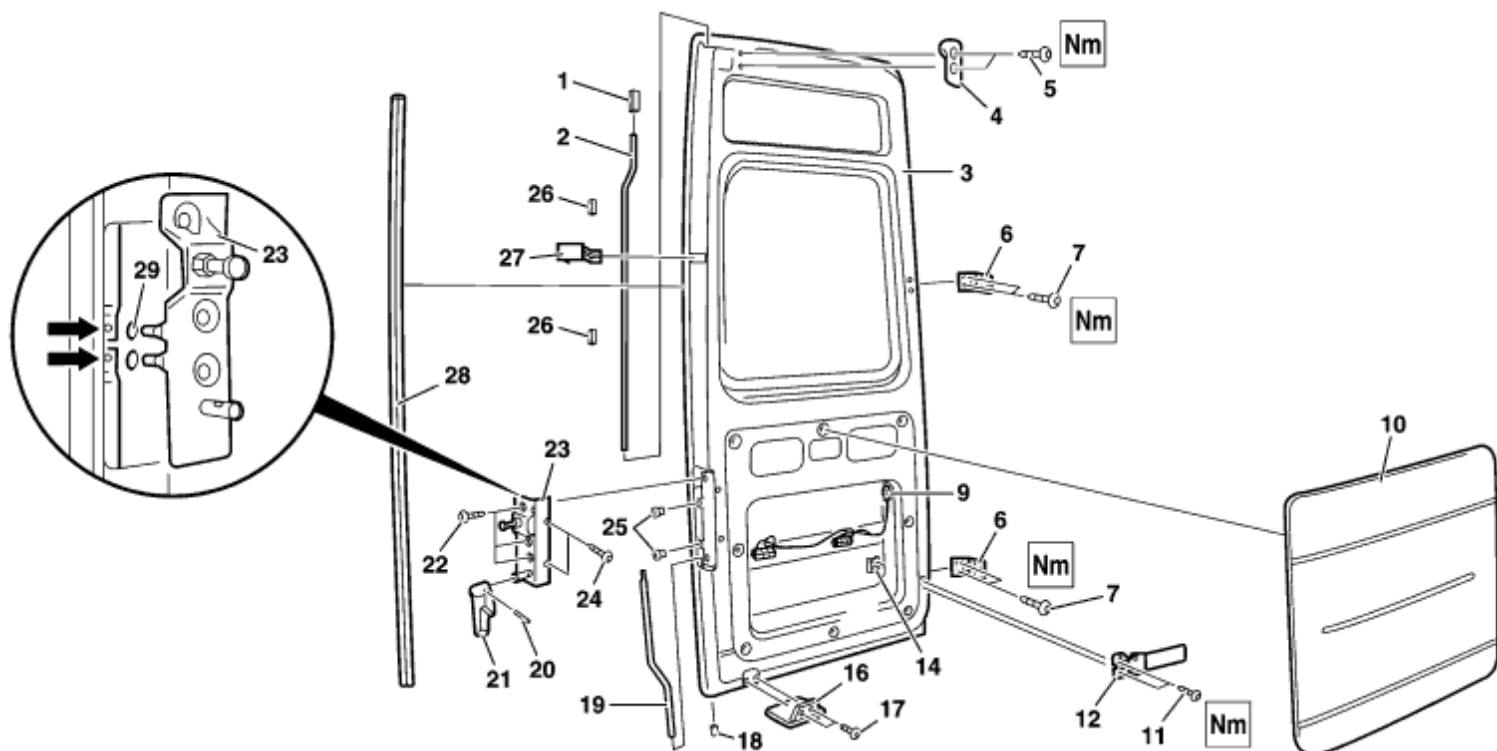

D72.20-1184-09

1 Lock rod guide

2 Upper lock rod

3 Rear-end door

4 Upper closing wedge

5 Bolts

6 Hinges

7 Bolts

9 Electrical connector

10 Door paneling

8 Rear-end door stowage
compartment

13 Model plate

15 Covering

E75 License plate illumination

E76 License plate illumination

S116 Rear-end door contact
switch

11 Bolts

12 Door catch

14 Tapping plate

16 Lower closing wedge

17 Rivets

18 Lock rod guide

19 Lower lock rod

20 Roll pin

21 Lock pin handle

22 Bolts

23 Rod-type lock

24 Bolts

25 Clips

26 Felt strip

27 Lock rod guide

28 Rear-end door seal

29 O-ring

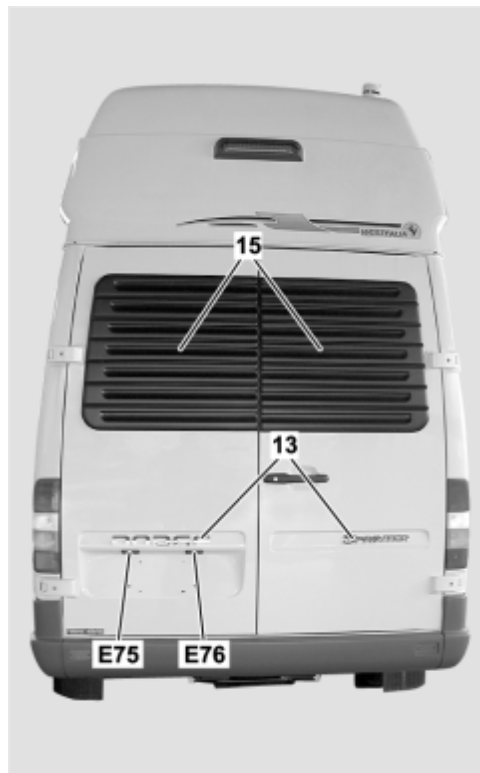









D72.20-1185-03



D72.20-1186-03

	Disassemble/assemble		
⚠ Danger!	Risk of injury caused by scraping or cutting body parts on sharp vehicle parts	Always wear protective gloves when working on or near sharp and undeurred vehicle parts. Deburr replacement panels.	AS00.00-Z-0017-01B
⚠ Danger!	Injury hazard by pinching or cutting off extremities with doors, covers, flaps and loose components	Keep limbs away from motion area when moving doors, covers, flaps and components. Wear protective gloves	AS00.00-Z-0025-01A
1	Remove rear-end door shelf (8)		AR72.20-D-1050A
2	Remove door panel (10) from rear-end door (3)		
3	Disconnect electrical connector (9)		
4	Remove license plate illumination (E75, E76)		AR82.10-D-5161A
5	Remove rear-end door contact switch (S116)		
6	Drive out roll pin (20)	i Installation: Replace roll pin (20).	
7	Remove lock rod handle (21)		
8	Remove door catch (12)	i Installation: Observe	AR72.20-D-2411-

		installation position of tapping plate (14). Check adjustment of door catch (12) to counter element on D-pillar	01B
		 Screw, door catch to rear-end door	BA72.20-N-1003-01A
9	Unscrew bolts (11)	 Screw, door hinge to rear-end door	BA72.20-N-1004-01A
10	Remove door hinges (6)	 T40 socket wrench bit, 70 mm shank length	WH58.30-Z-1028-06A
11	Unscrew bolts (5)	 Screw, top closing wedge to rear-end door	BA72.20-N-1002-01A
12	Remove top closing wedge (4)		
13	Drill out rivets (17)	 Drill with dia. 4.8 mm bit	
		Drill (electric/pneumatic)	WE58.40-Z-1001-03A
14	Remove lower closing wedge (16)		
15	Remove rear-end door seal (28) from rear-end door (3)	 Installation: Check rear-end door seal (28) for proper state, replace if necessary.	
		 Installation: Position rear-end door seal (28) first at top and bottom flush on rear-end door (3) and then push from outside toward inside.	
16	Unscrew bolts (22)		
17	Unscrew bolts (24)		
18	Fasten upper lock rod (2) on rear-end door (3) against falling down with suitable tool.		
19	Remove lock rod (23)	 Installation: The bolts of the lock rod (23) must engage in the holes (arrows)	
		 Installation: One dia. 6 mm rubber ring each can be pulled over the bolts on the lock rod (23) to prevent rattling.	
20	Remove clips (25)		
21	Remove lock rod guides (1, 18,		

	27)		
22	Remove upper lock rod (2) and lower lock rod (19) together from rear-end door (3)		
23.1	Remove cover (15)	Cover for rear-end door window	AR88.00-D-1360AB
		Only when old rear-end door (3) is reused	
		i The covering (15) cannot be removed without damage.	
24.1	Remove model plate (13) from rear-end door (3)	Only when old rear-end door (3) is reused	
		i The model plate (13) cannot be removed without damage	
		i Installation: To install the new model plate (13) on tailgate, see: ↓	
		Install model plate (13) on tailgate	AR72.20-D-3660A
25	Assemble in reverse order		

Nm Rear-end door

Number	Designation	Model 690.6, 901, 902, 903, 904
BA72.20-N-1002-01A	Screw, top closing wedge to rear-end door	Nm 10
BA72.20-N-1003-01A	Screw, door catch to rear-end door	Nm 10
BA72.20-N-1004-01A	Screw, door hinge to rear-end door	Nm 25

Commercially available tools (see Workshop Equipment Manual)

Number	Designation	Make (e. g.)	Order number
WH58.30-Z-1028-06A	T40 socket wrench bit, 70 mm shank length	Eduard Wille Lindenallee 27 D-42349 Wuppertal- Cronenberg	1054

Workshop equipment/MB testers (see Workshop Equipment Manual)

WE58.40-Z-1001-03A	Drill (electric/pneumatic)
--------------------	----------------------------

MODEL 903.662

with CODE (ZU8) National version for USA

with CODE (Z29) "James Cook" touring camper, NAFTA

with CODE (W54) Double rear-end door opening 270 degrees

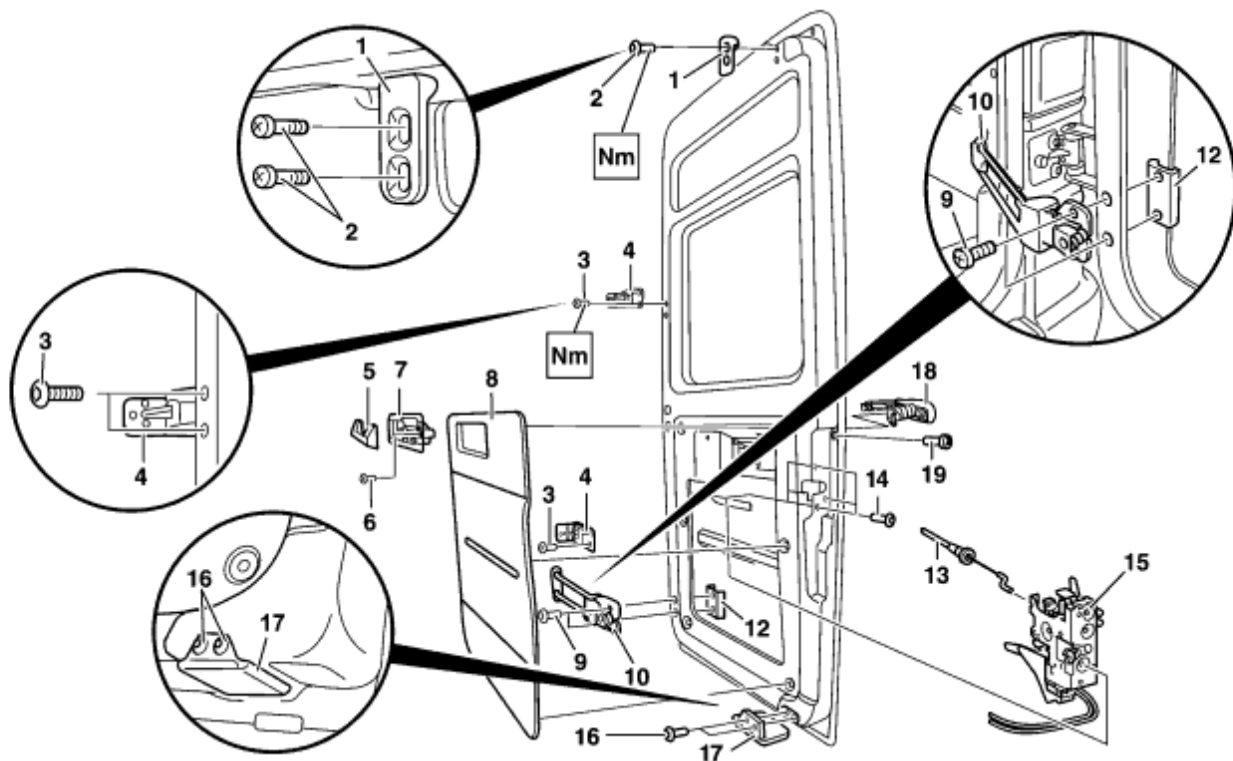

D72.20-1181-09

1 Upper closing wedge

2 Bolts

3 Bolts

4 Door hinges

5 Inside door opener covering

6 Screw

7 Inside door opener

8 Door panel

9 Bolts

10 Door catch

12 Tapping plate

13 Release cable

14 Bolts

15 Door lock

16 Rivets

17 Lower closing wedge

18 Outer door handle

19 Screw

20 Rear-end door stowage
compartment

21 Covering

22 Model plate

E75 License plate illumination

E76 License plate illumination



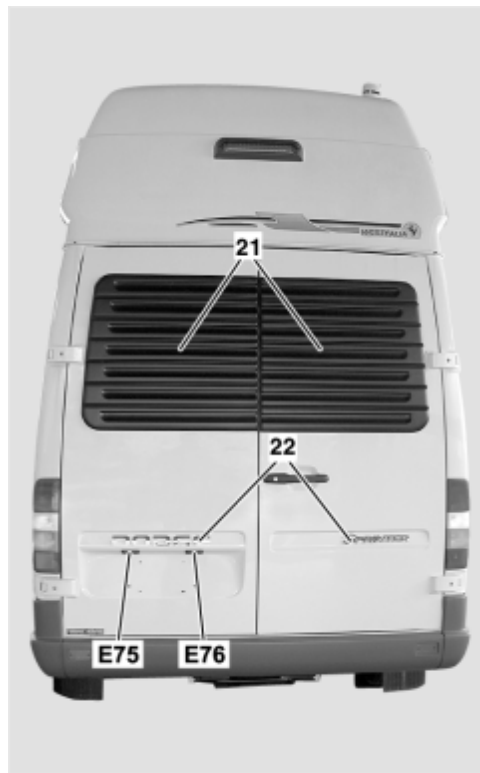

S116 Rear-end door contact
switch

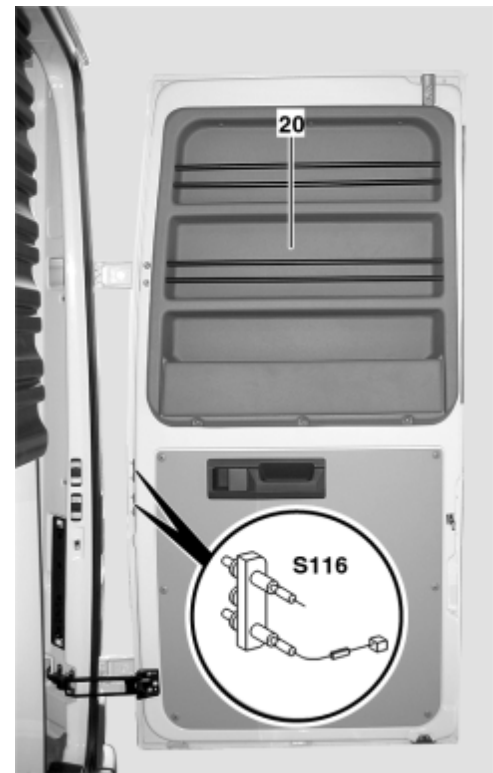









D72.20-1182-03



D72.20-1183-03

	Disassemble/assemble		
⚠ Danger!	Risk of injury caused by scraping or cutting body parts on sharp vehicle parts	Always wear protective gloves when working on or near sharp and undeurred vehicle parts. Deburr replacement panels.	AS00.00-Z-0017-01B
⚠ Danger!	Injury hazard by pinching or cutting off extremities with doors, covers, flaps and loose components	Keep limbs away from motion area when moving doors, covers, flaps and components. Wear protective gloves	AS00.00-Z-0025-01A
1	Remove inside door opener (7)		AR72.20-D-4075A
2	Remove door paneling (8) from rear door		
3	Remove door lock (15).		AR72.20-D-4055A
4	Unscrew bolt (19) from outer door handle (18)	 Screw, door handle on rear-end door	BA72.20-N-1007-01A
5	Slide outer door handle (18) to right and remove	 Installation: Insert outer door handle (18) and slide to left until the catches arrest on the inside	
6	Drill out rivets (16)	 Drill with dia. 4.8 mm bit	
		Drill (electric/pneumatic)	WE58.40-Z-1001-03A

7	Remove bottom closing wedge (17)		
8	Unscrew bolts (2)	 Screw, top closing wedge to rear-end door	BA72.20-N-1002-01A
9	Remove top closing wedge (1)		
10	Remove door catch (10).	 Installation: Observe installation position of tapping plate (12). Check adjustment of door catch (10) to counter element on D-pillar	AR72.20-D-2411-01B
		 Screw, door catch to rear-end door	BA72.20-N-1003-01A
11	Remove screws (3)	 Screw, door hinge to rear-end door	BA72.20-N-1004-01A
		 T40 socket wrench bit, 70 mm shank length	WH58.30-Z-1028-06A
12	Remove door hinges (4)		
13	Remove rear-end door contact switch (S116)	 Remove both rear-end door contact switches (S116).	
14	Remove rear-end door shelf (20)		AR72.20-D-1050A
15.1	Remove covering (21)	Cover for rear-end door window	AR88.00-D-1360AB
		Only when old rear-end door is reused	
		 The covering (21) cannot be removed without damage	
16.1	Remove model plate (22) from rear-end door	Only when old rear-end door is reused	
		 The model plate (22) cannot be removed without damage	
		 Installation: To install the new model plate (22) on the tailgate, see: ↓	
		Install model plate (22) on tailgate	AR72.20-D-3660A
17	Assemble in reverse order		

 **Rear-end door**

--	--	--

Number	Designation	Model 690.6, 901, 902, 903, 904
BA72.20-N-1002-01A	Screw, top closing wedge to rear-end door	Nm 10
BA72.20-N-1003-01A	Screw, door catch to rear-end door	Nm 10
BA72.20-N-1004-01A	Screw, door hinge to rear door	Nm 25
BA72.20-N-1007-01A	Screw, door handle to rear-end door	Nm 10

Commercially available tools (see Workshop Equipment Manual)

Number	Designation	Make (e. g.)	Order number
WH58.30-Z-1028-06A	T40 socket wrench bit, 70 mm shank length	Eduard Wille Lindenallee 27 D-42349 Wuppertal- Cronenberg	1054

Workshop equipment/MB testers (see Workshop Equipment Manual)

WE58.40-Z-1001-03A	Drill (electric/pneumatic)
--------------------	----------------------------

MODEL 903.6

with CODE (ZU8) National version for USA

with CODE (Z29) "James Cook" touring camper, NAFTA

1 Model plate

2 Adhesive tape

3 Carrier foil

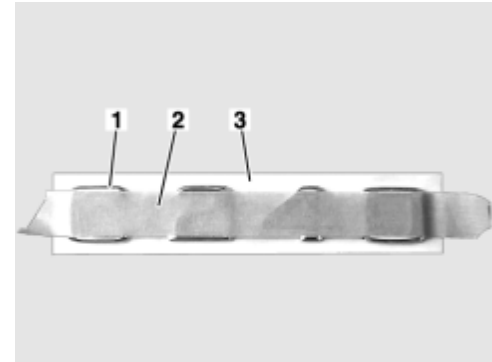

P88.50-2116-01

1 Model plate

4 Assembly template



D72.20-1180-10

☑	Check		
1	Check position of model plate (1) on carrier foil (3)	☑ Correct if necessary.	
2	Mask model plate (1) with adhesive tape (2)		
☑	Cleaning		
3	Clean tailgate in area of model plate (1)		
4	Heat tailgate in area of model plate (1)	☑ With radiant heater to approx. 30 ° C.	
5	Install assembly template (4) on tailgate	☑ Align assembly template (4) on contours of tailgate.	
		☑ Assembly template (4) is delivered together with new part	

6	Remove carrier foil (3) from model plate (1)	i Model plates (1) should remain fastened on the adhesive tape (2)	
7	Align model plate (1) on assembly template (4) and press on		
8	Remove adhesive tape (2)		

MODEL 903.662

with CODE (ZU8) Version for USA

with CODE (Z29) "James Cook" touring camper, NAFTA

- 1 Bolts
- 2 Top locking rod*
- 3 Bolts
- 4 Lock
- 5 Bolts
- 6 Bolts
- 7 Bottom locking rod*



D72.40-0003-06

	Remove/Install		
1	Remove door knob from wet cell door*		AR72.40-D-4803A
2	Remove bolts (1)		
3	Remove top locking rod (2) in direction of arrow*		
4	Remove bolts (3)		
5	Remove lock (4) upward*		
6	Unscrew bolts (5)		
7	Remove bolts (6)		
8	Remove bottom locking rod (7) *		
9	Install in the reverse order		
10	Check door locking system for proper function*		

MODEL 903.662

with CODE (ZU8) Version for USA

with CODE (Z29) "James Cook" touring camper, NAFTA

1 Bolt
2 Door knob*

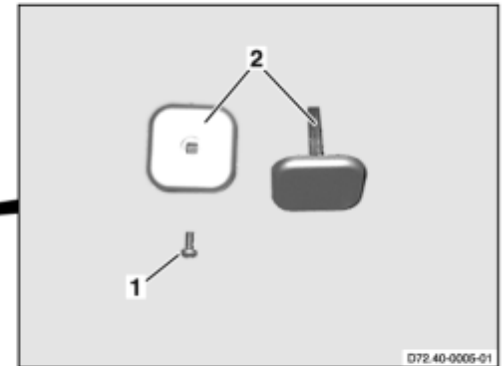

D72.40-0006-06

☒ ☒	Remove/Install		
1	Remove bolt (1)	i Installation: Screw in bolt (1) hand-tight.*	
2	Remove door knob (2)*		
3	Install in the reverse order		
4	Check door knob (2) for proper function*		

MODEL 903.662

with CODE (ZU8) National version for USA

with CODE (Z29) "James Cook" touring camper, NAFTA

with CODE (DL1) Electric lifting/tilting roof window, James Cook

1 Covers

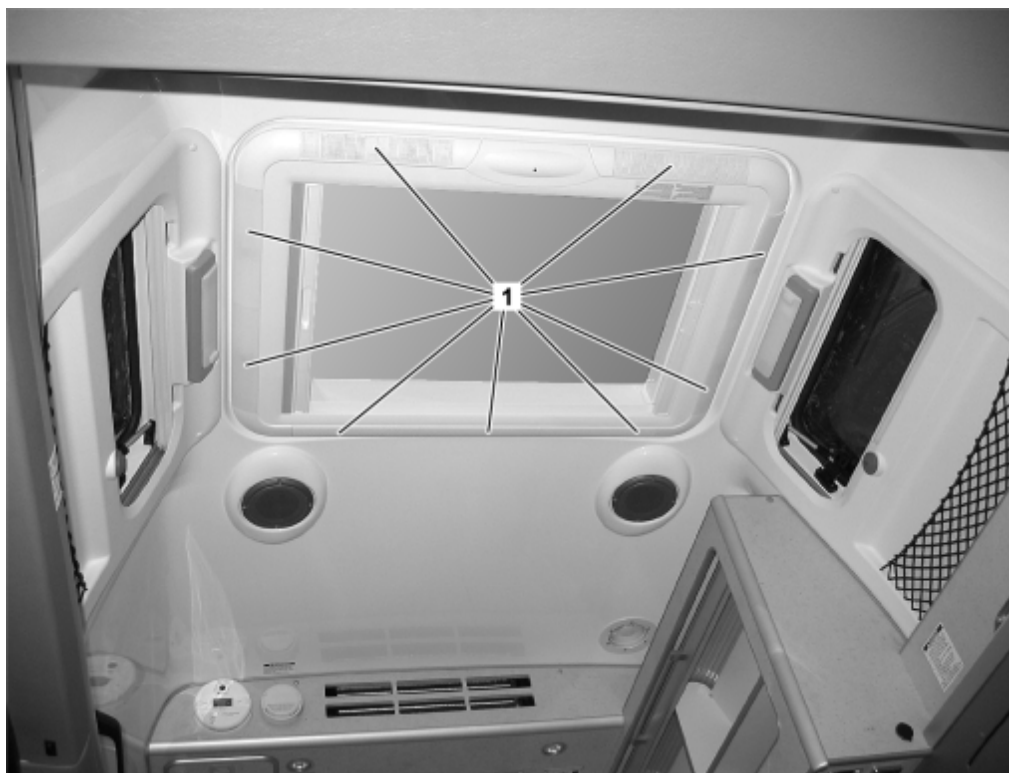

D77.55-0010-06

2 Plug

3 Bolts

4 Inner frame for lifting/tilting roof window

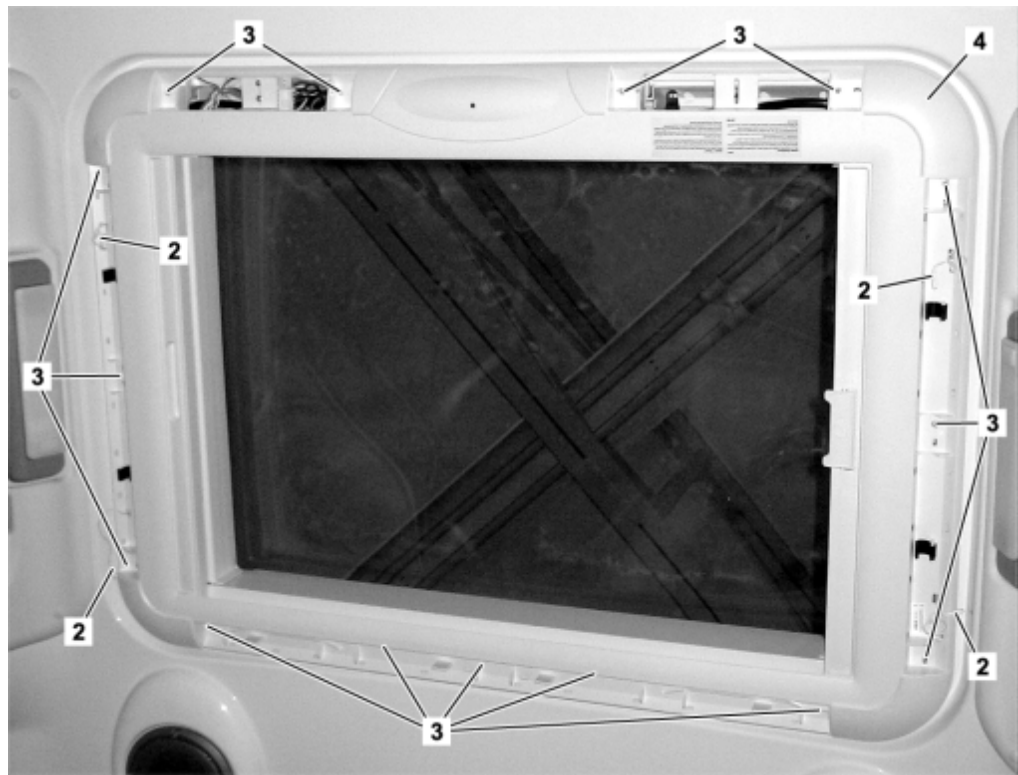

D77.55-0011-06

- 5 Nuts
- 6 Printed circuit board
- 7 Connector
- 8 Bolts
- 9 Screw connector
- 10 Electrical lines

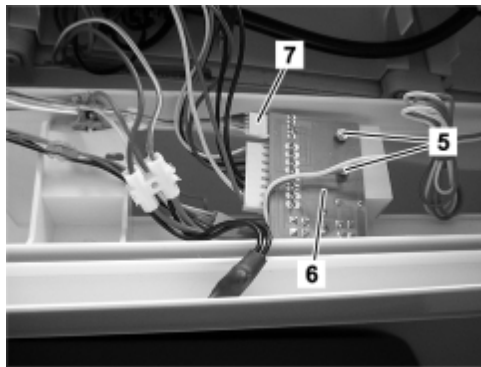

D77.55-0013-01

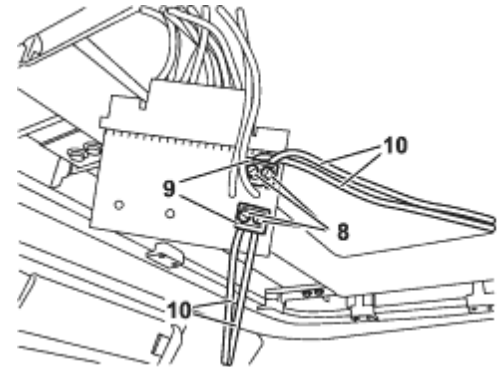

D77.55-0014-01

- 11 Bolts
- 12 Assembly stands
- 13 Outer frame for lifting/tilting roof window

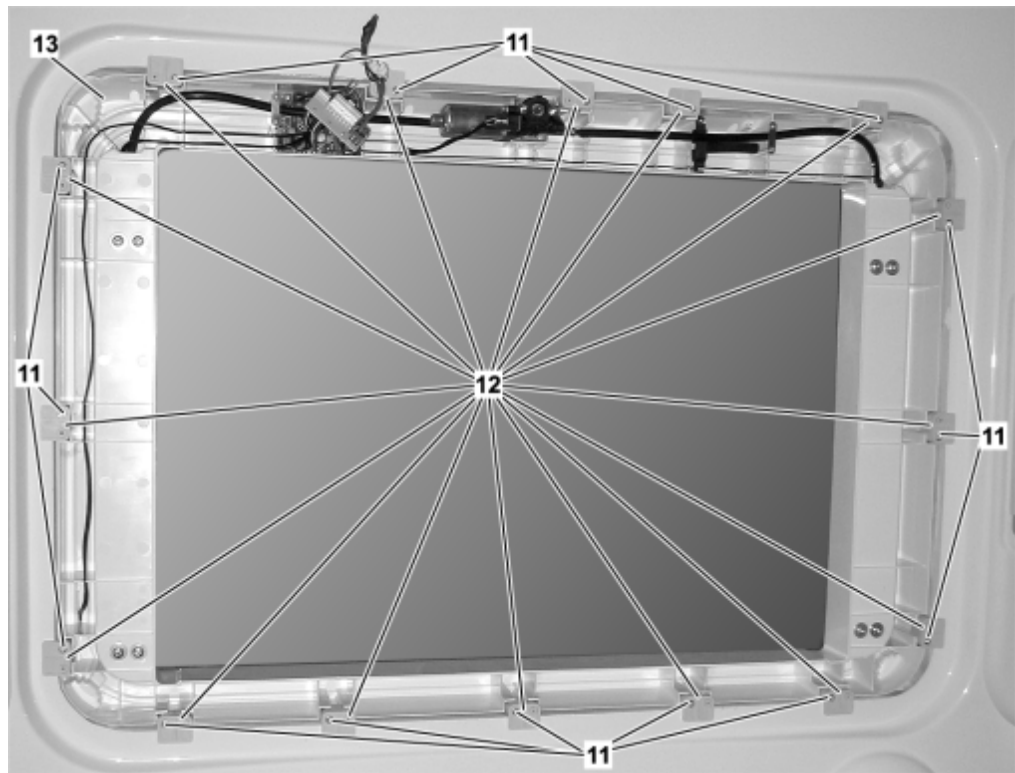

D77.55-0015-06

☒ ☒	Remove/Install		
⚠ Danger!	Risk of injury caused by body parts becoming jammed, pinched or severed by doors, covers, flaps or by loose components	Keep body parts well clear when moving doors, covers, flaps and components. Wear protective gloves and protective shoes.	AS00.00-Z-0025-01A
⚠ Danger!	Risk of death caused by falling down from the roof of the vehicle. Risk of injury to other persons caused by falling objects during work in the area of the roof.	Work on or in the area of the vehicle's roof may only be performed on suitable equipment (ladders, scaffolds, lifting platforms). Sufficiently secure the area to be worked in.	AS65.00-Z-0002-01B
1	Unclip covers (1) and remove	☒ Mounting wedge	110 589 03 59 00
2	Remove plug (2) from fluorescent lamps		
3	Remove fluorescent lamps		
4	Remove bolts (3)		
5	Fold down inner frame for lifting/tilting roof window (4)		
6	Detach connector (7)		
7	Unscrew nut (5) from printed circuit board (6)		
8	Remove printed circuit board (6)		

9	Unscrew screws (8) from screw connectors (9)	i Note installation position of electrical lines (10).	
10	Pull electrical lines (10) out of screw connectors (9)		
11	Remove lifting/tilting roof window inner frame (4)		
12	Unscrew screws (11) from assembly stands (12)		
13	Remove assembly stands (12)		
14	Remove outer frame for lifting/tilting roof window (13) from outside	i Helper required	
15	Install in the reverse order		
16	Perform a function test		
17	Carry out leak checks		



110 589 03 59 00

Mounting wedge

MODEL 903.662

with CODE (ZU8) National version for USA

with CODE (Z29) "James Cook" touring camper, NAFTA

Sanitary block

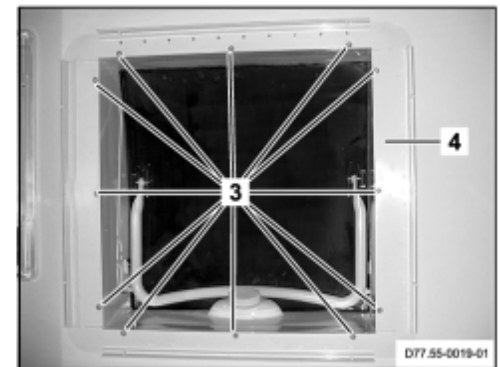
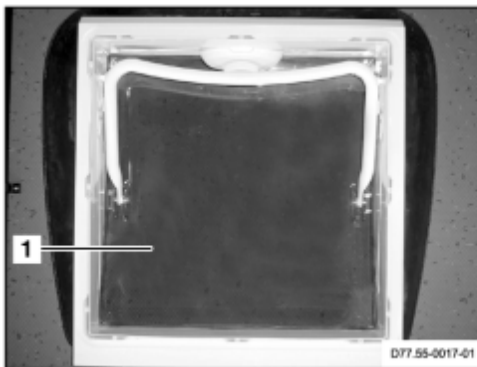
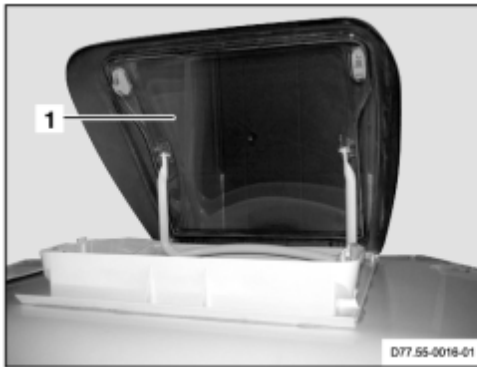

D77.55-0020-09





1 Lifting/tilting roof window

3 Bolts

4 Frame bottom section

2 Blackout blind

	Remove		
Danger!	Injury hazard by pinching or cutting off extremities with doors, covers, flaps and loose components	Keep limbs away from motion area when moving doors, covers, flaps and components. Wear protective gloves	AS00.00-Z-0025-01A
Danger!	Risk of death caused by falling from vehicle roof. Risk of injury to other persons caused by falling objects during work in roof area.	Perform work on and in area of vehicle roof only with suitable aids (ladders, scaffolding, assembly platforms). Sufficiently secure working area	AS65.00-Z-0002-01B
1	Remove blackout blind (2) from lifting/tilting roof window (1) in sanitary block		AR77.55-D-5010B
2	Remove bolts (3)		

3	Remove frame bottom section (4)		
4	Open lifting/tilting roof window (1)		
5	Loosen lifting/tilting roof window (1) from high roof	 Mounting wedge	110 589 03 59 00
6	Remove lifting/tilting roof window (1)		
	Install		
7	Remove glue residues from high roof	 Sealing surface must be free of dust, oil, grease, wax, dirt residues and other adhesive components	
		Sikaflex adhesive cleaner 205	BR00.45-Z-1050-04A
8.1	Remove glue residues from lifting/tilting roof window (1)	 Only when old lifting/tilting roof window (1) is reused.	
		 Sealing surface must be free of dust, oil, grease, wax, dirt residues and other adhesive components	
		Sikaflex adhesive cleaner 205	BR00.45-Z-1050-04A
9	Install new sealing tape on lifting/tilting roof window (1)	dia. 6 mm butyl cord	BR00.45-Z-1068-01A
10	Insert lifting/tilting roof window (1) into high roof and press on firmly		
11	Install frame bottom section (4)		
12	Screw in screws (3).		
13	Install blackout blind (2) on lifting/tilting roof window (1) in sanitary block		AR77.55-D-5010B
14	Carry out leak checks		



110 589 03 59 00

Mounting wedge

Auxiliary repair materials

Number	Designation	Order number
BR00.45-Z-1068-01A	Butyl cord, dia. 6 mm	001 987 73 46 10
BR00.45-Z-1050-04A	Sikaflex bonding cleaner 205	Sika Chemie GmbH Stuttgarter Straße 139 D-72574 Bad Urach

MODEL 903.662

with CODE (ZU8) National version for USA

with CODE (Z29) "James Cook" touring camper, NAFTA

Sanitary block

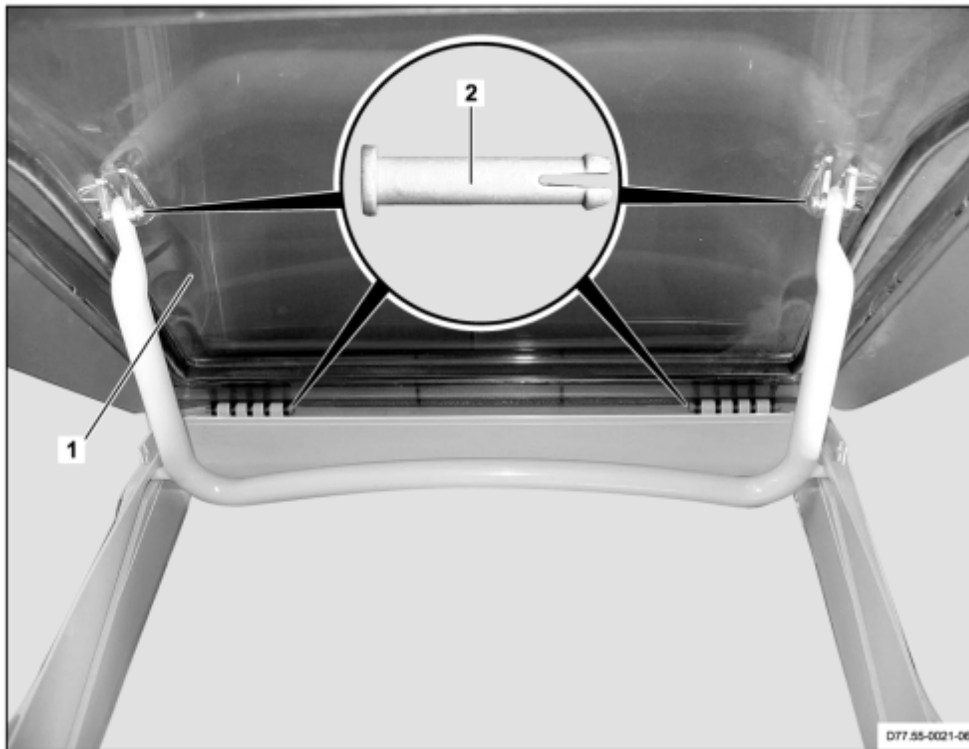

D77.55-0022-09

1 Glass lifting/tilting roof window

2 Pin

☒ ☒	Remove/Install		
⚠ Danger!	Injury hazard by pinching or cutting off extremities with doors, covers, flaps and loose components	Keep limbs away from motion area when moving doors, covers, flaps and components. Wear protective gloves	AS00.00-Z-0025-01A
⚠ Danger!	Risk of death caused by falling from vehicle roof. Risk of injury to other persons caused by falling objects during work in roof area.	Perform work on and in area of vehicle roof only with suitable aids (ladders, scaffolding, assembly platforms). Sufficiently secure working area	AS65.00-Z-0002-01B
1	Open lifting/tilting roof window		
2	Remove bolt (2)		
3	Remove lifting/tilting roof window glass (1)		

4	Install in the reverse order		
5	Carry out leak checks		

MODEL 903.662

with CODE (ZU8) National version for USA

with CODE (Z29) "James Cook" touring camper, NAFTA



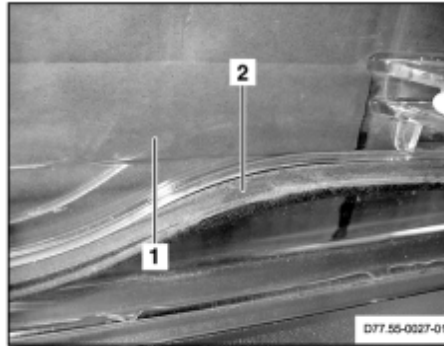

Sanitary block

1 Glass lifting/tilting roof window

2 Sealing profile



D77.55-0028-04

	Remove		
1	Remove lifting/tilting roof window glass (1) in sanitary block		AR77.55-D-5005B
2	Lightly heat sealing profile (2)	 Heat only with low temperature, otherwise the lifting/tilting roof window glass (1) can be damaged by overheating.	
		Heat gun	WE58.40-Z-1007-03A
3	Remove sealing profile residues (2) from lifting/tilting roof window glass (1)	 Gluing surface on lifting/tilting roof window glass (1) should be free of dust, oil, grease, wax, dirt residues and other adhesive components	
		Sikaflex adhesive cleaner 205	BR00.45-Z-1050-04A
	Install		
4	Install new sealing profile (2) on lifting/tilting roof window glass (1)	 The ends of the sealing channel (2) should point toward rear of the vehicle to prevent leakage.	
5	Install lifting/tilting roof window glass (1) in sanitary block		AR77.55-D-5005B
6	Carry out leak checks		

Workshop equipment/MB testers (see Workshop Equipment Manual)

WE58.40-Z-1007-03A	Heat gun
--------------------	----------

Auxiliary repair materials

Number	Designation	Order number
BR00.45-Z-1050-04A	Sikaflex bonding cleaner 205	Sika Chemie GmbH Stuttgarter Straße 139 D-72574 Bad Urach

MODEL 903.662

with CODE (ZU8) National version for USA

with CODE (Z29) "James Cook" touring camper, NAFTA

Sanitary block

1 Lifting/tilting roof window

2 Lock

3 Stop

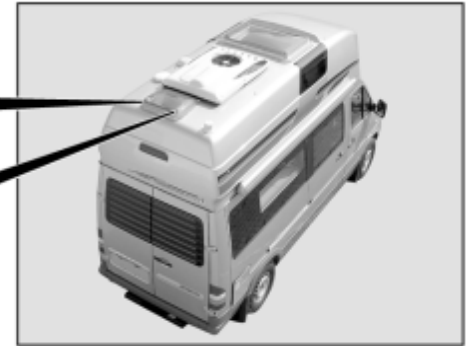
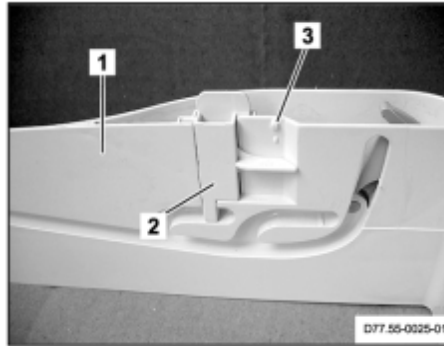

D77.55-0026-04

	Remove/Install		
Danger!	Injury hazard by pinching or cutting off extremities with doors, covers, flaps and loose components	Keep limbs away from motion area when moving doors, covers, flaps and components. Wear protective gloves	AS00.00-Z-0025-01A
1	Open lifting/tilting roof window (1) in sanitary block	See Operating Instructions	
2	Press lock (2) upward	Slightly pull lock (2) away from stop (3)	
3	Install in the reverse order		

MODEL 903.662

with CODE (ZU8) National version for USA

with CODE (Z29) "James Cook" touring camper, NAFTA

Sanitary block

1 Retractable cover



2 Lifting/tilting roof window



D77.55-0023-01



D77.55-0024-01

 	Remove/Install		
1	Unclip retractable cover (1) from lifting/tilting roof window (2) in sanitary block	 Mounting wedge	110.589.03.59.00
2	Install in the reverse order		



110 589 03 59 00

Mounting wedge

MODEL 903.662

with CODE (ZU8) National version for USA

with CODE (Z29) "James Cook" touring camper, NAFTA

with CODE (DL1) Electric lifting/tilting roof window, James Cook

1 Inner frame

2 Covering

3 Fly protection screen

4 Guides

5 Handle

6 Guide rails

7 Pins

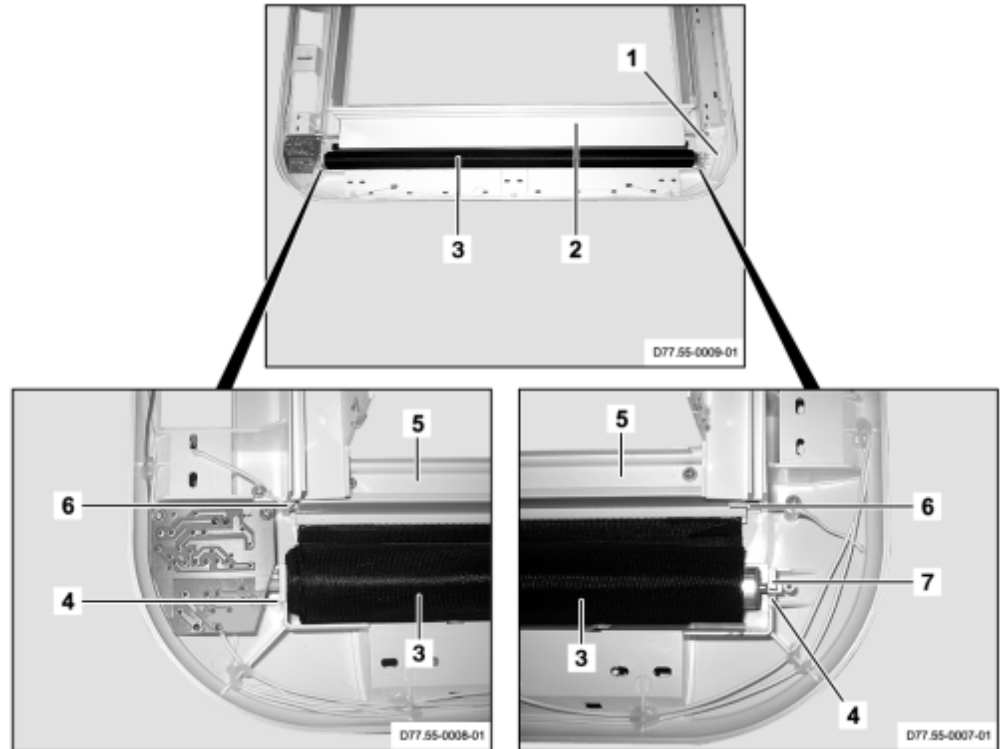

D77.55-0006-06

☒ ☒	Remove/Install	i	Installation: Pretension spring mechanism by turning pin (7) approx. 20 turns with battery-powered screwdriver Fasten entire pin (7) with pliers
1	Remove inner frame (1) from lifting/tilting roof window		AR77.55-D-5000A
2	Remove cover (2)		
3	Unhook fly protection screen (3) from guides (4)		
4	Unhook handle (5) from guide rails (6)		
5	Remove fly protection screen (3) with handle (5) from inner frame (1)		
6	Unscrew screws from handle (5)		

7	Remove top section of handle (5) from top section of handle (5)		
8	Separate fly protection screen (3) from handle (5)		
9	Install in the reverse order		

MODEL 903.662

with CODE (ZU8) National version for USA

with CODE (Z29) "James Cook" touring camper, NAFTA

with CODE (DL1) Electric lifting/tilting roof window, James Cook

1 Cover

2 Connector

3 Battery

4 Remote control

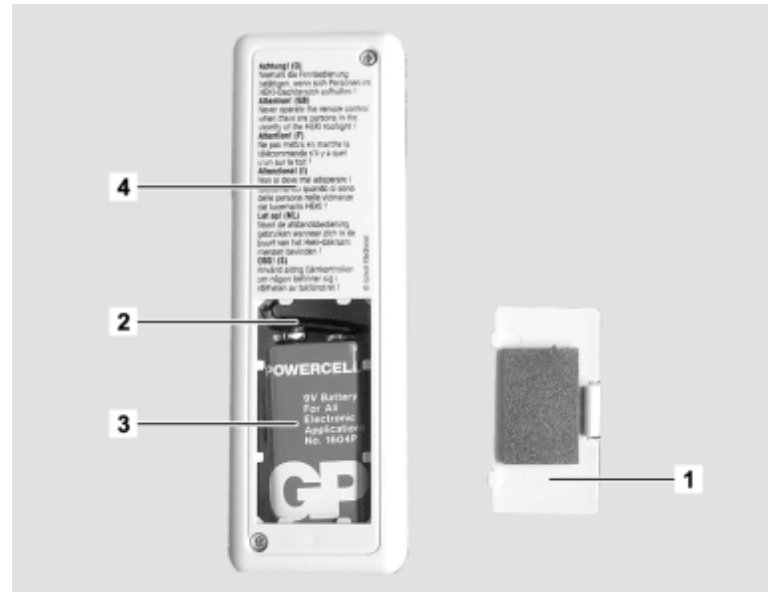

D77.55-0001-11

☒ ☒	Remove/Install		
1	Unlock cover (1) and open		
2	Remove connector (2) from battery (3)		
3	Remove battery (3) from remote control (4)		
4	Install in the reverse order		

MODEL 903.662

with CODE (ZU8) National version for USA

with CODE (Z29) "James Cook" touring camper, NAFTA

with CODE (DL1) Electric lifting/tilting roof window, James Cook

1 Electrical connector

2 Bolts

3 Motor

4 Shaft

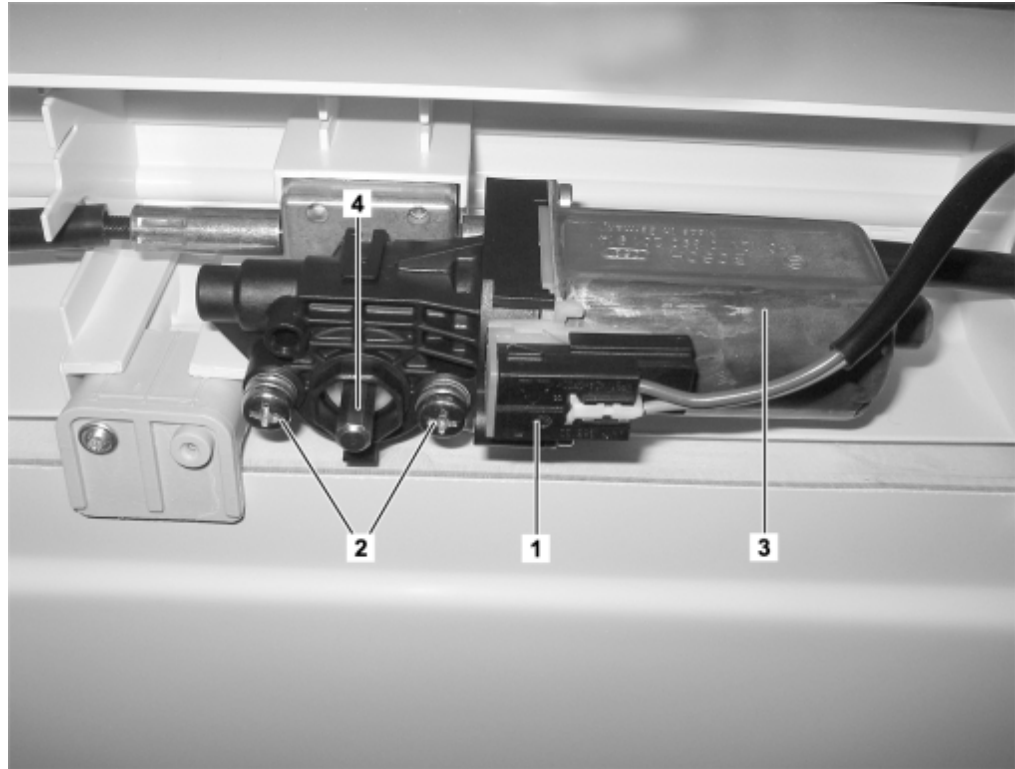

D77.55-0005-06

☒ ☒	Remove/Install		
⚠ Danger!	Risk of injury caused by body parts becoming jammed, pinched or severed by doors, covers, flaps or by loose components	Keep body parts well clear when moving doors, covers, flaps and components. Wear protective gloves and protective shoes.	AS00.00-Z-0025-01A
1	Remove lifting/tilting roof window inner frame		AR77.55-D-5000A
2	Unlock electrical connector (1) and unplug		
3	Unscrew bolts (2)		
4	Remove motor (3) from shaft (4)		
5	Install in the reverse order		

MODEL 903.662

with CODE (ZU8) National version for USA

with CODE (Z29) "James Cook" touring camper, NAFTA

with CODE (DL1) Electric lifting/tilting roof window, James Cook

1 Inner frame



2 Bolts

3 Electrical lines

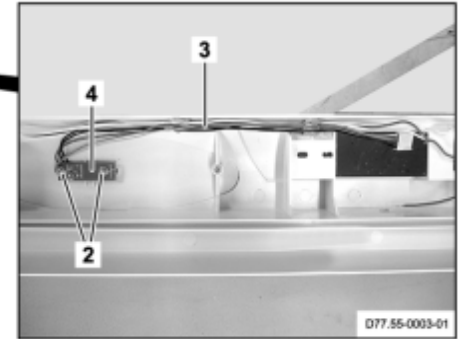
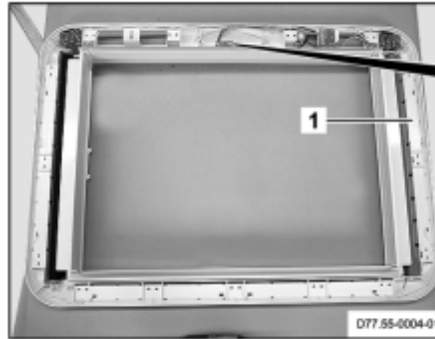
4 Receiver



D77.55-0002-04

	Remove/Install		
 Danger!	Risk of injury caused by body parts becoming jammed, pinched or severed by doors, covers, flaps or by loose components	Keep body parts well clear when moving doors, covers, flaps and components. Wear protective gloves and protective shoes.	AS00.00-Z-0025-01A
1	Remove inner frame (1) from tilting/lifting roof window		AR77.55-D-5000A
2	Unscrew bolts (2)		
3	Loosen electrical lines (3) from inner frame (1) of tilting/lifting roof window		
4	Remove receiver (4) from lifting/tilting roof window remote control		
5	Install in the reverse order		

MODEL 903.662

with CODE (ZU8) National version for USA

with CODE (Z29) "James Cook" touring camper, NAFTA

E75 License plate illumination

E76 License plate illumination



D82.10-1111-01

	Remove/Install		
1	Unclip license-plate illuminations (E75, E76)		
2	Detach electric couplings from license plate illuminations (E75, E76)		
3	Install in the reverse order		
4	Perform function check of license plate illuminations (E75, E76)		

MODEL 903.662

with CODE (ZU8) National version for USA

with CODE (Z29) "James Cook" touring camper, NAFTA

In raised roof

1 High roof

2 Bolts

3 Electrical connectors

E12 Additional stop lamp

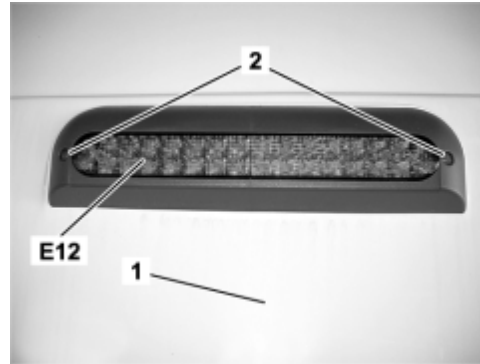

D82.10-1109-01

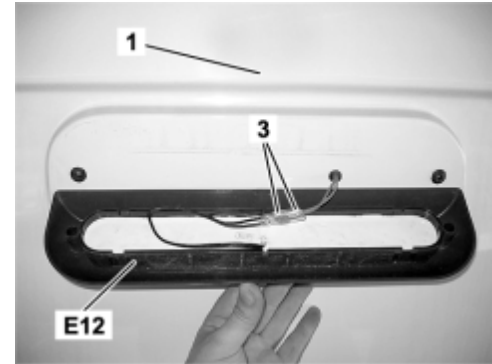

D82.10-1110-01

☒ ☒	Remove/Install		
⚠ Danger!	Risk of death caused by falling from vehicle roof. Risk of injury to other persons caused by falling objects during work in roof area.	Perform works on or in the area of the vehicle roof only on suitable auxiliary implements (ladders, scaffolding, assembly platforms). Secure working area adequately.	AS65.00-Z-0002-01B
1	Unscrew bolts (2)		
2	Remove additional stop lamp (E12)	i Installation: Observe routing of electrical line behind additional stop lamp (E12).	
3	Disconnect electrical couplings (3)		
4	Install in the reverse order		
5	Perform a function test		



MODEL 903.662

with CODE (ZU8) National version for USA

with CODE (Z29) "James Cook" touring camper, NAFTA
interior light switch in longitudinal wall cupboard

D82.20-0028-08

*1 Switches**2 Electrical connectors*

 	Remove/Install		
1	Unclip switch (1)		
2	Unplug electrical connectors (2)		
3	Install in the reverse order		
4	Perform function test of switch (1)		

MODEL 903.662

with CODE (ZU8) National version for USA

with CODE (Z29) "James Cook" touring camper, NAFTA
interior light switch for wet cell

1 Switches

2 Electrical connectors

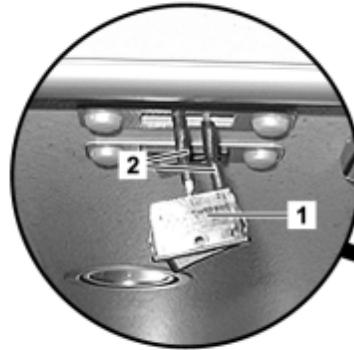

D82.20-0025-05

☒ ☒	Remove/Install		
1	Unclip switch (1)		
2	Unplug electrical connectors (2)		
3	Install in the reverse order		
4	Perform function test of switch (1)		

MODEL 903.662

with CODE (ZU8) National version for USA

with CODE (Z29) "James Cook" touring camper, NAFTA



D82.20-0013-08

1 Switches

2 Connector

	Remove/Install		
1	Unclip switch (1)		
2	Disconnect connector		
3	Install in the reverse order		
4	Perform function test on switch (1)		

MODEL 903.662

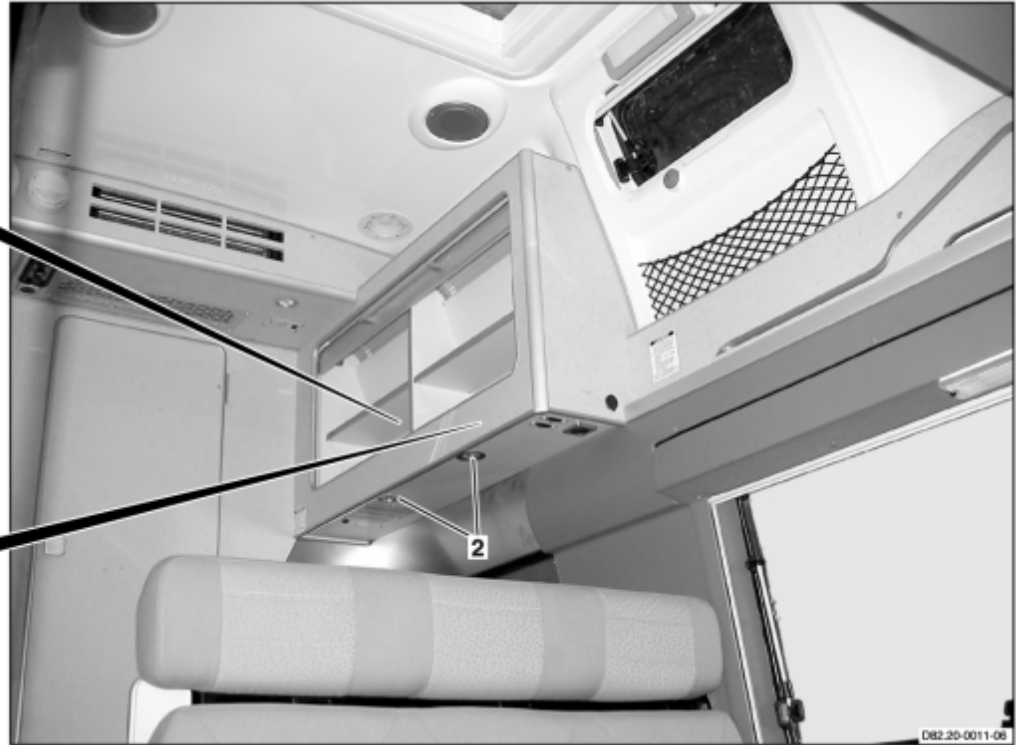
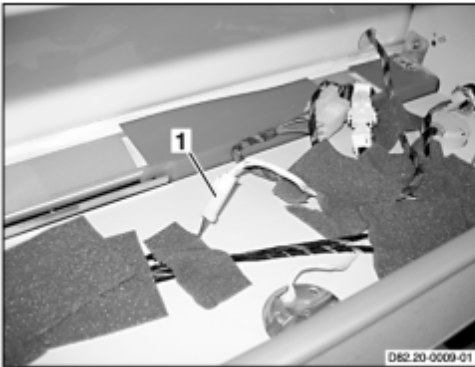

with CODE (ZU8) National version for USA

with CODE (Z29) "James Cook" touring camper, NAFTA



D82.20-0010-09

*1 Electrical connectors**2 Lamps*

 	Remove/Install		
1	Remove floor in cabinet		AR86.60-D-0050-01A
2	Disconnect electrical connectors (1).		
3	Unclip lamps (2)		
4	Remove lamps (2)		
5	Install in the reverse order		
6	Perform function test on lamps (2)		

MODEL 903.662

with CODE (ZU8) National version for USA

with CODE (Z29) "James Cook" touring camper, NAFTA

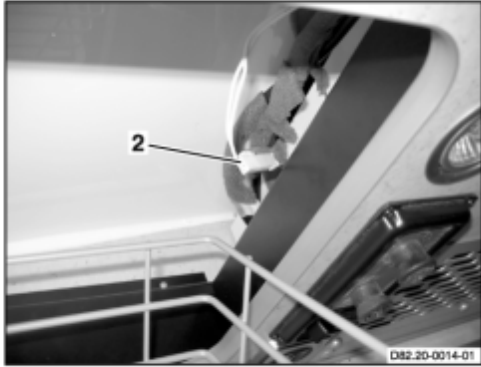

D82.20-0016-08

1 Stowage compartment

2 Electrical connector

3 Bulb

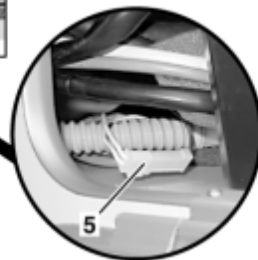

D82.20-0019-08

4 Flap

5 Electrical connector

6 Bulb

	<p>Remove/Install</p>		
<p>1</p>	<p>Open stowage compartment (1)</p>		

2	Separate electrical connector (2)		
3	Unclip lamp (3)		
4	Remove lamp (3)		
5	Open flap (4) in shower room		
6	Disconnect plug and socket connection (5)		
7	Unclip lamp (6)		
8	Remove lamp (6)		
9	Install in the reverse order		
10	Perform function test on lamps		

MODEL 903.662

with CODE (ZU8) National version for USA

with CODE (Z29) "James Cook" touring camper, NAFTA

- 1 Caps
- 2 Lamp lens
- 3 Gasket
- 4 Bolts
- 5 Interior lamp
- 6 Electrical wiring

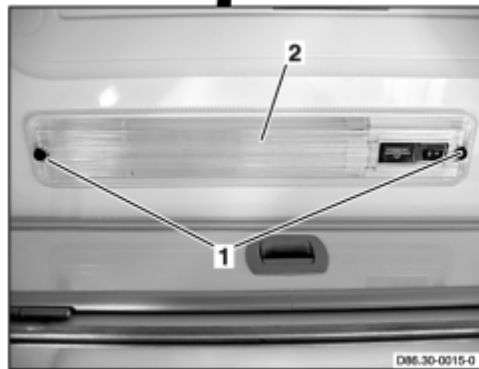
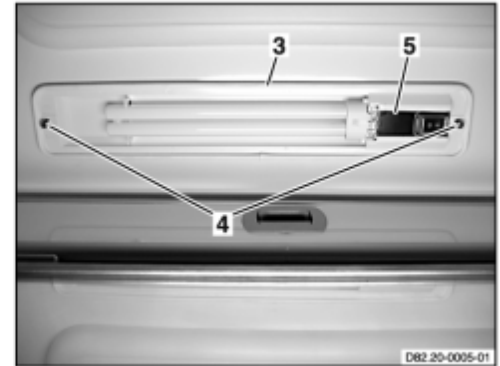

D82.20-0007-06

☒ ☒	Remove/Install		
1	Unscrew covering caps (1)		
2	Remove lamp lens (2)	i Installation: Ensure that seal (3) is in correct installation position.	
3	Remove bolts (4)		
4	Remove interior lamp (5)		
5	Disconnect electrical leads (6)		
6	Install in the reverse order		
7	Perform function check on interior lamp (5)		

MODEL 903.662

with CODE (ZU8) National version for USA

with CODE (Z29) "James Cook" touring camper, NAFTA

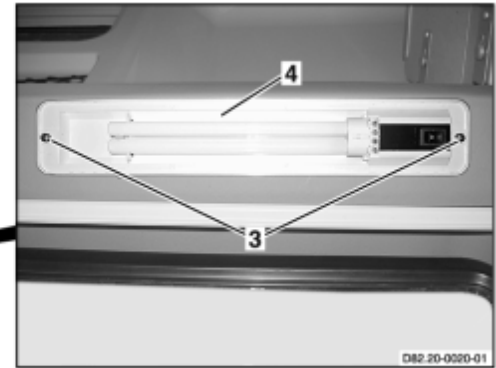

D82.20-0022-09

1 Caps
2 Lamp lens
3 Bolts

4 Bulb
5 Electrical wiring

	Remove/Install		
1	Unscrew covering caps (1)		
2	Remove lamp lens (2)		
3	Remove screws (3)		
4	Remove lamp (4)		
5	Disconnect electrical leads (5)		
6	Install in the reverse order		
7	Perform function check on lamp (4)		

MODEL 903.662

with CODE (ZU8) National version for USA

with CODE (Z29) "James Cook" touring camper, NAFTA

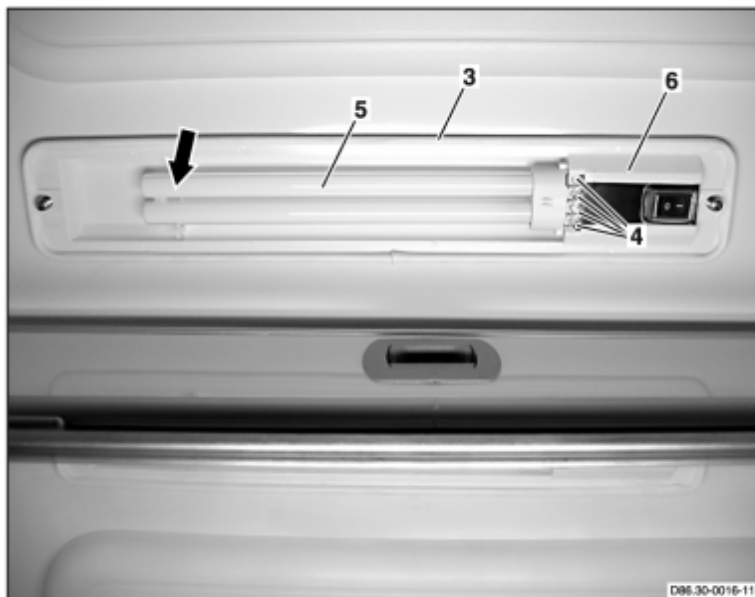
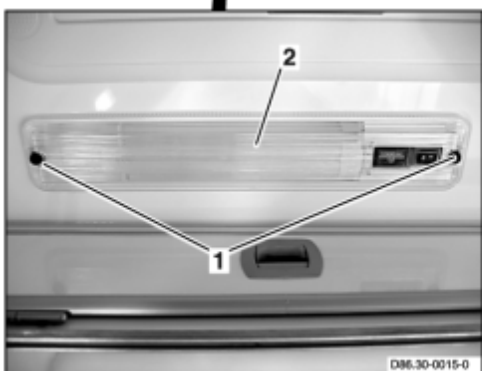

D86.30-0017-09

1 Caps
2 Lamp glass
3 Gasket

4 Bolts
5 Bulb
6 Interior lamp

☒ ☒	Remove/Install		
1	Unscrew caps (1)		
2	Remove lamp glass (2)	i Installation: Ensure correct installation position of seal (3).	
3	Undo bolts (4)		
4	Unclip bulb (5) (arrow)		
5	Remove bulb (5)		
6	Install in the reverse order		
7	Check interior lamp (6) for proper function		

MODEL 903.662

with CODE (ZU8) National version for USA

with CODE (Z29) "James Cook" touring camper, NAFTA



1 Bulb

2 Catch lugs

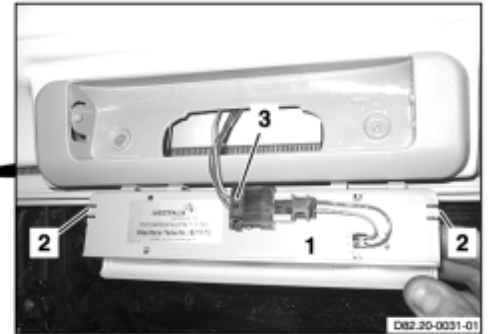
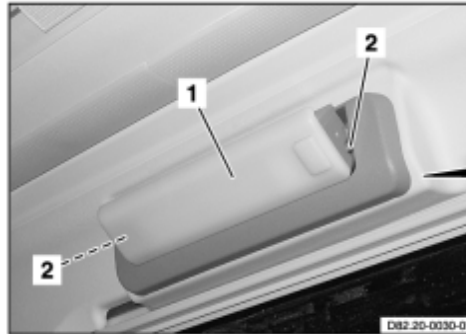
3 Electrical connector



D82.20-0029-04

 	Remove/Install		
1	Slightly tilt lamp (1) forward		
2	Unlock catch lugs (2)	 Use a suitable tool.	
3	Fully tilt lamp (1) forward		
4	Unclip lamp (1) upwards		
5	Disconnect electrical connector (3)		
6	Install in the reverse order		

MODEL 903.662

with CODE (ZU8) National version for USA

with CODE (Z29) "James Cook" touring camper, NAFTA

Speaker in raised roof

1 Bolts



2 Covering

3 Loudspeaker

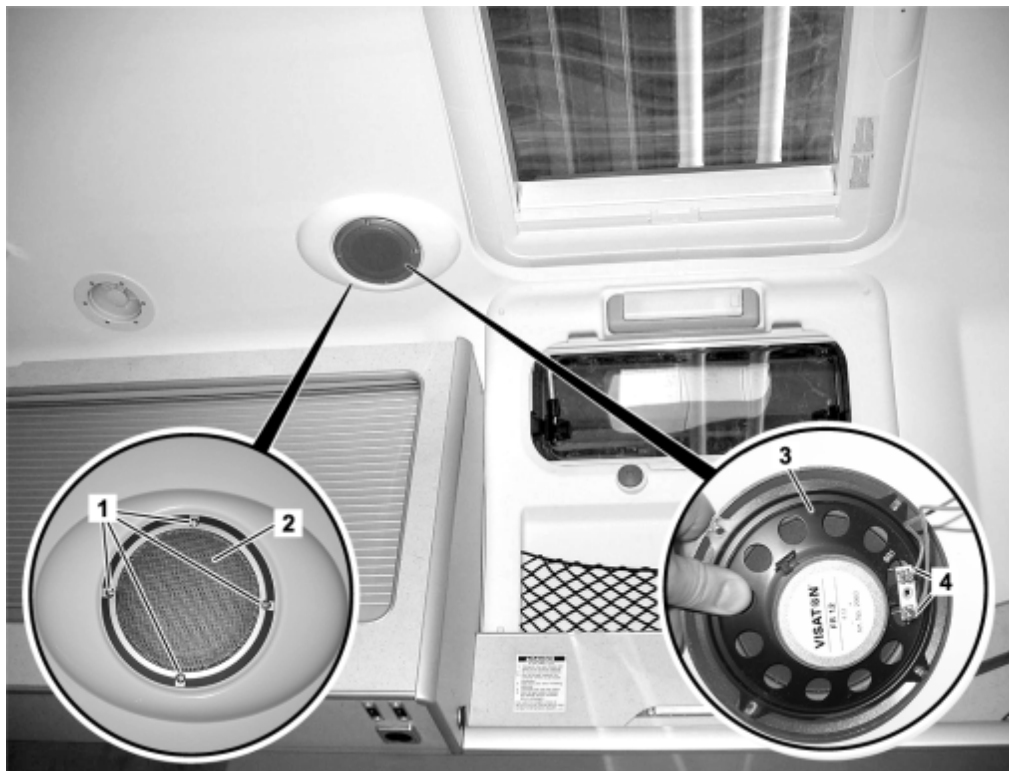
4 Electrical connectors



D82.62-1104-06

 	Remove/Install		
1	Remove screws (1)		
2	Remove speaker (3) with covering (2)		
3	Detach electrical connectors (4) from speaker (5)		
4	Install in the reverse order		
5	Perform a function test	 Switch radio on, off (see operator's manual).	

MODEL 903.662

with CODE (ZU8) National version for USA

with CODE (Z29) "James Cook" touring camper, NAFTA



On horizontal wall cabinet

1 Bolts

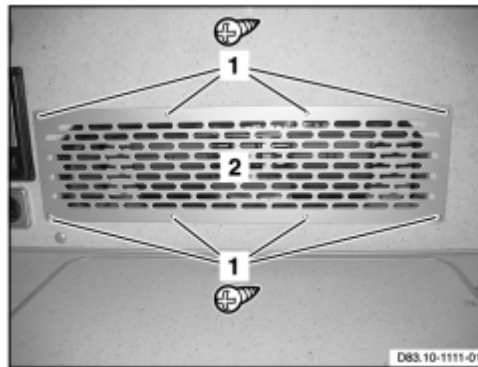
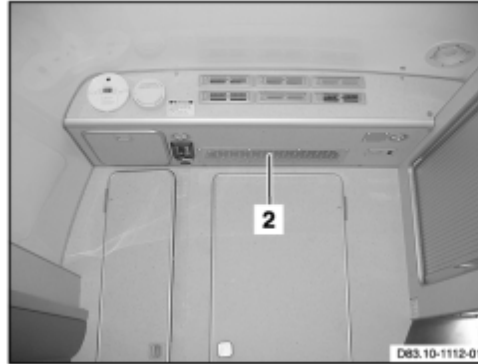
2 Ventilation grille



D83.10-1113-06

 	Remove/Install		
1	Remove caps from bolts (1)		
2	Remove screws (1)		
3	Remove ventilation grille (2)		
4	Install in the reverse order		

MODEL 903.662

with CODE (ZU8) National version for USA

with CODE (Z29) "James Cook" touring camper, NAFTA



In horizontal wall cabinet

1 Air nozzle

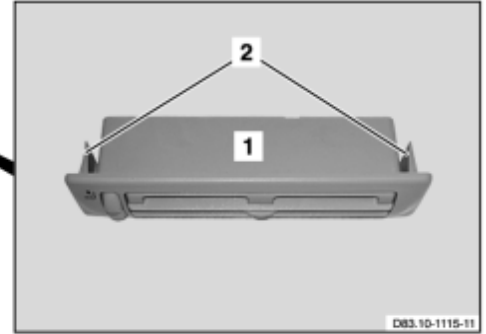
2 Lugs



D83.10-1116-04

 	Remove/Install		
1	Unlock air outlet (1) on the lugs (2) on both sides		
2	Remove air outlet (1) from horizontal wall cabinet		
3	Install in the reverse order		

MODEL 903.662

with CODE (ZU8) National version for USA

with CODE (Z29) "James Cook" touring camper, NAFTA

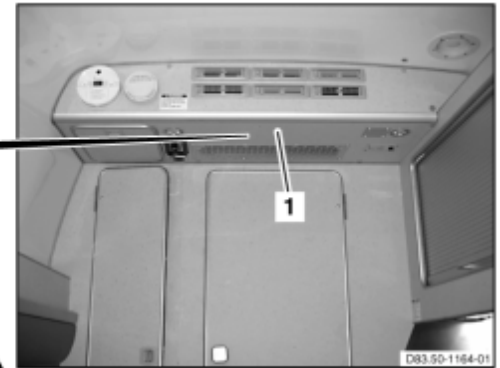

D83.50-1166-08

1 Hanging cabinet
2 Evaporator housing

3 Drain hoses

4 Electrical connectors

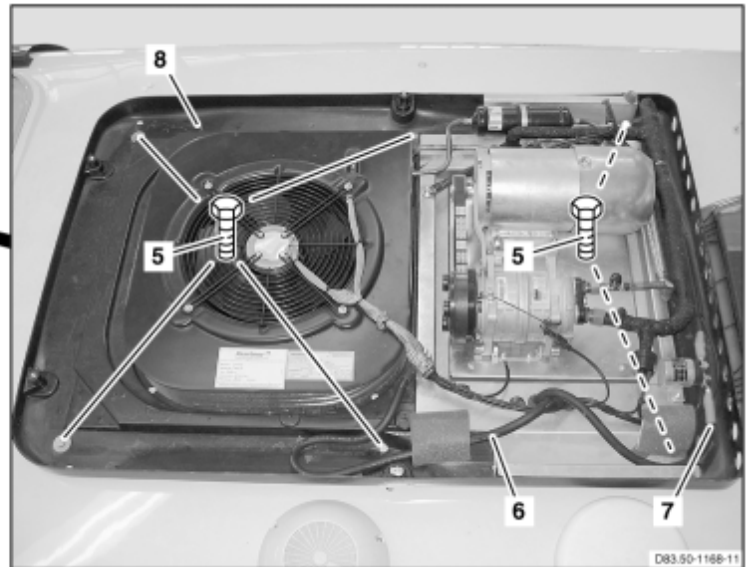

D83.50-1169-08

5 Bolts
6 Ground cable





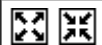





7 Positive cable

8 Roof air conditioning



Remove

⚠ Danger!	Risk of death from coming into contact with electrical parts of the 110 V system Risk of injury caused by burns, which can be produced by electrical shocks or by body parts coming in direct contact with electrical currents.	Do not touch any conductive parts of the 110 V system.	AS00.00-Z-0027-01A
⚠ Danger!	Risk of death caused by falling down from the roof of the vehicle. Risk of injury to other persons caused by falling objects during work in the area of the roof.	Work on or in the area of the vehicle's roof may only be performed on suitable equipment (ladders, scaffolds, lifting platforms). Sufficiently secure the area to be worked in.	AS65.00-Z-0002-01B
⚠ Danger!	Risk of injury caused by exiting refrigerant and by contact with the components of the refrigerant system	Wear protective clothing, safety gloves and safety glasses	AS86.61-Z-0002-01A
1	Switch off roof air conditioning (8)	i See Operator's Manual	
2	Disconnect external 110 V feed line from the vehicle	i See Operator's Manual	
3	Remove web-type fuse	Of the roof air conditioning in the engine compartment	AR54.15-D-2100B
4	Remove hanging cabinet (1)	Lateral hanging cabinet	AR86.60-D-0051A
5	Remove foam pad from the evaporator housing (2)		
6	Remove electrical lines from the evaporator housing (2)		
7	Undo hose clamps for drain hoses (3)	i Left and right side	
8	Detach drain hoses (3) from the evaporator housing (2)	i Left and right side	
9	Disconnect electrical connectors (4).		
10	Remove cover for roof air conditioning (8) on vehicle roof		AR83.30-D-1010A
11	Disconnect roof air conditioning (8) from the vehicle's line system		AR83.30-D-1000-01A
12	Unscrew bolts (5).		
13	Release roof air conditioning (8) from the vehicle roof	i Helper required.	
		i	

		Roof air conditioning (8) is sealed on the vehicle roof using rooflight tape.	
14	Lift roof air conditioning (8) out of the vehicle roof	 Helper required.	
		 Lift roof air conditioning (8) out of the vehicle roof using suitable lifting device.	
	Install		
15	Prepare installation location of roof air conditioning (8) for installation	 Insert roof air conditioning (8) into the vehicle roof immediately after applying the rooflight sealing tape.	AR83.30-D-1000-03A
16	Insert roof air conditioning (8) into the vehicle roof	 Helper required.	
		 Insert roof air conditioning (8) into the vehicle roof using suitable lifting device.	
17	Screw in screws (5)		
18	Connect roof air conditioning (8) to vehicle's line system		AR83.30-D-1000-05A
19	Install cover for roof air conditioning (8) on vehicle roof		AR83.30-D-1010A
20	Connect electrical connectors (4)		
21	Connect drain hoses (3) to the evaporator housing (2)	 Left and right side	
22	Secure hose clamps for drain hoses (3)	 Left and right side	
23	Secure electrical lines to the evaporator housing (2)	 Use new foam pads.	
24	Install wall cupboard (1)	Lateral hanging cabinet	AR86.60-D-0051A
25	Install web-type fuse	Of the roof air conditioning in the engine compartment	AR54.15-D-2100B
26	Perform a function test	 Switch roof air conditioning (8) off and on.	

MODEL 903.662

with CODE (ZU8) National version for USA

with CODE (Z29) "James Cook" touring camper, NAFTA

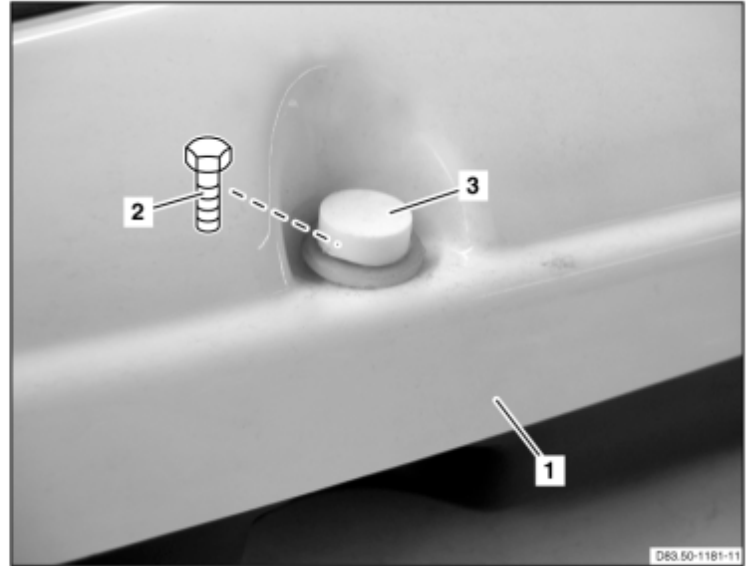





D83.50-1182-08

1 Cover

2 Bolts

3 Cap

	Remove/Install		
 Danger!	Risk of death caused by falling down from the roof of the vehicle. Risk of injury to other persons caused by falling objects during work in the area of the roof.	Work on or in the area of the vehicle's roof may only be performed on suitable equipment (ladders, scaffolds, lifting platforms). Sufficiently secure the area to be worked in.	AS65.00-Z-0002-01B
 Danger!	Risk of injury caused by exiting refrigerant and by contact with the components of the refrigerant system	Wear protective clothing, safety gloves and safety glasses	AS86.61-Z-0002-01A
1	Switch off roof air conditioning	 See Operator's Manual	
2	Remove covering caps (3)		
3	Unscrew bolts (2)		
4	Remove cover (1)		
5	Install in the reverse order		

AR83.30-D-1760C

Draining, evacuating and refilling air conditioning, checking function and checking for leaks

11.8.04

MODEL 903.662

with CODE (ZU8) National version for USA

with CODE (Z29) "James Cook" touring camper, NAFTA

Roof air conditioning made by Kerstner, model 103K

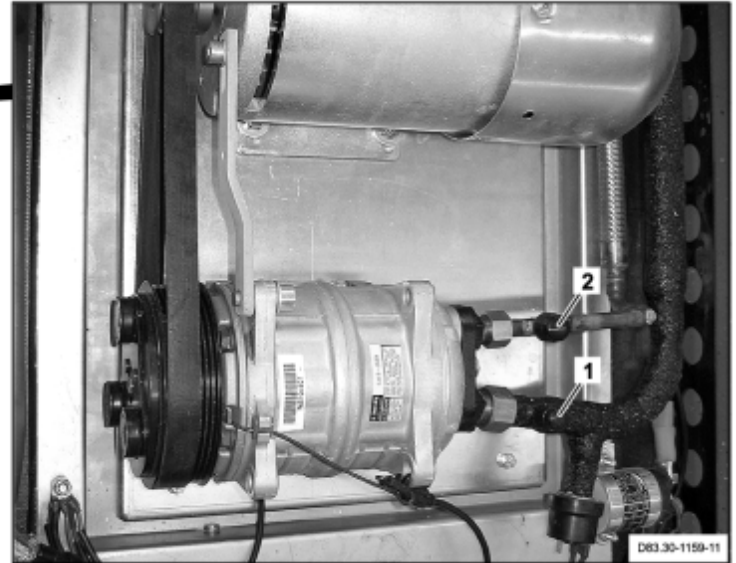



















D83.30-1160-08

1 Test and filling valve, low-pressure side

2 Test and filling valve, high-pressure side

	Draining		
⚠ Danger!	Risk of death caused by falling down from the roof of the vehicle. Risk of injury to other persons caused by falling objects during work in the area of the roof.	Work on or in the area of the vehicle's roof may only be performed on suitable equipment (ladders, scaffolds, lifting platforms). Sufficiently secure the area to be worked in.	AS65.00-Z-0002-01B
⚠ Danger!	Risk of explosion from welding or soldering work on closed air conditioning system. Risk of poisoning from inhaling overheated refrigerant vapors. Risk of injury to skin and eyes caused by contact with liquid refrigerant.	Never perform welding work on or near a closed air conditioning system. No smoking or open flames. Wear safety glasses and protective gloves. Work only in well ventilated areas. Carry out repair work on the air conditioning system circuit only after the system has been discharged.	AS83.00-Z-0001-01A
⚠ Danger!	Risk of injury caused by exiting refrigerant and by contact with	Wear protective clothing, safety gloves and safety glasses	AS86.61-Z-0002-01A

	the components of the refrigerant system		
	Protect air conditioning circuit and components from moisture when carrying out repair work	Model 903.662	AH83.30-N-0005-01C
	Notes on handling refrigerant R134a	Model 903.662	AH83.30-N-0003-01B
1	Remove cover for roof air conditioning on vehicle roof		AR83.30-D-1010A
2	Unscrew protective caps from test and filling valve, low side (1) and from test and filling valve, high side (2)		
3	Connect extraction and filling unit to test and filling valve, low side (1) and to test and filling valve, high side (2)	 See device manufacturer's operator's manual.	
		 Air conditioning draining, evacuating and filling equipment for refrigerant R134a	WH58.30-Z-1003-16A
4	Discharge air conditioning system	 See device manufacturer's operator's manual.	
5	Drain separated compressor oil from the extraction and filling unit and measure the exact quantity	 See device manufacturer's operator's manual.	
	Evacuating		
6	Clean air conditioning system and evacuate	 See device manufacturer's operator's manual.	
	Charging		
7	Refill compressor oil	 Before filling in refrigerant, replace drained amount of compressor oil with new compressor oil. The specified total filling capacity must not be exceeded.	
		 See device manufacturer's operator's manual.	
		 Total filling capacity (oil) of new system (in refrigerant compressor)	BF83.30-N-1002-01F
		 Total filling capacity (oil) of air conditioning system (including	BF83.30-N-1003-01F

		refrigerant compressor)	
8	Fill air conditioning system	 See device manufacturer's operator's manual.	
		 Total filling quantity, refrigerant	BF83.30-N-1001-01F
9	Disconnect extraction and filling unit from the test and filling valve, low side (1) and from the test and filling valve, high side (2)	 See device manufacturer's operator's manual.	
		 Air conditioning draining, evacuating and filling equipment for refrigerant R134a	WH58.30-Z-1003-16A
10	Screw protective caps onto the test and filling valve, low side (1) and onto the test and filling valve, high side (2)		
11	Install cover for roof air conditioning on vehicle roof		AR83.30-D-1010A
	Check		
12	Check air conditioning for proper function	 Switch roof air conditioning on and off and check all component functions relevant to the function of the roof air conditioning (see operator's manual).	
13	Inspect air conditioning system for leaks with leak detector	 In view of the fact that the refrigerant is heavier than air, the check with the probe of the leak tester must always be carried out below the suspected leakage point.	
		 Air conditioning system leak detector	WH58.30-Z-1001-27A

Air conditioning

Number	Designation	Model	903.662
BF83.30-N-1001-01F	Total filling quantity, refrigerant		kg 0,800
		Specifications for Operating Fluids	Sheet BB00.40-P-0361-00A
BF83.30-N-	Total filling capacity (oil) of new		cm3 190

1002-01F	system (in refrigerant compressor)	Specifications for Operating Fluids	Sheet	BB00.40-P-0362-00A
BF83.30-N-1003-01F	Total filling capacity (oil) of air conditioning system (including refrigerant compressor)		cm3	210
		Specifications for Operating Fluids	Sheet	-

Commercially available tools (see Workshop Equipment Manual)

Number	Designation	Make (e. g.)	Order number
WH58.30-Z-1003-16A	Air conditioning draining, evacuating and filling equipment for refrigerant R134a	Behr GmbH u. Co. KG D-70469 Stuttgart	36.113.00.002 SECUmat 134a
WH58.30-Z-1001-27A	Air conditioning leak detector	Behr GmbH u. Co. KG 70469 Stuttgart	988 047 Type 5650

MODEL 903.662

with CODE (ZU8) National version for USA

with CODE (Z29) "James Cook" touring camper, NAFTA

Roof air conditioning

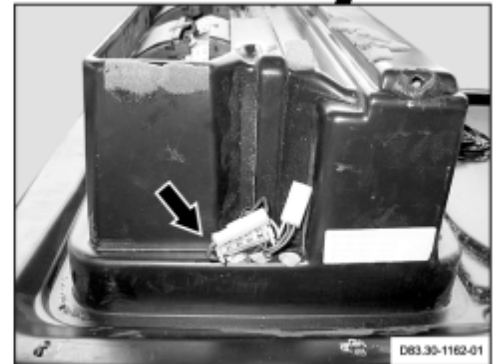
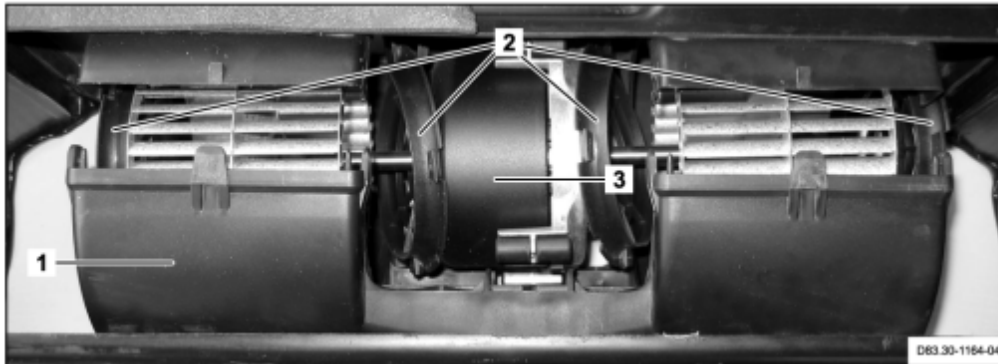
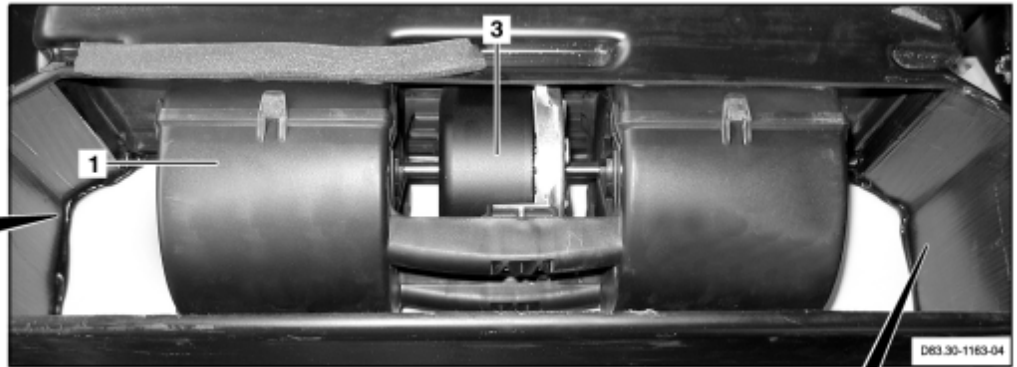
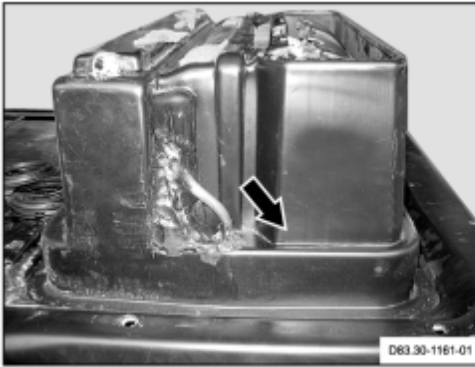

D83.30-1165-09

1 Blower housing cover

2 Ventilation grille

3 Blower motor

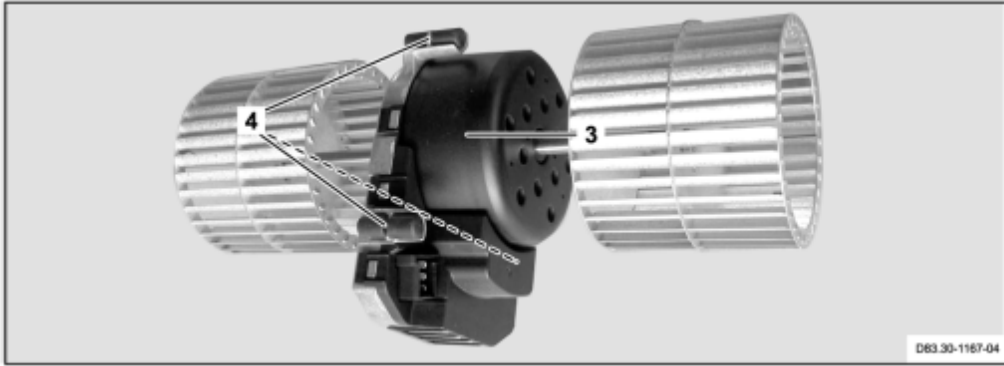
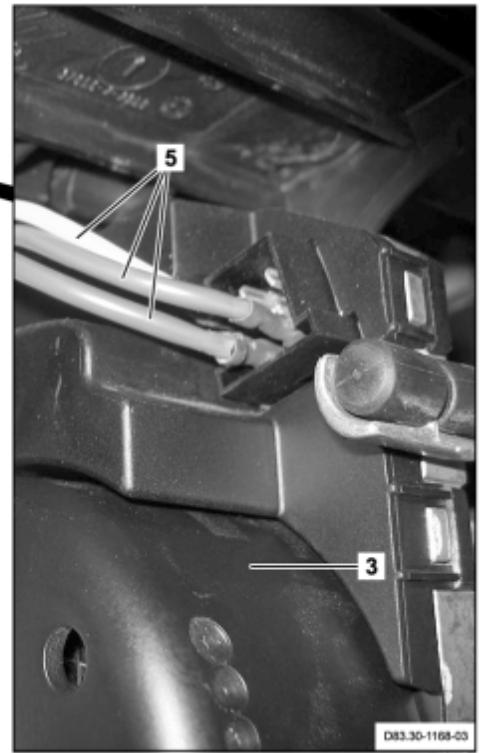
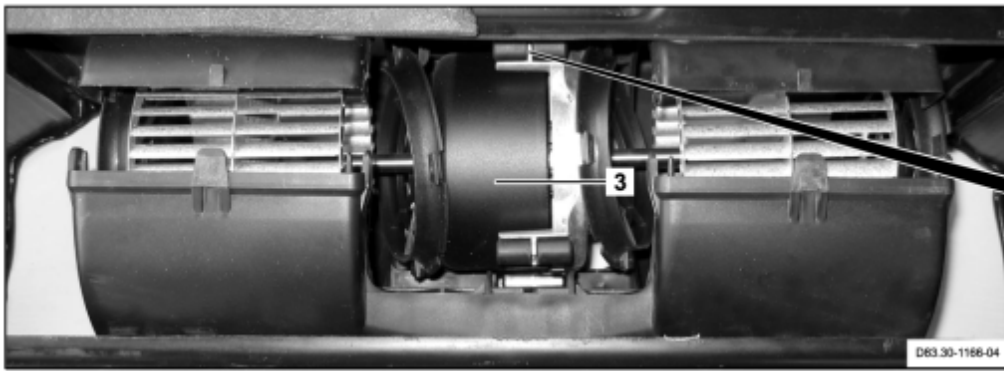







D83.30-1169-09

3 Blower motor

4 Rubber bushing

5 Electrical connectors

	Remove/Install		
⚠ Danger!	Risk of injury through leaking refrigerant and through contact with components of the refrigerant system	Wear protective clothing, safety gloves and safety glasses	AS86.61-Z-0002-01A
1	Remove roof air conditioning		AR83.30-D-1000A
2	Unlatch tabs on top and side of blower housing cover (1)		
3	Fold up top of blower housing cover (1)		
4	Remove side ventilation grilles (2)	All ventilation grilles (2).	
		Installation: Observe installation position of ventilation grilles (2).	
5	Drill mounting holes on both sides of A/C housing (arrow)	Hole diameter Ø 16 mm.	
		Installation: Close holes with sealant.	
		Core drill Ø 16 up to 30.5 mm	WH58.30-Z-1003-

			34A
		Drill (electric/pneumatic)	WE58.40-Z-1001-03A
		Wet/dry vacuum cleaner	WE58.40-Z-1005-03A
6	Unlatch tabs on lower part of blower housing cover (1)	 Avoid high tractive or compressive forces to prevent breakage on blower housing.	
		 Unlatching through the mounting holes using a sufficiently long screwdriver.	
7	Remove blower housing cover (1)	 Installation: Ensure that the rubber mounts (4) of the blower motor (3) are properly seated in the blower housing cover (1).	
8	Slightly rotate blower motor (3) in A/C housing	 Until the electrical connectors (5) are accessible.	
9	Write down installation position of electrical connectors (5)		
10	Detach electrical connectors (5) from blower motor (3)		
11	Remove blower motor (3)	 Installation: Ensure that the rubber mounts (4) are properly seated on the blower motor (3).	
12	Install in the reverse order		
13	Perform a function test	 Switch roof air conditioning on, off (see operator's manual).	

Commercially available tools (see Workshop Equipment Manual)

Number	Designation	Make (e. g.)	Order number
WH58.30-Z-1003-34A	Core drill, dia. Ø16 - 30.5 mm	HAHN & KOLB Borsigstr. 50 D-70469 Stuttgart	11 403 010

Workshop equipment/MB testers (see Workshop Equipment Manual)

WE58.40-Z-1001-03A	Drill (electric/pneumatic)
WE58.40-Z-1005-03A	Wet/dry vacuum cleaner

MODEL 903.662

with CODE (ZU8) National version for USA

with CODE (Z29) "James Cook" touring camper, NAFTA



D83.50-1222-08

1 Cable harness
2 Condenser fan

3 Electrical connector

4 Bolts

☒ ☒	Remove/Install		
<p>⚠ Danger!</p>	<p>Risk of death caused by falling from vehicle roof. Risk of injury to other persons caused by falling objects during work in roof area.</p>	<p>Perform works on or in the area of the vehicle roof only on suitable auxiliary implements (ladders, scaffolding, assembly platforms). Secure working area adequately.</p>	<p>AS65.00-Z-0002-01B</p>
<p>⚠ Danger!</p>	<p>Risk of injury through leaking refrigerant and through contact with components of the refrigerant system</p>	<p>Wear protective clothing, safety gloves and safety glasses</p>	<p>AS86.61-Z-0002-01A</p>
1	Switch off roof air conditioning	<p>i See Operating Instructions</p>	
2	Remove cover of roof air conditioning on vehicle roof		<p>AR83.30-D-1010A</p>
3	Remove tie strap	<p>i Remove in area of wiring harness (1) from condenser fan (2).</p>	
4	Disconnect electrical connector		

	(3)		
5	Separate electrical lines from wiring harness (1) of condenser fan (2)	i Separate the electrical line approx. 5 cm in front of the electrical coupling (3).	
		i Installation: Connect electrical lines of new condenser fan (2) with electrical coupling (3) via solder connector.	
6	Remove bolts (4).		
7	Remove condenser fan (2)		
8	Install in the reverse order		
9	Perform a function test	i Switch roof air conditioning on, off (see operator's manual).	

MODEL 903.662

with CODE (ZU8) National version for USA

with CODE (Z29) "James Cook" touring camper, NAFTA

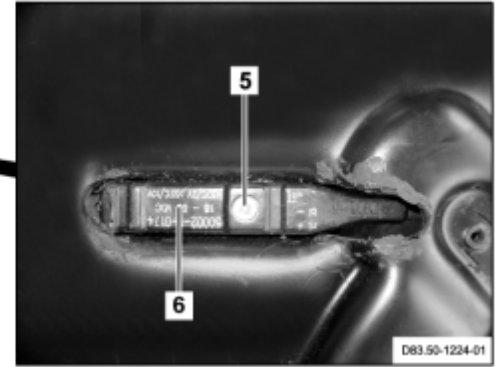
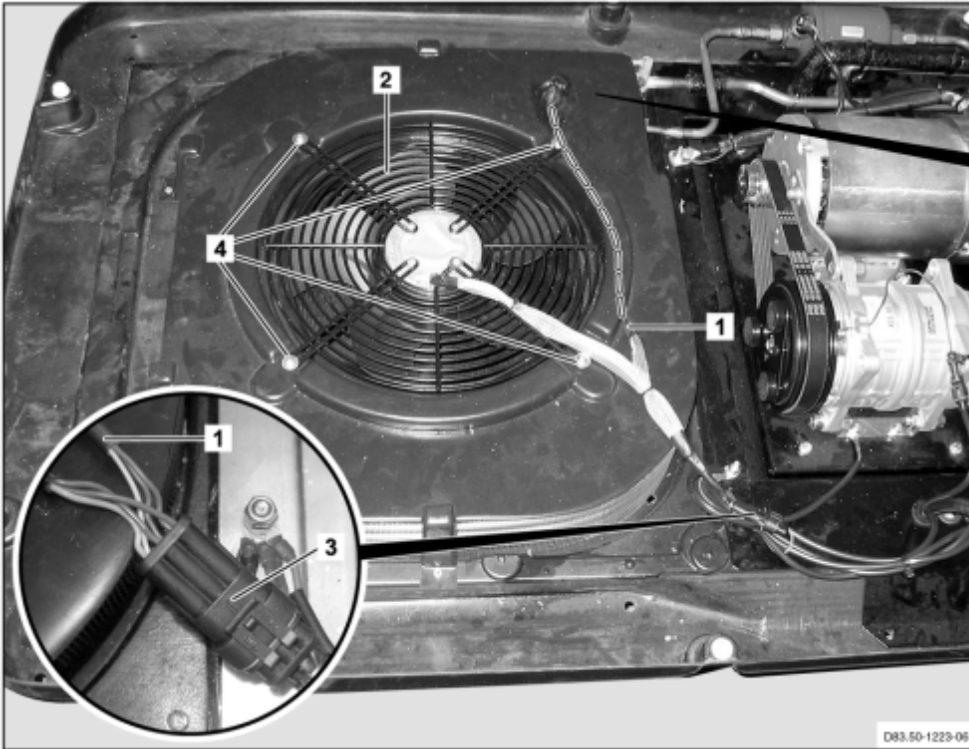

D83.50-1225-09

1 Cable harness
2 Condenser fan

3 Electrical connector
4 Bolts

5 Screw
6 Temperature switch

	<p>Remove/Install</p>		
<p>⚠ Danger!</p>	<p>Risk of death caused by falling from vehicle roof. Risk of injury to other persons caused by falling objects during work in roof area.</p>	<p>Perform works on or in the area of the vehicle roof only on suitable auxiliary implements (ladders, scaffolding, assembly platforms). Secure working area adequately.</p>	<p>AS65.00-Z-0002-01B</p>
<p>⚠ Danger!</p>	<p>Risk of injury through leaking refrigerant and through contact with components of the refrigerant system</p>	<p>Wear protective clothing, safety gloves and safety glasses</p>	<p>AS86.61-Z-0002-01A</p>
<p>1</p>	<p>Switch off roof air conditioning</p>	<p> See Operating Instructions</p>	
<p>2</p>	<p>Remove cover of roof air conditioning on vehicle roof</p>		<p>AR83.30-D-1010A</p>

3	Remove tie strap	i Remove in area of wiring harness (1) from temperature switch (6) to electric coupling (3).	
4	Disconnect electrical connector (3)		
5	Separate electrical lines from wiring harness (1) of temperature switch (6)	i Separate the electrical line approx. 5 cm in front of the electrical coupling (3).	
		i Installation: Connect electrical lines of temperature switch (6) with electrical coupling (3) via solder connector.	
6	Remove bolts (4).		
7	Remove condenser fan (2)		
8	Remove sealant from temperature switch (6)		
9	Remove bolt (5).		
10	Remove temperature switch (6).	i In doing this, pull wiring harness (1) of temperature switch (6) out of housing of roof air conditioning.	
11	Install in the reverse order		
12	Perform a function test	i Switch roof air conditioning on, off (see operator's manual).	

MODEL 903.662

with CODE (ZU8) National version for USA

with CODE (Z29) "James Cook" touring camper, NAFTA

1 Roof air conditioning control unit

2 Electrical connector

3 Electrical connector

4 Electrical connector

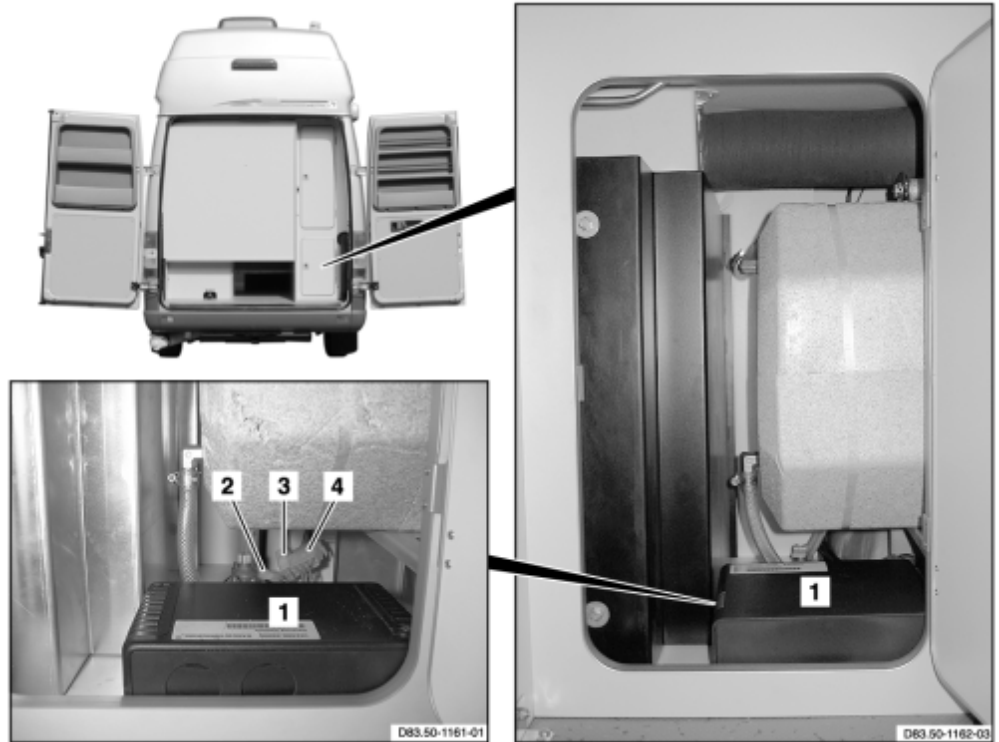

D83.50-1163-06

☒ ☒	Remove/Install		
1	Switch off roof air conditioning (8)	i See Operating Instructions	
2	Disconnect electrical connector (2)		
3	Disconnect electrical connector (3)		
4	Disconnect electrical connector (4)		
5	Remove roof air conditioning control unit (1)	i The roof air conditioning control unit (1) is attached to the vehicle floor with Velcro strip.	
6	Install in the reverse order		
7	Perform a function test	i Switch roof air conditioning on/off (see operator's manual).	

MODEL 903.662

with CODE (ZU8) National version for USA

with CODE (Z29) "James Cook" touring camper, NAFTA

Roof air conditioning load relay at the switching power supply unit

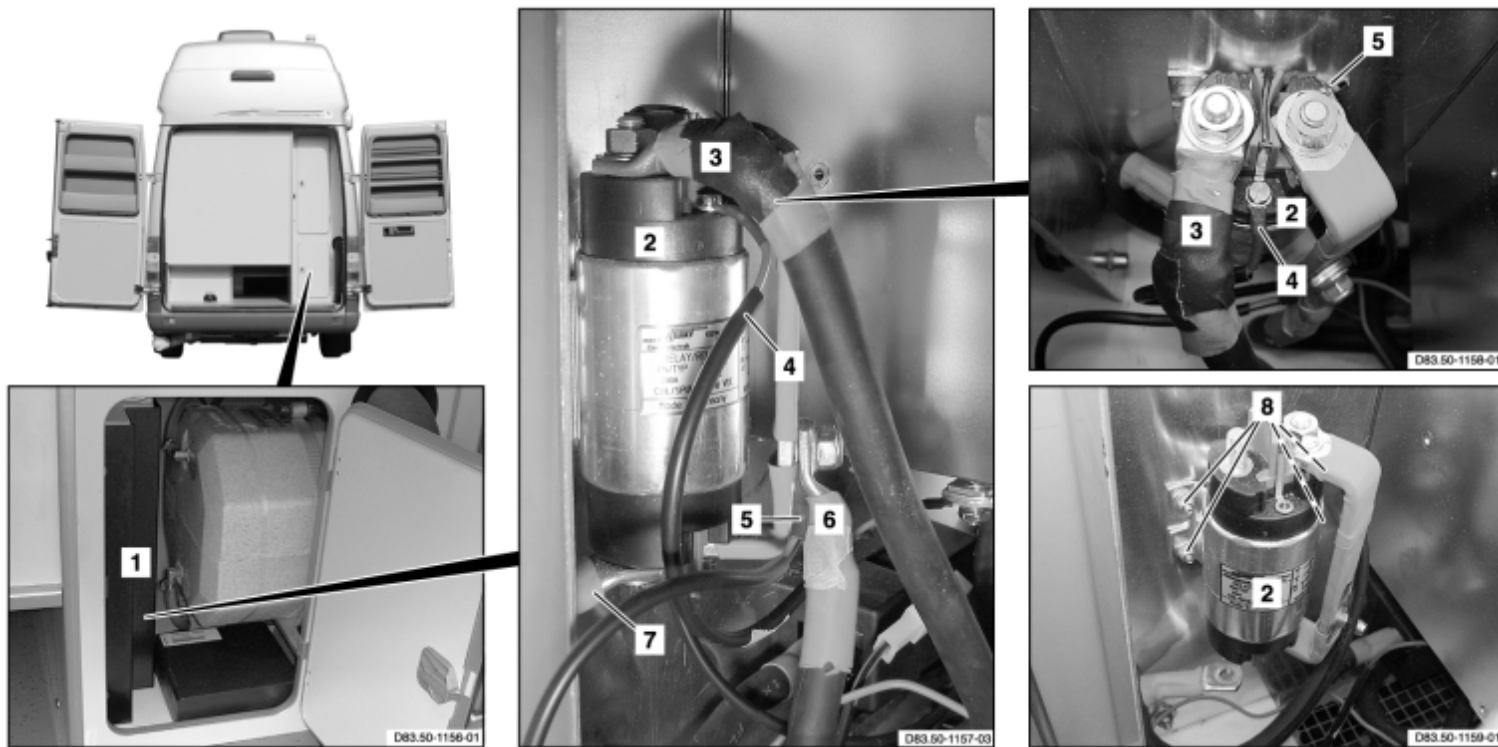

D83.50-1160-09

1 Switching power supply unit
cover

2 Load relay

3 Electrical line

4 Electrical line



5 Electrical line

6 Electrical line

7 Electrical line

8 Nuts

☒ ☒	Remove/Install		
⚠ Danger!	Risk of death from coming into contact with electrical parts of the 110 V system. Risk of injury caused by burns, which can be produced by electrical shocks or by body parts coming in direct contact with electrical currents.	Do not touch any conductive parts of the 110 V system.	AS00.00-Z-0027-01A
1	Switch off roof air conditioning	i See Operator's Manual	
2	Disconnect external 110 V feed line from the vehicle	i See Operator's Manual	
3	Remove web-type fuse	Of the roof air conditioning in the	AR54.15-D-

		engine compartment	2100B
4	Remove switching mode power supply unit cover (1)		AR54.21-D-0030-01A
5	Mark installation position of electrical lines (3, 4, 5, 6, 7) on load relay (2)	 Swapping the electrical lines (3, 4, 5, 6, 7) may result in short circuits and thus in the destruction of electrical components.	
6	Unscrew nut at electrical line (3)		
7	Detach electrical line (3) from load relay (2)		
8	Unscrew bolt at electrical line (4)		
9	Detach electrical line (4) from load relay (2)		
10	Unscrew bolt at electrical line (5)		
11	Detach electrical line (5) from load relay (2)		
12	Unscrew nut at electrical line (6)		
13	Detach electrical line (6) from load relay (2)		
14	Unscrew nut at electrical line (7)		
15	Detach electrical line (7) from load relay (2)		
16	Unscrew nuts (8).	 Installation: Replace self-locking nuts (8).	
17	Remove load relay (2)		
18	Install in the reverse order		
19	Perform a function test	 Switch roof air conditioning on and off (see operator's manual).	

MODEL 903.662

with CODE (ZU8) National version for USA

with CODE (Z29) "James Cook" touring camper, NAFTA

Roof air conditioning load relay at refrigerant compressor

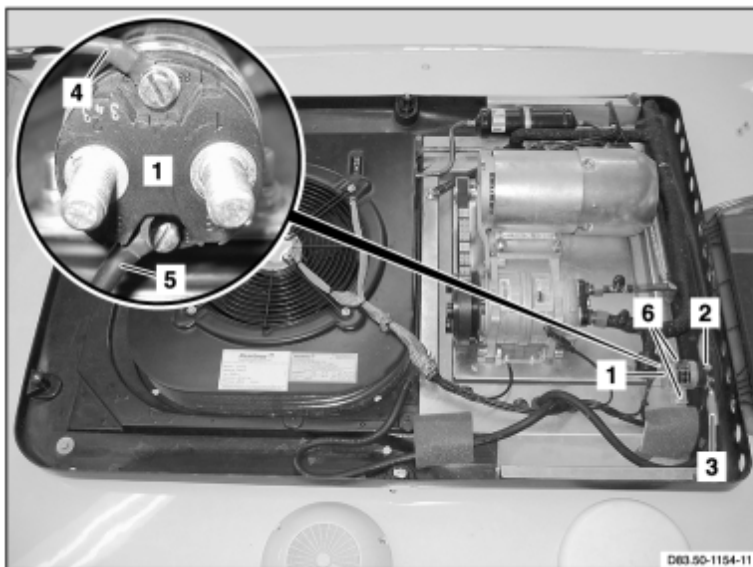





D83.50-1155-08

1 Load relay
2 Electrical line

3 Electrical line
4 Electrical line

5 Electrical line
6 Nuts

☒ ☒	Remove/Install		
⚠ Danger!	Risk of death from coming into contact with electrical parts of the 110 V system. Risk of injury caused by burns, which can be produced by electrical shocks or by body parts coming in direct contact with electrical currents.	Do not touch any conductive parts of the 110 V system.	AS00.00-Z-0027-01A
⚠ Danger!	Risk of death caused by falling down from the roof of the vehicle. Risk of injury to other persons caused by falling objects during work in the area of the roof.	Work on or in the area of the vehicle's roof may only be performed on suitable equipment (ladders, scaffolds, lifting platforms). Sufficiently secure the area to be worked in.	AS65.00-Z-0002-01B
⚠ Danger!	Risk of injury caused by exiting refrigerant and by contact with the components of the refrigerant system	Wear protective clothing, safety gloves and safety glasses	AS86.61-Z-0002-01A
1	Switch off roof air conditioning	i	

		See Operator's Manual	
2	Disconnect external 110 V feed line from the vehicle	 See Operator's Manual	
3	Remove web-type fuse	Of the roof air conditioning in the engine compartment	AR54.15-D-2100B
4	Remove cover for roof air conditioning on vehicle roof		AR83.30-D-1010A
5	Mark installation positions of electrical lines (2, 3, 4, 5) on load relay (1)	 Swapping the electrical lines (2, 3, 4, 5) may result in short circuits and thus in the destruction of electrical components.	
6	Unscrew nut at electrical line (2)		
7	Detach electrical line (2) from load relay (1)		
8	Unscrew nut at electrical line (3)		
9	Detach electrical line (3) from load relay (1)		
10	Unscrew bolt at electrical line (4)		
11	Detach electrical line (4) from load relay (1)		
12	Unscrew bolt at electrical line (5)		
13	Detach electrical line (5) from load relay (1)		
14	Screw off nuts (6)	 Installation: Replace self-locking nuts (6).	
15	Remove load relay (1)		
16	Install in the reverse order		
17	Perform a function test	 Switch roof air conditioning on and off (see operator's manual).	

MODEL 903.662

with CODE (ZU8) National version for USA

with CODE (Z29) "James Cook" touring camper, NAFTA

Roof air conditioning

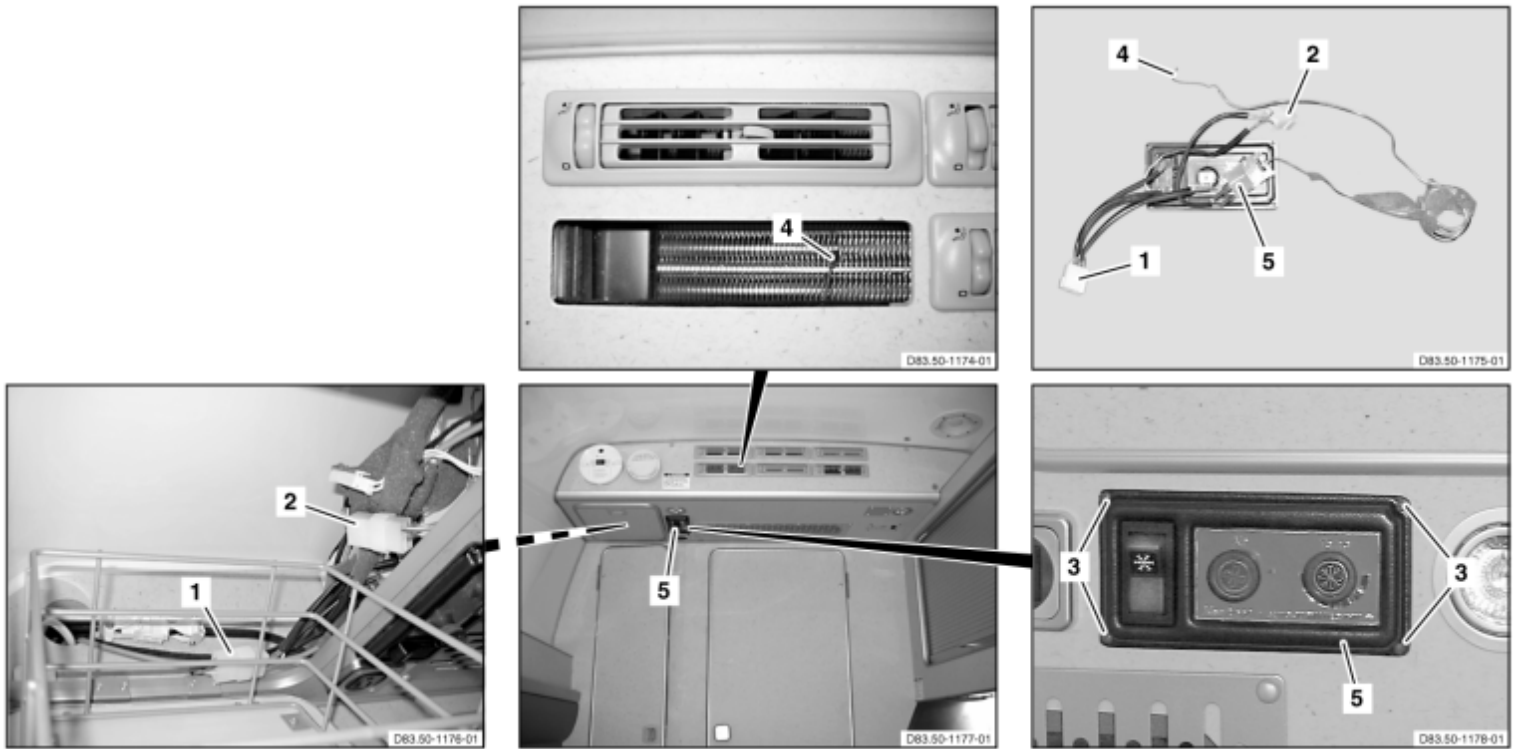

D83.50-1179-09





1 Electrical connector





2 Electrical connector

3 Bolts

4 Temperature sensor

5 Control console

	Remove/Install		
1	Switch off roof air conditioning (8)	 See Operating Instructions	
2	Remove wall cabinet cover panel	 In right side of wall cabinet	AR86.60-D-0051-01A
3	Remove wall cabinet cover panel	 In right rear of wall cabinet	AR86.60-D-0051-01B
4	Remove tie straps from electrical lines of control console (5)	 Installation: use new tie straps.	
5	Disconnect electrical connector (1)		
6	Disconnect electrical connector (2)		

7	Remove screws (3)		
8	Remove rear air nozzle	 Remove only the air outlet that enables access to the temperature sensor (4) of the control console (5) at the evaporator becomes accessible.	AR83.10-D-4800A
		 Before removal, check the location of the temperature sensor (4) at the evaporator through the ventilation slots of the air outlets.	
9	Remove control console (5)	 Carefully pull out temperature sensor (4) from the horizontal wall cabinet to prevent damage to the evaporator or the temperature sensor (4).	
		 Installation: Insert temperature sensor (4) again at evaporator to prevent rattling noises and inaccurate temperature control.	
10	Install in the reverse order		
11	Perform a function test	 Switch roof air conditioning on/off (see operator's manual).	

MODEL 903.662

with CODE (ZU8) National version for USA

with CODE (Z29) "James Cook" touring camper, NAFTA

Roof air conditioning refrigerant compressor

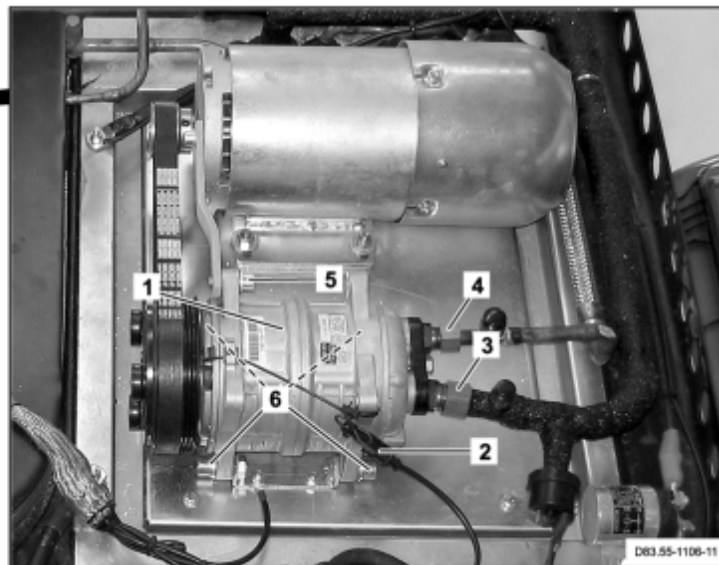

D83.55-1107-08

1 Refrigerant compressor

2 Electrical connector









3 Refrigerant line

4 Refrigerant line

5 Screw

6 Bolts

☒ ☒	Remove/Install		
⚠ Danger!	Risk of death caused by falling down from the roof of the vehicle. Risk of injury to other persons caused by falling objects during work in the area of the roof.	Work on or in the area of the vehicle's roof may only be performed on suitable equipment (ladders, scaffolds, lifting platforms). Sufficiently secure the area to be worked in.	AS65.00-Z-0002-01B
⚠ Danger!	Risk of explosion from welding or soldering work on closed air conditioning system. Risk of poisoning from inhaling overheated refrigerant vapors. Risk of injury to skin and eyes caused by contact with liquid refrigerant.	Never perform welding work on or near a closed air conditioning system. No smoking or open flames. Wear safety glasses and protective gloves. Work only in well ventilated areas. Carry out repair work on the air conditioning system circuit only after the system has been discharged.	AS83.00-Z-0001-01A
⚠ Danger!	Risk of injury caused by exiting refrigerant and by contact with	Wear protective clothing, safety gloves and safety glasses	AS86.61-Z-0002-01A

	the components of the refrigerant system		
 Danger!	Risk of death from coming into contact with electrical parts of the 110 V system. Risk of injury caused by burns, which can be produced by electrical shocks or by body parts coming in direct contact with electrical currents.	Do not touch any conductive parts of the 110 V system.	AS00.00-Z-0027-01A
	Protect air conditioning circuit and components from moisture when carrying out repair work	Type 903.662	AH83.30-N-0005-01C
	Notes on handling refrigerant R134a	Type 903.662	AH83.30-N-0003-01B
1	Switch off roof air conditioning	 See Operator's Manual	
2	Disconnect external 110 V feed line from the vehicle	 See Operator's Manual	
3	Remove web-type fuse	Of the roof air conditioning in the engine compartment	AR54.15-D-2100B
4	Drain roof air conditioning	Roof air conditioning made by Kerstner, model 103K	AR83.30-D-1760C
5	Remove V-belt of refrigerant compressor (1)		AR83.65-D-2060B
6	Disconnect electrical connector (2)		
7	Unscrew refrigerant line (3) from refrigerant compressor (1)	 Installation: Replace O-ring of refrigerant line (3).	
8	Unscrew refrigerant line (4) from refrigerant compressor (1)	 Installation: Replace O-ring of refrigerant line (4).	
9	Remove bolt (5).		
10	Unscrew bolts (6)		
11	Remove refrigerant compressor (1)	 If the refrigerant compressor (1) needs to be replaced due to an internal defect, then replace the entire roof air conditioning. See ↓	
		Detach/attach roof air conditioning on vehicle roof	AR83.30-D-1000A
		 Installation: Determine the remaining oil quantity in the removed refrigerant compressor (1) using a measuring cup. Drain	

		refrigerant compressor (1) to be installed and fill with new compressor oil (measured oil quantity of removed refrigerant compressor (1)).	
12	Install in the reverse order		
13	Evacuate roof air conditioning, refill, check for leaks and for proper operation	Roof air conditioning made by Kerstner, model 103K	AR83.30-D-1760C

MODEL 903.662

with CODE (ZU8) National version for USA

with CODE (Z29) "James Cook" touring camper, NAFTA

Refrigerant compressor of roof air conditioning

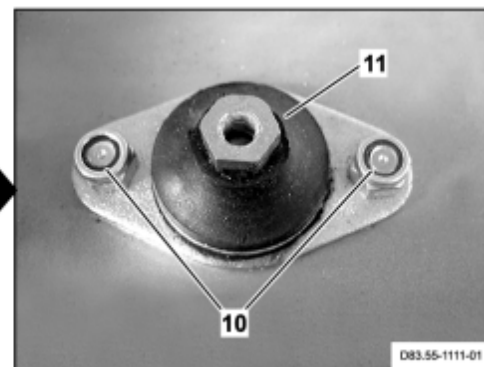
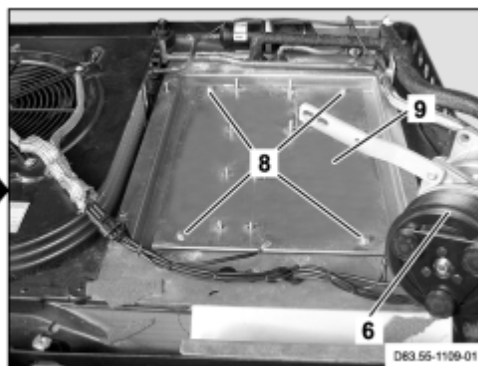
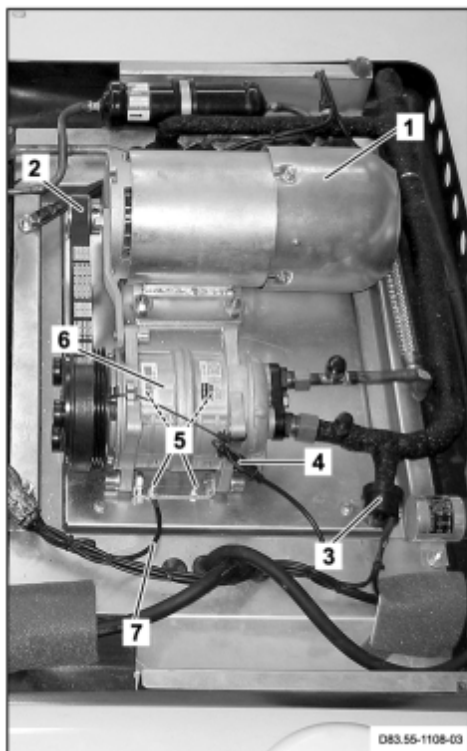



D83.55-1112-09

1 Motor
2 V-belt
3 Low pressure switch
4 Electrical connector

5 Nuts
6 Refrigerant compressor
7 Ground cable
8 Bolts

9 Carrier plate
10 Nuts
11 Vibration damper

	Remove/Install		
Danger!	Risk of death caused by falling from vehicle roof. Risk of injury to other persons caused by falling objects during work in roof area.	Perform works on or in the area of the vehicle roof only on suitable auxiliary implements (ladders, scaffolding, assembly platforms). Secure working area adequately.	AS65.00-Z-0002-01B
Danger!	Risk of injury through leaking refrigerant and through contact with components of the refrigerant system	Wear protective clothing, safety gloves and safety glasses	AS86.61-Z-0002-01A
	Notes on self-locking nuts and	All models	AH00.00-N-0001-

	bolts		01A
1	Switch off roof air conditioning	 See Operating Instructions	
2	Remove web-type fuse	Of roof air conditioning in engine compartment	AR54.15-D-2100B
3	Remove cover of roof air conditioning on vehicle roof		AR83.30-D-1010A
4	Remove motor (1)	Motor of roof air conditioning refrigerant compressor	AR83.65-D-2070B
5	Remove V-belt (2) of the refrigerant compressor (6)		
6	Detach electrical connector from low pressure switch (3)		
7	Disconnect electrical connector (4)		
8	Unscrew nuts (5).		
9	Remove ground line (7)		
10	Unscrew bolts (8) from carrier plate (9)		
11	Remove carrier plate (9)	 To do this, slightly lift up refrigerant compressor (6). Refrigerant compressor (6) does not have to be disconnected from refrigerant system (flexible refrigerant lines).	
12	Unscrew nuts (10)		
13	Remove vibration damper (11)		
14	Install in the reverse order		

MODEL 903.662

with CODE (ZU8) National version for USA

with CODE (Z29) "James Cook" touring camper, NAFTA

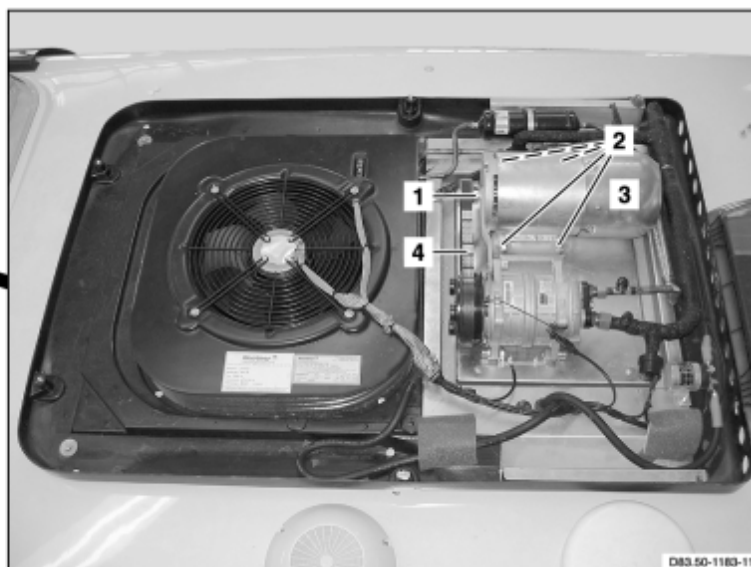





D83.50-1184-08

1 Screw
2 Nuts

3 Drive motor

4 V-belt

☒ ☒	Remove/Install		
⚠ Danger!	Risk of death from coming into contact with electrical parts of the 110 V system. Risk of injury caused by burns, which can be produced by electrical shocks or by body parts coming in direct contact with electrical currents.	Do not touch any conductive parts of the 110 V system.	AS00.00-Z-0027-01A
⚠ Danger!	Risk of death caused by falling down from the roof of the vehicle. Risk of injury to other persons caused by falling objects during work in the area of the roof.	Work on or in the area of the vehicle's roof may only be performed on suitable equipment (ladders, scaffolds, lifting platforms). Sufficiently secure the area to be worked in.	AS65.00-Z-0002-01B
⚠ Danger!	Risk of injury caused by exiting refrigerant and by contact with the components of the refrigerant system	Wear protective clothing, safety gloves and safety glasses	AS86.61-Z-0002-01A
1	Switch off roof air conditioning	i See Operator's Manual	

2	Disconnect external 110 V feed line from the vehicle	 See Operator's Manual	
3	Remove web-type fuse	Of the roof air conditioning in the engine compartment	AR54.15-D-2100B
4	Remove cover for roof air conditioning on vehicle roof		AR83.30-D-1010A
5	Loosen bolt (1) of tensioning rail		
6	Loosen nuts (2) of drive motor (3)	 Installation: Align drive motor (3) parallel to the refrigerant compressor, otherwise the V-belt (4) may jump off the V-belt pulley during operation.	
7	Release tension in V-belt (4) of refrigerant compressor	 By moving the drive motor (3).	
8	Remove V-belt (4)		
9	Install in the reverse order		
10	Perform a function test	 Switch roof air conditioning on and off (see operator's manual).	

MODEL 903.662

with CODE (ZU8) National version for USA

with CODE (Z29) "James Cook" touring camper, NAFTA

Roof air conditioning refrigerant compressor motor

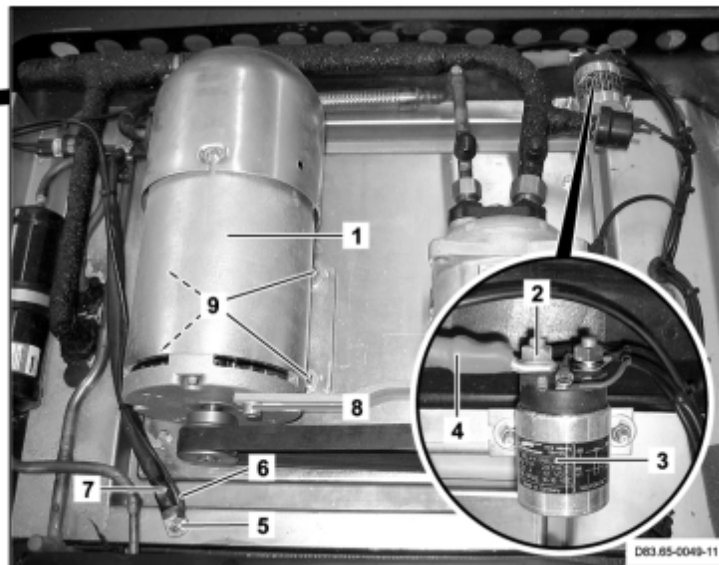







D83.65-0050-08

1 Motor
2 Nut
3 Load relay

4 Electrical line
5 Nut
6 Electrical line

7 Electrical line
8 Screw
9 Nuts

☒ ☒	Remove/Install		
⚠ Danger!	Risk of death caused by falling down from the roof of the vehicle. Risk of injury to other persons caused by falling objects during work in the area of the roof.	Work on or in the area of the vehicle's roof may only be performed on suitable equipment (ladders, scaffolds, lifting platforms). Sufficiently secure the area to be worked in.	AS65.00-Z-0002-01B
⚠ Danger!	Risk of injury caused by exiting refrigerant and by contact with the components of the refrigerant system	Wear protective clothing, safety gloves and safety glasses	AS86.61-Z-0002-01A
⚠ Danger!	Risk of death from coming into contact with electrical parts of the 110 V system. Risk of injury caused by burns, which can be produced by electrical shocks or by body parts coming in direct contact with electrical currents.	Do not touch any conductive parts of the 110 V system.	AS00.00-Z-0027-01A

	Notes on self-locking nuts and bolts	All models	AH00.00-N-0001-01A
1	Switch off roof air conditioning	 See Operator's Manual	
2	Disconnect external 110 V feed line from the vehicle	 See Operator's Manual	
3	Remove web-type fuse	Of the roof air conditioning in the engine compartment	AR54.15-D-2100B
4	Remove V-belt of refrigerant compressor		AR83.65-D-2060B
5	Unscrew nut (2) at load relay (3)		
6	Detach electrical line (4) from load relay (3)		
7	Detach all tie straps from electrical line (4)		
8	Unscrew nut (5)		
9	Detach electrical lines (6, 7) from contact pin		
10	Detach all tie straps from electrical line (7)		
11	Remove screw (8)		
12	Unscrew nuts (9)	 Installation: Replace self-locking nuts (9).	
13	Remove motor (1)	 Installation: Align motor (1) parallel to the refrigerant compressor.	
14	Install in the reverse order		
15	Perform a function test	 Switch roof air conditioning on and off (see operator's manual).	

MODEL 903.662

with CODE (ZU8) National version for USA

with CODE (Z29) "James Cook" touring camper, NAFTA

Kitchen block air outlet

1 Garbage bag holder



D86.30-0056-05

2 Bolts

3 Panel

4 Floor panel

5 Hose clamp

6 Hose

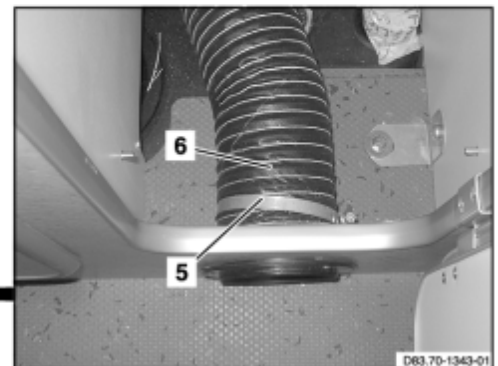
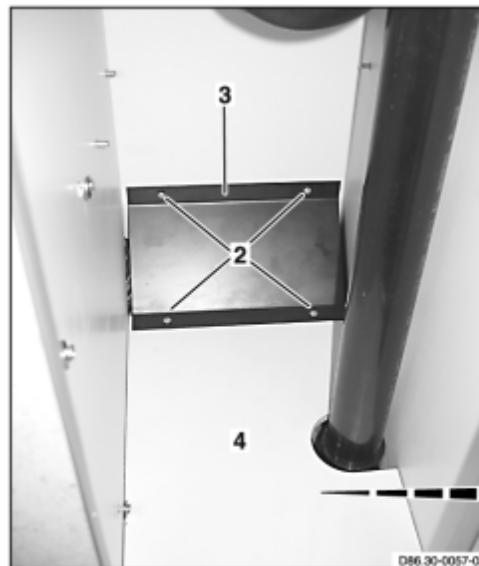

D83.70-1342-05

7 Ventilation grille

8 Bolts

9 Air nozzle

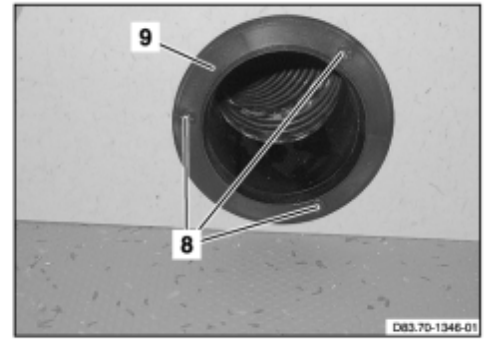
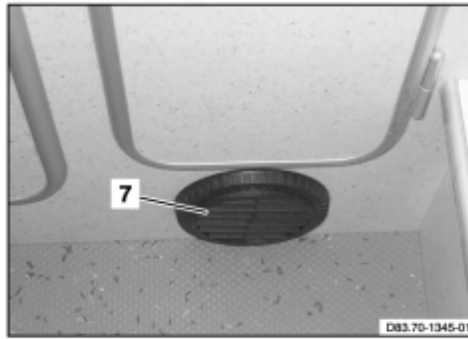

D83.70-1344-04

	Remove/Install		
⚠ Danger!	Risk of injury caused by scraping or cutting body parts on sharp vehicle parts	Always wear protective gloves when working on or near sharp and undeurred vehicle parts. Deburr replacement panels.	AS00.00-Z-0017-01B
1	Detach garbage bag holder (1) and remove		
2	Unscrew bolts (2)		
3	Remove sheet metal (3)		
4	Remove floor panel (4)		
5	Loosen hose clamp (5)		
6	Pull off hose (6)		
7	Unclip and take off the ventilation grille (7)	Mounting wedge	110 589 03 59 00
8	Unscrew bolts (8).		
9	Remove air outlet (9)		
10	Install in the reverse order		



110 589 03 59 00

Mounting wedge

MODEL 903.662

with CODE (ZU8) National version for USA

with CODE (Z29) "James Cook" touring camper, NAFTA

Air outlet for seating

1 Ventilation grille

2 Bolts

3 Air nozzle

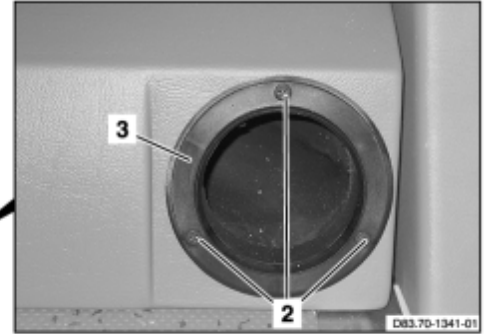
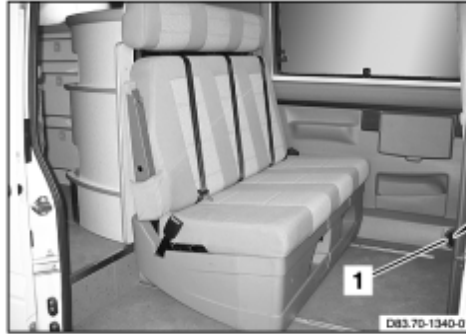

D83.70-1339-04

☒ ☒	Remove/Install	☒ Mounting wedge	110.589.03.59.00
1	Unclip and take off the ventilation grille (1)		
2	Unscrew bolts (2)		
3	Remove air outlet (3)		
4	Install in the reverse order		



110 589 03 59 00

Mounting wedge

MODEL 903.662

with CODE (ZU8) National version for USA

with CODE (Z29) "James Cook" touring camper, NAFTA

- 1 Clamps
- 2 Fuel lines
- 3 Electrical connector
- 4 Fuel metering pump
- 5 Rubber holder

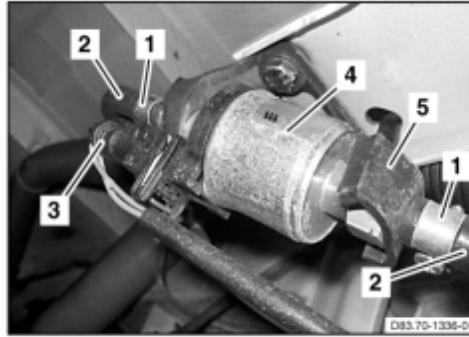

D83.70-1337-04

	Remove/Install		
Danger!	Risk of death caused by vehicle slipping or toppling off of the lifting platform.	Align vehicle between the columns of the lifting platform and position the four support plates at the lifting platform support points specified by the vehicle manufacturer.	AS00.00-Z-0010-01A
Danger!	Risk of explosion caused by fuel igniting, risk of poisoning caused by inhaling and swallowing fuel as well as risk of injury to eyes and skin caused by contact with fuel.	No fire, sparks, open flames or smoking. Pour fuels only into suitable and appropriately marked containers. Wear protective clothing when handling fuel.	AS47.00-Z-0001-01A
Danger!	Risk of explosion caused by fuel vapors igniting, risk of poisoning caused by inhaling combustible gases and risk of injury caused by burns during and after operation of heater unit	Do not operate stationary heater, auxiliary heater or engine with heater booster in closed areas or when refueling. Allow heater unit to cool down after operation and wear protective gloves.	AS83.70-Z-0002-01A
1	Loosen clamps (1)		AR83.70-D-5945A
2	Detach fuel lines (2)	Catch escaping fuel in a suitable container; plug the fuel lines (2).	
		Set of plugs	129 589 00 91 00
3	Disconnect electrical connector		

	(3)		
4	Unhook fuel metering pump (4) from rubber mount (5) and remove		
5	Install in the reverse order		
6	Operational check	i Check heating effect.	

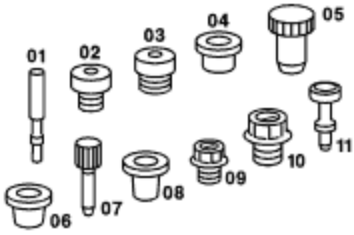

129 589 00 91 00

Set of stop plugs

MODEL 903.662

with CODE (ZU8) National version for USA

with CODE (Z29) "James Cook" touring camper, NAFTA

- 1 Bolts
- 2 Cover
- 3 Retaining ring
- 4 Cover
- 5 Screw
- 6 Auxiliary heating control unit
- 7 Electrical connector
- 8 Rubber seal
- 9 Glow plug

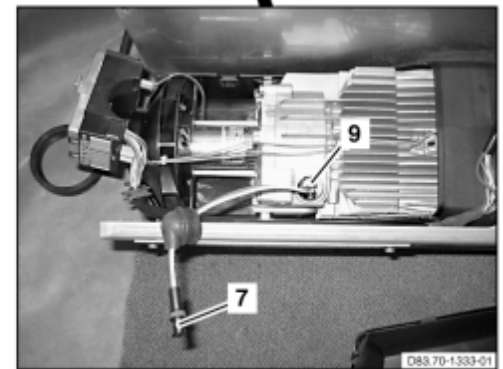
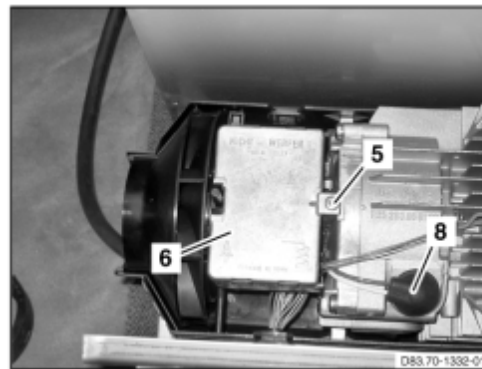
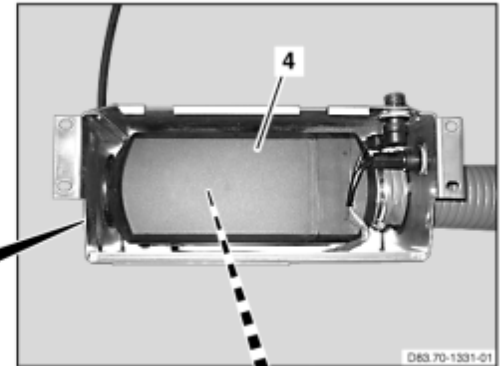
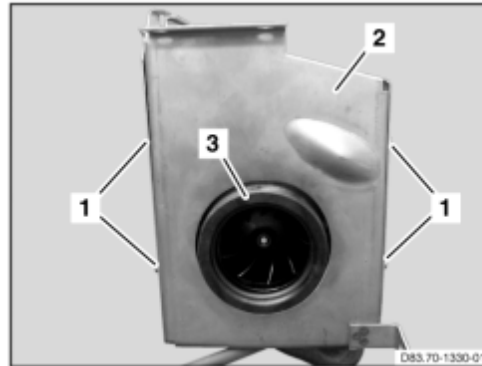

D83.70-1329-06

☒ ☒	Remove/Install		
⚠ Danger!	Risk of death caused by vehicle slipping or toppling off of the lifting platform.	Align vehicle between the columns of the lifting platform and position the four support plates at the lifting platform support points specified by the vehicle manufacturer.	AS00.00-Z-0010-01A
⚠ Danger!	Risk of injury caused by scraping or cutting body parts on sharp vehicle parts	Always wear protective gloves when working on or near sharp and non-deburred vehicle parts. Deburr repair panels.	AS00.00-Z-0017-01B
⚠ Danger!	Risk of explosion caused by fuel igniting, risk of poisoning caused by inhaling and swallowing fuel as well as risk of injury to eyes and skin caused by contact with fuel.	No fire, sparks, open flames or smoking. Pour fuels only into suitable and appropriately marked containers. Wear protective clothing when handling fuel.	AS47.00-Z-0001-01A

<p>⚠ Danger!</p>	<p>Risk of explosion caused by fuel vapors igniting, risk of poisoning caused by inhaling combustible gases and risk of injury caused by burns during and after operation of heater unit</p>	<p>Do not operate stationary heater, auxiliary heater or engine with heater booster in closed areas or when refueling. Allow heater unit to cool down after operation and wear protective gloves.</p>	<p>AS83.70-Z-0002-01A</p>
1	Remove auxiliary heater		<p>AR83.70-D-5945A</p>
2	Remove bolts (1)		
3	Take off cover (2)		
4	Detach retaining ring (3)		
5	Release and remove cover (4)		
6	Remove bolt (5)		
7	Release auxiliary heater control unit (6) and pull out		
8	Unplug electrical connector (7)		
9	Detach sealing rubber (8) from opening of glow plug (9)	<p>i Installation: Check sealing rubber (8), replace if necessary.</p>	
10	Unscrew glow plug (9)	<p>i Glow plug (9) can only be unscrewed using special wrench. Special wrench is supplied with new glow plug (9).</p>	
11	Install in the reverse order		
12	Perform a function test	<p>i Check heating effect.</p>	

MODEL 903.662

with CODE (ZU8) National version for USA

with CODE (Z29) "James Cook" touring camper, NAFTA

- 1 Bolts
- 2 Cover
- 3 Retaining ring
- 4 Cover
- 5 Screw
- 6 Auxiliary heating control unit
- 7 Bayonet locks

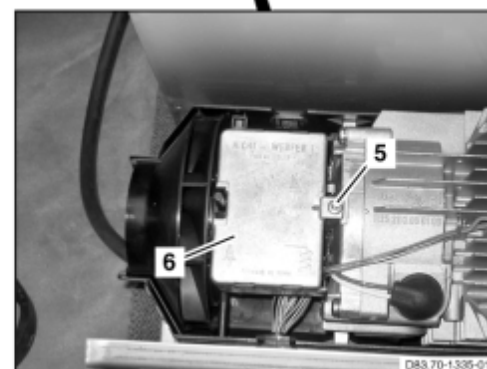
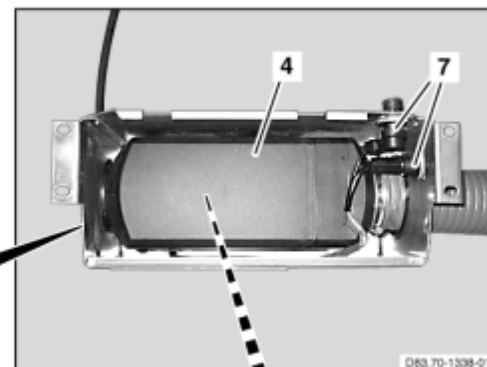
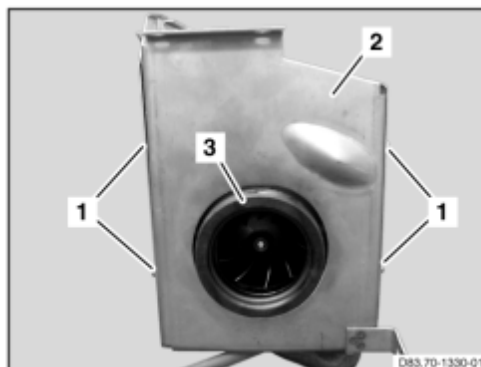

D83.70-1334-06

☒ ☒	Remove/Install		
⚠ Danger!	Risk of injury caused by scraping or cutting body parts on sharp vehicle parts	Always wear protective gloves when working on or near sharp and non-deburred vehicle parts. Deburr repair panels.	AS00.00-Z-0017-01B
1	Remove auxiliary heater		AR83.70-D-5945A
2	Remove bolts (1)		
3	Take off cover (2)		
4	Detach retaining ring (3)		
5	Release and remove cover (4)		
6	Remove bolt (5).		
7	Release auxiliary heater control unit (6) and pull out		
8	Unplug electrical connectors		

	from auxiliary heater control unit (6)		
9	Open bayonet locks (7) and remove inward		
10	Remove auxiliary heater control unit (6)		
11	Install in the reverse order		

MODEL 903.662

with CODE (ZU8) National version for USA

with CODE (Z29) "James Cook" touring camper, NAFTA

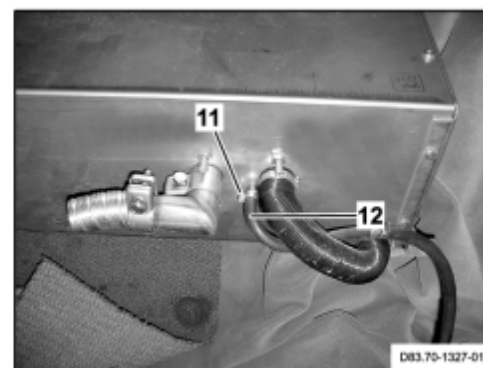
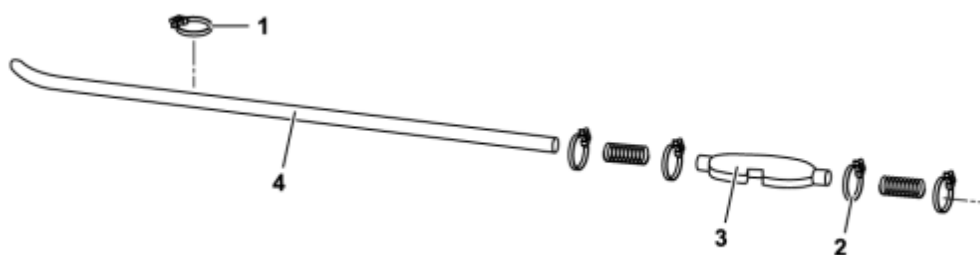
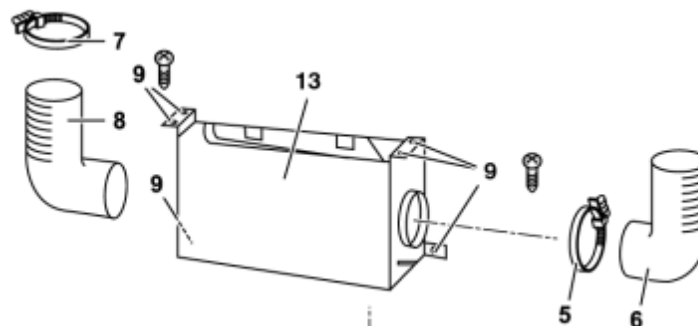

D83.70-1325-09

1 Clip
2 Clip
3 Exhaust muffler
4 Exhaust pipe
5 Clip

6 Inlet air hose
7 Clip
8 Preheating hose
9 Bolts
10 Clutches

11 Clip
12 Fuel pipe
13 Auxiliary heater

☒ ☒	Remove/Install		
⚠ Danger!	Risk of death caused by vehicle slipping or toppling off of the lifting platform.	Align vehicle between the columns of the lifting platform and position the four support plates at the lifting platform support points specified by the vehicle manufacturer.	AS00.00-Z-0010-01A
⚠ Danger!	Risk of injury caused by scraping or cutting body parts on sharp vehicle parts	Always wear protective gloves when working on or near sharp and non-deburred vehicle parts. Deburr repair panels.	AS00.00-Z-0017-01B
⚠ Danger!	Risk of explosion caused by	No fire, sparks, open flames or	AS47.00-Z-0001-

	fuel igniting, risk of poisoning caused by inhaling and swallowing fuel as well as risk of injury to eyes and skin caused by contact with fuel.	smoking. Pour fuels only into suitable and appropriately marked containers. Wear protective clothing when handling fuel.	01A
⚠ Danger!	Risk of explosion caused by fuel vapors igniting, risk of poisoning caused by inhaling combustible gases and risk of injury caused by burns during and after operation of heater unit	Do not operate stationary heater, auxiliary heater or engine with heater booster in closed areas or when refueling. Allow heater unit to cool down after operation and wear protective gloves.	AS83.70-Z-0002-01A
1	Slacken clamp (1)		
2	Slacken clamp (2)		
3	Detach exhaust muffler (3)		
4	Slide exhaust pipe (4) with exhaust muffler (3) to the rear		
5	Undo clamp (5) at inlet air hose (6)		
6	Detach inlet air hose (6)		
7	Undo clamp (7) at preheating hose (8)		
8	Pull off preheating hose (8)		
9	Unscrew screws (9)		
10	Remove auxiliary heater (13)		
11	Unlock and unplug connectors (10)		
12	Remove clamp (11) at fuel line (12)	i Installation: Install new clamp (11).	
13	Detach fuel line (12)	i Catch the fuel that leaking in a suitable container; plug the fuel line (12).	
		🔧 Set of plugs	129 589 00 91 00
14	Install in the reverse order		
15	Perform a function test	i Check function of auxiliary heater (13)	

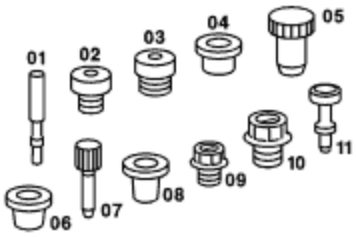

129 589 00 91 00

Set of stop plugs

MODEL 903.662

with CODE (ZU8) National version for USA

with CODE (Z29) "James Cook" touring camper, NAFTA

1 Temperature sensor

D83.70-1324-12

☒ ☒	Remove/Install		
1	Unclip the temperature sensor (1)	☒ Long wedge	115 589 03 59 00
2	Unplug connector from temperature sensor (1)		
3	Remove temperature sensor (1)		
4	Install in the reverse order		



115 589 03 59 00

Longitudinal wedge

MODEL 903.662

with CODE (ZU8) National version for USA

with CODE (Z29) "James Cook" touring camper, NAFTA

1 Clip

2 Clip

3 Exhaust line

4 Auxiliary heater

5 Exhaust system

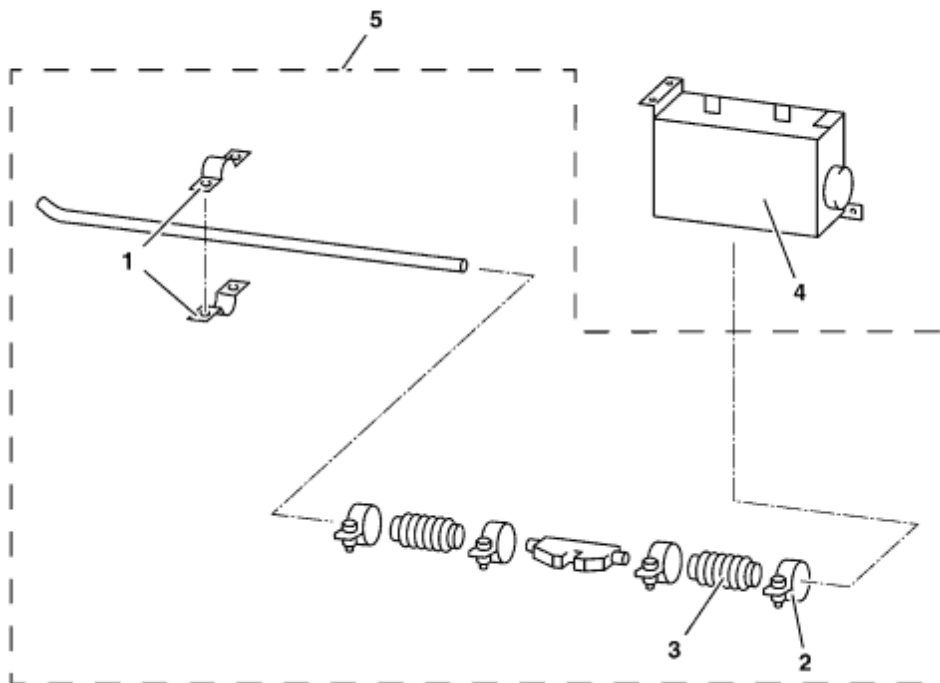

D83.70-1328-06

☒ ☒	Remove/Install		
⚠ Danger!	Risk of injury to skin and eyes from handling hot or glowing objects. Risk of fire caused by contact of glowing objects with flammable materials.	Wear safety gloves, protective clothing and safety glasses, if necessary. Avoid contact between glowing objects and flammable materials.	AS00.00-Z-0026-01A
⚠ Danger!	Risk of explosion caused by fuel vapors igniting, risk of poisoning caused by inhaling combustible gases and risk of injury caused by burns during and after operation of heater unit	Do not operate stationary heater, auxiliary heater or engine with heater booster in closed areas or when refueling. Allow heater unit to cool down after operation and wear protective gloves.	AS83.70-Z-0002-01A
1	Open clamp (1)		
2	Slacken clamp (2)		
3	Pull off exhaust line (3) from auxiliary heater (4)		
4	Remove exhaust system (5)		

5	Install in the reverse order		
---	------------------------------	--	--

MODEL 903.662

with CODE (ZU8) National version for USA

with CODE (Z29) "James Cook" touring camper, NAFTA

1 City water connection

2 Bolts

3 Hose clamp

4 Hose

5 Connection

6 Electrical connector

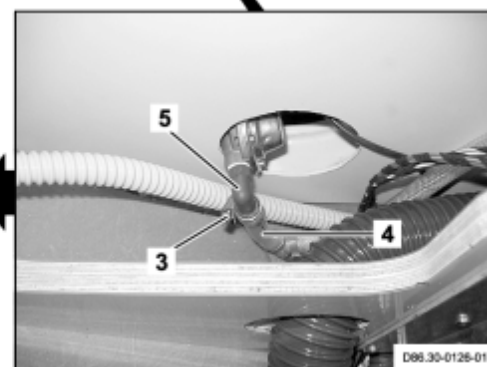

D86.30-0127-06

☒ ☒	Remove/Install		
⚠ Danger!	Risk of injury caused by scraping or cutting body parts on sharp vehicle parts	Always wear protective gloves when working on or near sharp and undeurred vehicle parts. Deburr replacement panels.	AS00.00-Z-0017-01B
⚠ Danger!	Explosion hazard by ignition of methane gas leaking from components in excrement tank and sewage system. Injury hazard by burning of skin and eyes through inhalation or skin contact with excrements.	Wear protective gloves, safety glasses and respiratory mask. Before starting work, ensure that all ignition sources are eliminated and that the excrement tank is completely emptied.	AS86.00-Z-0003-01A
1	Disconnect external support of city water connection (1)	i See Operating Instructions	
2	Unscrew bolts (2)		
3	Remove excrement tank		AR86.30-D-0073A

4	Loosen hose clamp (3) on connection (5) of pressure reducing valve (5)		
5	Remove hose (5) from pressure reducing valve (5)		
6	Disconnect electrical connector (6)		
7	Remove city water connection (1)		
8	Install in the reverse order		
9	Check fresh water system for leakage		AR86.30-D-0065A

MODEL 903.662

with CODE (ZU8) National version for USA

with CODE (Z29) "James Cook" touring camper, NAFTA

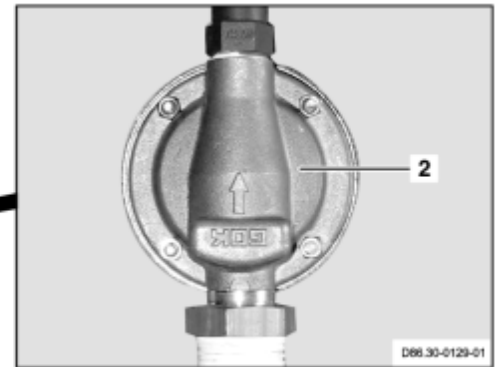
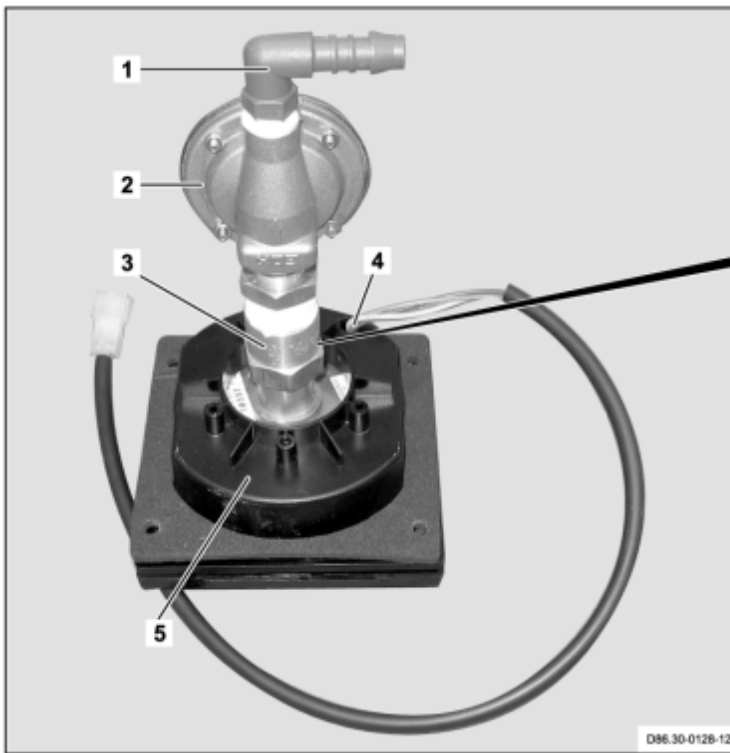

D86.30-0130-09

1 Angled piece

2 Pressure reducing valve

3 Check valve

	Remove/Install		
1	Remove city water connection		AR86.30-D-0040A
2	Unscrew angled piece (1) from pressure reducing valve (2)	i Installation: Use suitable thread sealant	
3	Unscrew pressure reducing valve (2) from check valve (3)	i Installation: Observe installation direction of pressure reducing valve (2) (arrow on component)	
		i Installation: Use suitable thread sealant.	
4	Install in the reverse order		
5	Check fresh water system for leakage		AR86.30-D-0065A

MODEL 903.662

with CODE (ZU8) National version for USA

with CODE (Z29) "James Cook" touring camper, NAFTA

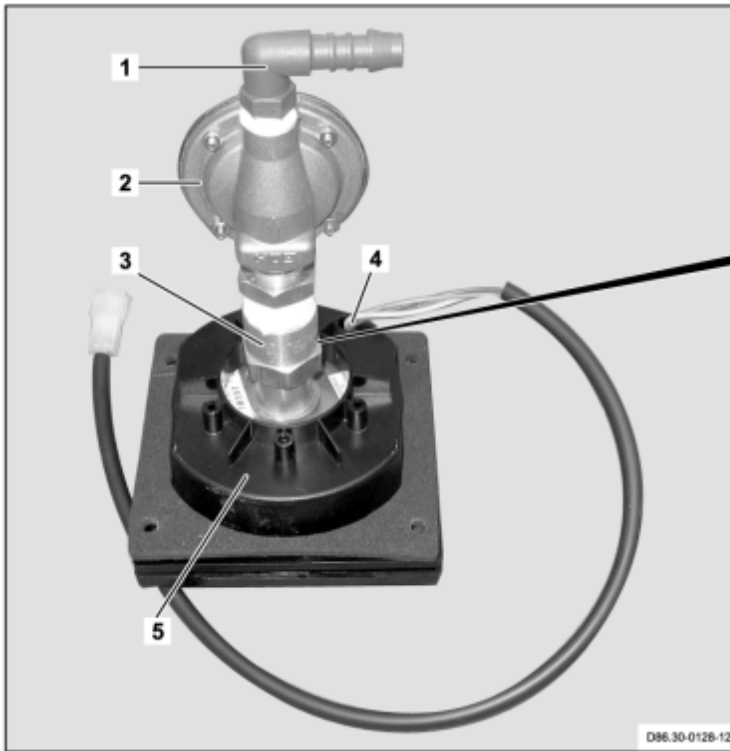

D86.30-0131-09

2 Pressure reducing valve

3 Check valve

5 Housing

☒ ☒	Remove/Install		
1	Remove city water connection		AR86.30-D-0040A
2	Remove city water connection pressure reducing valve		AR86.30-D-0041A
3	Unscrew check valve (3) from housing (5) city water connection	i Installation: Observe installation position of check valve (3) (arrow on component)	
		i Installation: Use suitable thread sealant	
4	Install in the reverse order		
5	Check fresh water system for leakage		AR86.30-D-0065A

MODEL 903.662

with CODE (ZU8) National version for USA

with CODE (Z29) "James Cook" touring camper, NAFTA

4 Contact switch
5 Housing

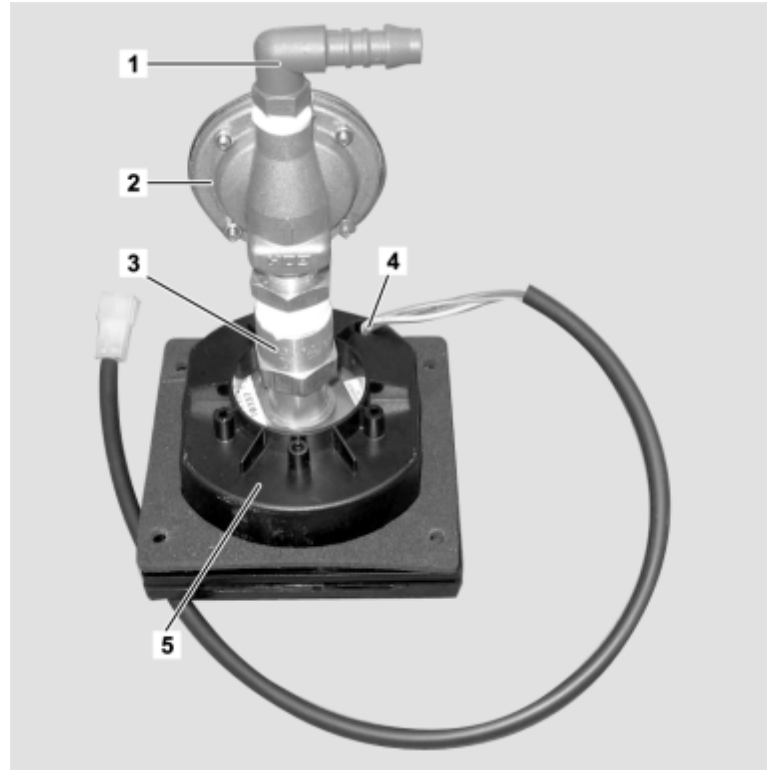

D86.30-0128-12

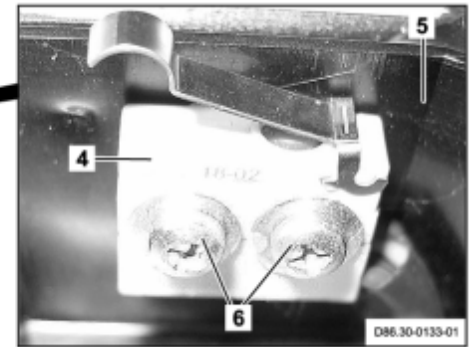

D86.30-0134-07

4 Contact switch

5 Housing

6 Bolts

	Remove/Install		
1	Remove city water connection		AR86.30-D-0040A
2	Remove plug housing from contact switch (4)		

3	Unscrew bolts (6)		
4	Remove contact switch (4) from housing (5)		
5	Install in the reverse order		
6	Check fresh water system for leakage		AR86.30-D-0065A
7	Perform a function test	i Ensure that pump in the fresh water tank does not start up when the cover on the city water connection is open.	

MODEL 903.662

with CODE (ZU8) National version for USA

with CODE (Z29) "James Cook" touring camper, NAFTA

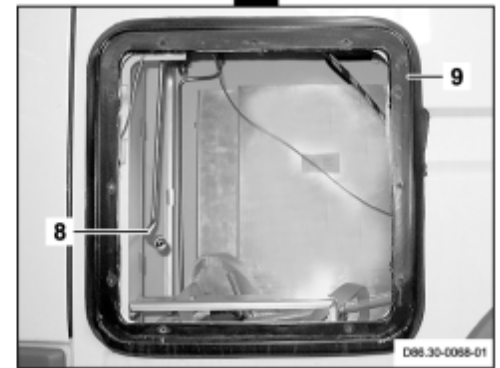
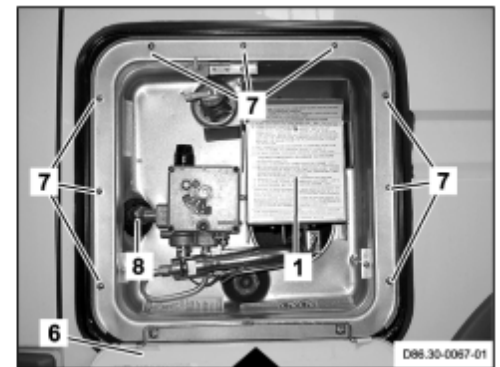
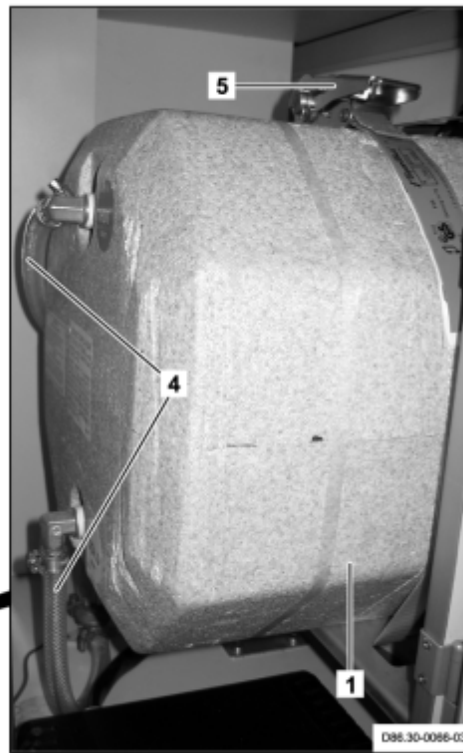
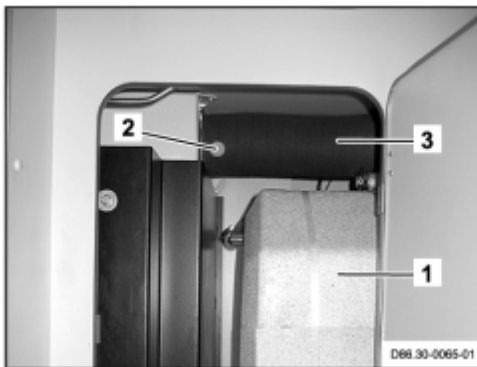









D86.30-0069-09

1 Hot water boiler
2 Screw
3 Bleed hose

4 Water lines
5 Tensioning strap
6 Outside flap

7 Bolts
8 Gas line
9 Cover frame

☒ ☒	Remove/Install		
⚠ Danger!	Risk of injury caused by scraping or cutting body parts on sharp vehicle parts	Always wear protective gloves when working on or near sharp and non-deburred vehicle parts. Deburr repair panels.	AS00.00-Z-0017-01B
⚠ Danger!	Risk of injury caused by body parts becoming jammed, pinched or severed by doors, covers, flaps or by loose components	Keep body parts well clear when moving doors, covers, flaps and components. Wear protective gloves and protective shoes.	AS00.00-Z-0025-01A
⚠ Danger!	Risk of injury caused by hot water exiting from the lines of the fresh water system	Shut off the water heater in a timely manner before starting repair work. Let the water in the lines and in the components of the fresh water system cool	AS86.00-Z-0002-01A

		down to room temperature.	
 Danger!	Risk of explosion caused by ignition of gas exiting the lines of the vehicle's gas system. Risk of injury caused by burns to skin and eyes.	Before commencing any work, ensure that all sources of ignition have been removed and that the gas system is completely emptied if necessary. Wear protective clothing.	AS86.00-Z-0004-01A
1	Switch off hot water boiler (1)	 See Operator's Manual	
2	Drain hot water boiler (1)		AR86.30-D-0051A
3	Close shut-off valve of gas pressure system on compressed gas reservoir	 See Operator's Manual	
4	Unscrew bolt (2).		
5	Remove bleed hose (3) from supply unit	 Only in area of hot water boiler (1).	
6	Loosen hose clamps from water lines (4)		
7	Remove water lines (4) from hot water boiler (1)	 Mark installation position of water lines (4) before removal.	
8	Loosen tensioning belt (5)		
9	Remove outside flap (6) from hot water boiler (1)		AR86.30-D-0052A
10	Unscrew bolts (7).		
11	Disconnect gas line (8) from hot water boiler (1)		
12	Remove hot water boiler (1)	 Carefully pull out sidewall to prevent damaging the insulation of the hot water boiler (1)	
		 Installation: Apply new sealing compound to rear of cover frame (9)	
13	Install in the reverse order		
14	Perform leakage test for gas system		AR86.60-D-0100A
15	Perform function check	 Switch on hot water boiler (1) and check heating capacity	
16.1	Attach safety sticker on hot water boiler (1)	 Only when replacing hot water boiler (1)	

MODEL 903.662

with CODE (ZU8) National version for USA

with CODE (Z29) "James Cook" touring camper, NAFTA

1 System drain valve



D86.30-0062-05

	Draining		
⚠ Danger!	Risk of injury caused by hot water exiting from the lines of the fresh water system	Shut off the water heater in a timely manner before starting repair work. Let the water in the lines and in the components of the fresh water system cool down to room temperature.	AS86.00-Z-0002-01A
1	Switch off hot water boiler	i See Operator's Manual	
2	Switch off main switch on fresh water tank pump in vehicle	i See Operator's Manual	
3	Open sink water tap		
4	Open system drain valve (1)	i See Operator's Manual	
	Charge		
5	Close system drain valve (1)	i See Operator's Manual	
6	Close sink water tap		
7	Switch on main switch on fresh water tank pump in vehicle	i See Operator's Manual	
8	Adjust sink water tap too "Hot"		

9	Open sink water tap	i The fresh water tank must be sufficiently filled	
		i External fresh water supply should not be connected to the vehicle; otherwise the power circuit for water pump is interrupted.	
		i Filling is completed when air no longer flows out of the sink water tap.	

MODEL 903.662

with CODE (ZU8) National version for USA



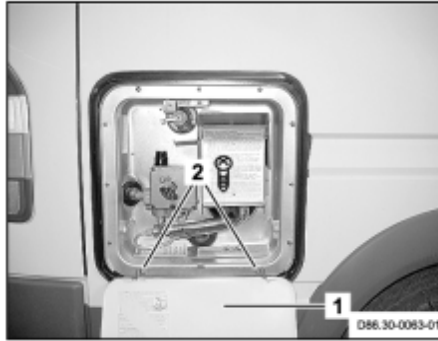

with CODE (Z29) "James Cook" touring camper, NAFTA

1 Outside flap

2 Bolts



D86.30-0064-04

	Remove/Install		
1	Switch off hot water boiler	 See Operating Instructions	
2	Open outside flap (1)		
3	Remove screws (2)	 Installation: Before tightening bolts (2) align outside flap (1) on hot water boiler	
4	Remove outside flap (1)		
5	Install in the reverse order		
6.1	Install safety sticker on outside flap (1)	 Only when replacing outside flap (1).	

MODEL 903.662

with CODE (ZU8) National version for USA

with CODE (Z29) "James Cook" touring camper, NAFTA

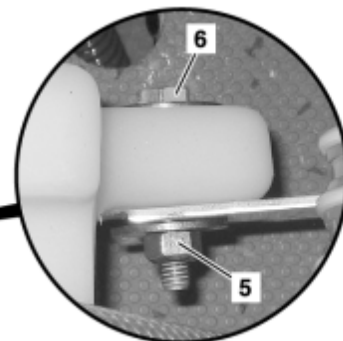
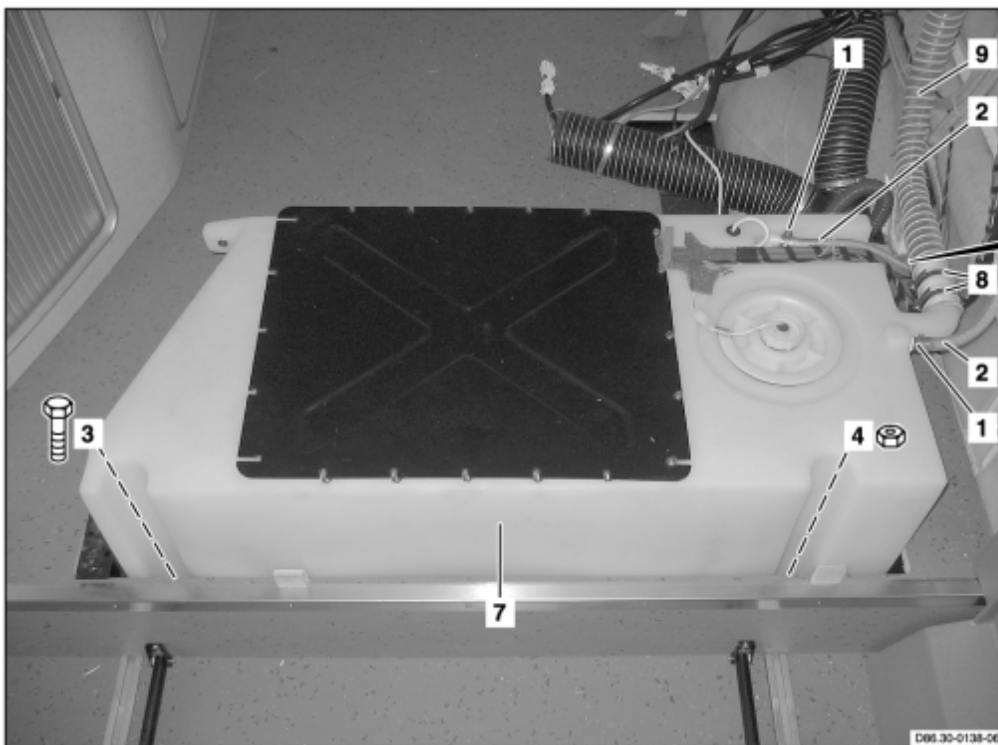

D86.30-0137-09

- 1 Hose clamp
- 2 Hose
- 3 Screw
- 4 Nut

- 5 Nut
- 6 Screw
- 7 Fresh water tank

- 8 Hose clamps
- 9 Hose

- 1 Hose clamp
- 2 Hose

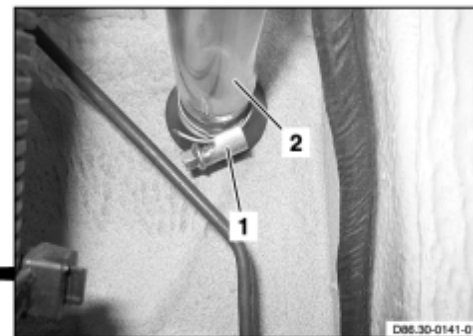

D86.30-0140-04

	<p>Remove/Install</p>		
<p>⚠ Danger!</p>	<p>Risk of injury caused by scraping or cutting body parts on</p>	<p>Always wear protective gloves when working on or near sharp</p>	<p>AS00.00-Z-0017-01B</p>

	sharp vehicle parts	and undeburred vehicle parts. Deburr replacement panels.	
1	Remove kitchen element		AR86.60-D-0001A
2	Remove additional battery.		AR54.10-D-0007A
3	Remove water level sensor for fresh water tank (7)		AR86.30-D-0061A
4	Remove water pump in fresh water tank (7)		AR86.30-D-0062A
5	Loosen all hose clamps (1)		
6	Remove all hoses (2) from fresh water tank (7)		
7	Slacken hose clamps (8)		
8	Remove filler hose (9) from fresh water tank (7)		
9	Remove bolt (3)		
10	Unscrew nut (4)		
11	Unscrew nut (5) from screw (6)		
12	Remove fresh water tank (7)		
13	Install in the reverse order		

MODEL 903.662

with CODE (ZU8) National version for USA

with CODE (Z29) "James Cook" touring camper, NAFTA

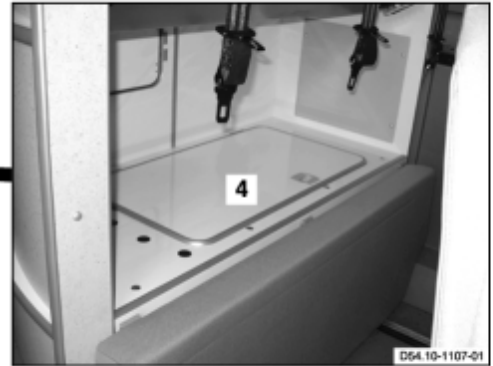
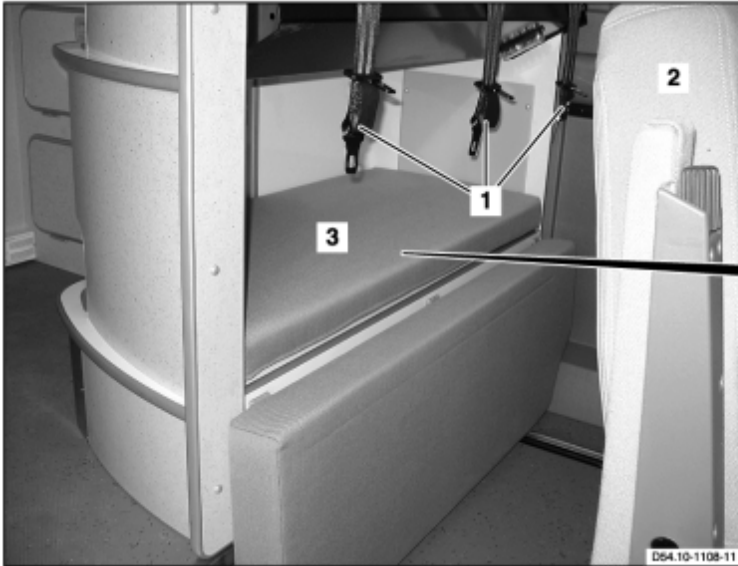

D54.10-1109-08

1 Seat belts
2 Bench seat

3 Upholstery
4 Cover

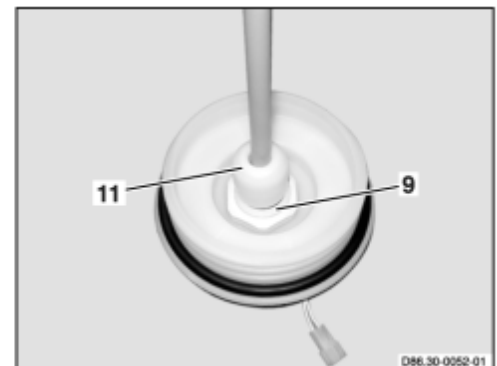
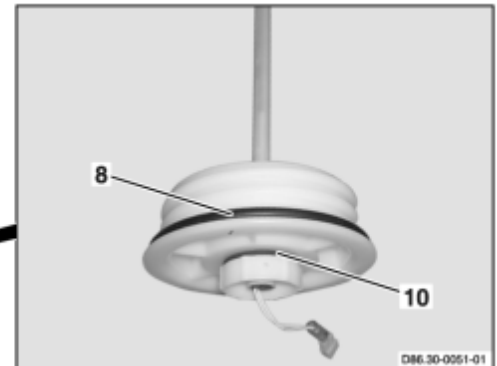
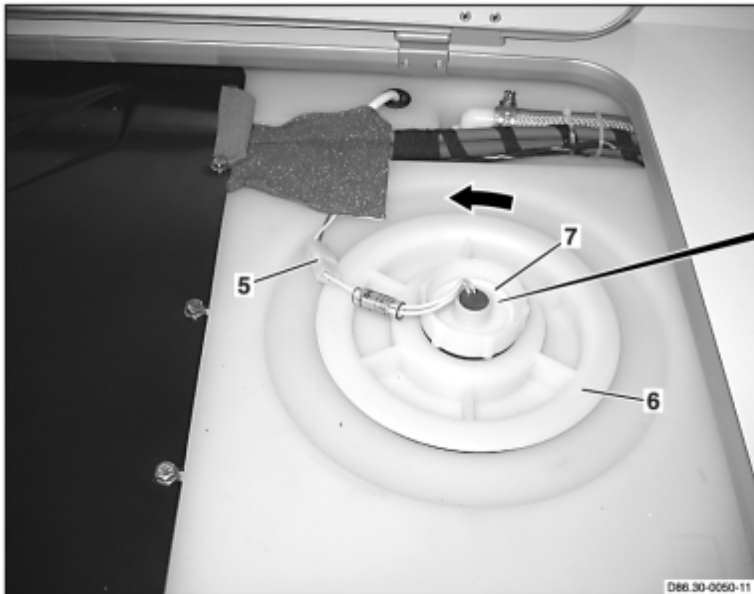





D86.30-0053-09

5 Electrical connector
 6 Cleaning cover
 7 Water level sensor

8 O-ring
 9 Nut

10 O-ring
 11 Float

	Remove/Install		
 Danger!	Risk of injury caused by body parts becoming jammed, pinched or severed by doors, covers, flaps or by loose components	Keep body parts well clear when moving doors, covers, flaps and components. Wear protective gloves and protective shoes.	AS00.00-Z-0025-01A
1	Disengage seat belts (1) from belt locks		
2	Move bench seat (2) toward front		
3	Remove upholstery (3)		
4	Fold out cover (4)		
5	Disconnect electrical connector (5)		
6	Turn cleaning cover (6) with water level sensor (7) in direction of arrow		
7	Remove cleaning cover (6) with water level sensor (7)	 Installation: Check O-ring (8) for damage, replace if necessary	
8	Unscrew nut (9)		
9	Remove water level sensor (7)	 Installation: Check O-ring (10) for damage, replace if necessary	
10	Check water level sensor (7) for proper function	 Connect water level sensor (7) with connector (5) and move float (11). Water level sensor should change in central electrical system.	
11	Install in the reverse order		

MODEL 903.662

with CODE (ZU8) National version for USA

with CODE (Z29) "James Cook" touring camper, NAFTA

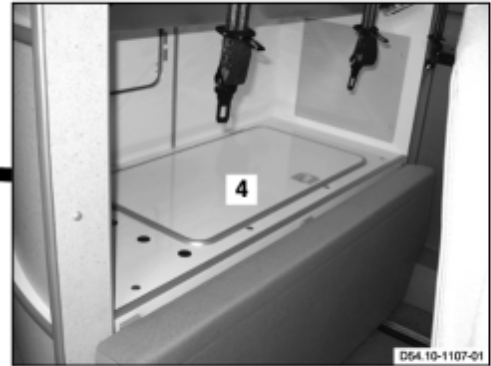
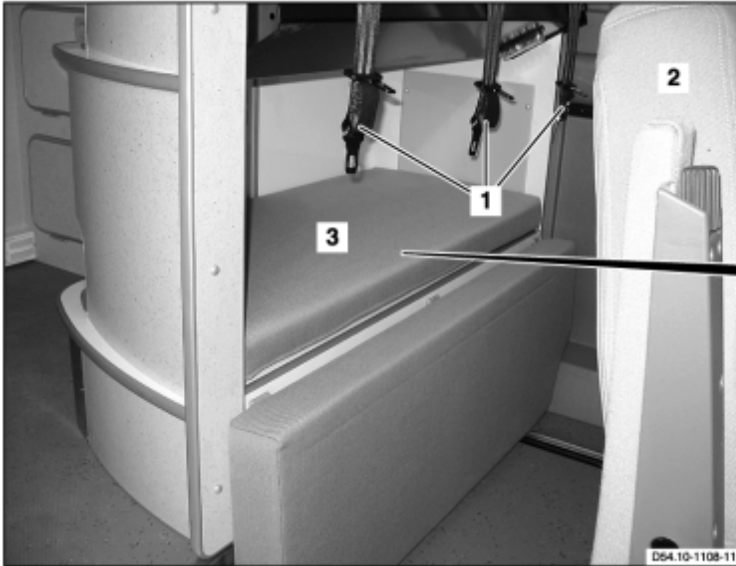

D54.10-1109-08

1 Seat belts
2 Bench seat

3 Upholstery
4 Cover

5 Plug
6 Bolts
7 Bolts
8 Cover
9 Electrical connector
10 Cleaning cover
11 Water level sensor

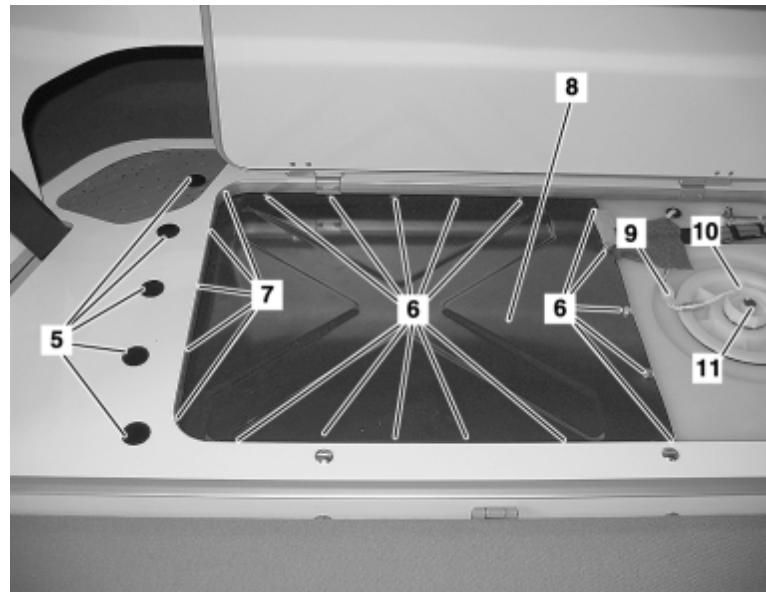

D86.30-0046-11

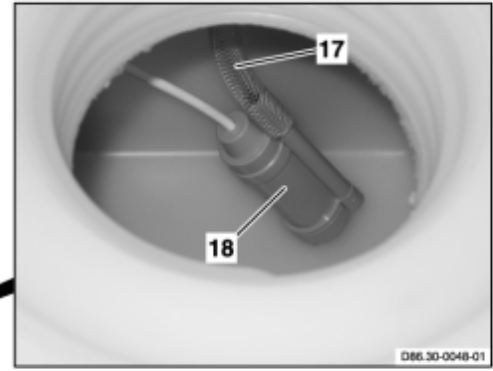
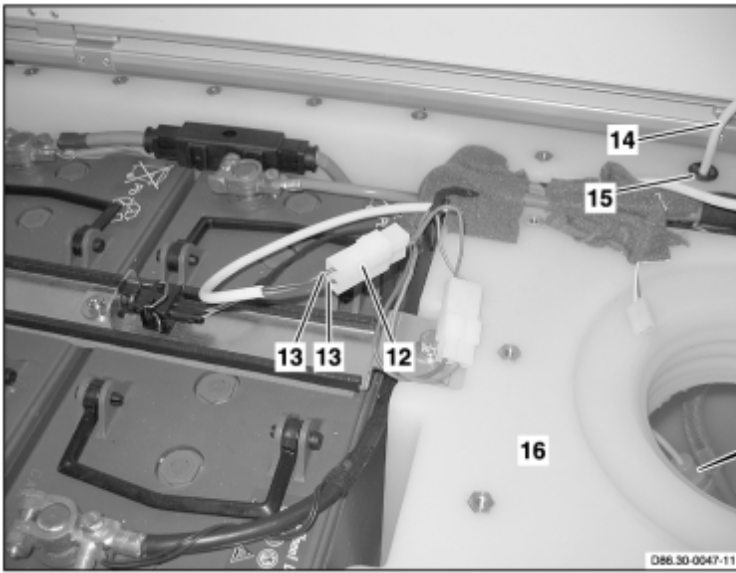

D86.30-0049-08

12 Electrical connector
 13 Electrical lines
 14 Electrical line

15 Grommet
 16 Fresh water tank

17 Hose
 18 Water pump

☒ ☒	Remove/Install		
⚠ Danger!	Risk of injury caused by body parts becoming jammed, pinched or severed by doors, covers, flaps or by loose components	Keep body parts well clear when moving doors, covers, flaps and components. Wear protective gloves and protective shoes.	AS00.00-Z-0025-01A
1	Drain fresh water tank	i See Operator's Manual	
2	Disengage seat belts (1) from belt locks		
3	Move bench seat (2) toward front		
4	Remove upholstery (3)		
5	Fold out cover (4)		
6	Remove plug (5)		
7	Remove bolts (6)		
8	Loosen bolts (7)		
9	Slide cover (8) toward right and remove		
10	Disconnect electrical connector (9)		
11	Remove cleaning cover (10) with water level sensor (11)		
12	Disconnect electrical connector (12)		

13	Unpin electrical lines (13)		
14	Install electrical line (14) with grommet (15) in fresh water tank (16)		
15	Pull off hose (17)		
16	Remove water pump (18)		
17	Install in the reverse order		
18	Check water pump (18) for proper function		

MODEL 903.662

with CODE (ZU8) National version for USA

with CODE (Z29) "James Cook" touring camper, NAFTA

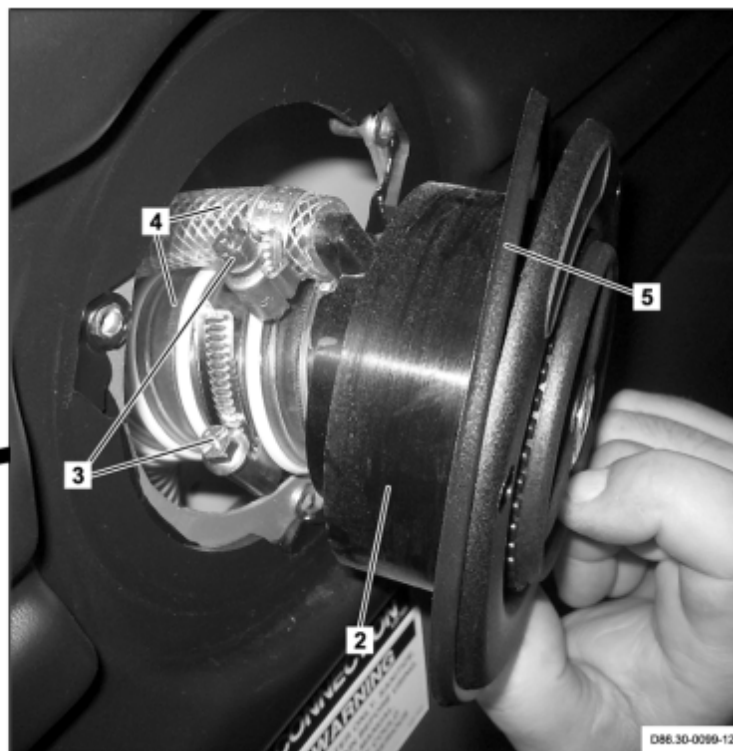

D86.30-0101-09

1 Bolts
2 Fresh water filler neck

3 Hose clamps
4 Hoses

5 Gasket

	Remove/Install		
Danger!	Risk of injury caused by scraping or cutting body parts on sharp vehicle parts	Always wear protective gloves when working on or near sharp and non-deburred vehicle parts. Deburr repair panels.	AS00.00-Z-0017-01B
1	Remove bolts (1)		
2	Pull out fresh water filler necks (2)	Until hose clamps (3) are accessible	
3	Loosen hose clamps (3)		
4	Disconnect hoses (4)		
5	Remove fresh water filler necks (2)	Installation: Check gasket (5) for damage, replace if necessary.	

MODEL 903.662

with CODE (ZU8) National version for USA

with CODE (Z29) "James Cook" touring camper, NAFTA

1 City water connection



D86.30-0110-05

☐	Check		
1	Close all water taps and valves of fresh water system	☐ See Operating Instructions	
2	Establish city water connection (1)	☐ See Operating Instructions	
		☐ Pressurize fresh water system with pressure from city water supply.	
3	Bleed fresh water system	☐ Open water taps on boiler/sink combination and in wash room until bubbles are no longer present in water flowing out.	
4	Check city water connection (1) for leakage		
5	Check fresh water system for leakage in area of boiler/sink combination		AR86.30-D-0065-01A
6	Check fresh water system for leakage in area of fresh water		AR86.30-D-0065-02A

	tank		
7	Check fresh water system for leakage in area of wash room		AR86.30-D-0065-03A
8	Check fresh water system for leakage in rear area of vehicle		AR86.30-D-0065-04A
9	Separate city water connection (1)	i See Operating Instructions	

MODEL 903.662

with CODE (ZU8) National version for USA

with CODE (Z29) "James Cook" touring camper, NAFTA

- 1 Bolts
- 2 Butyl tape
- 3 Bleeding

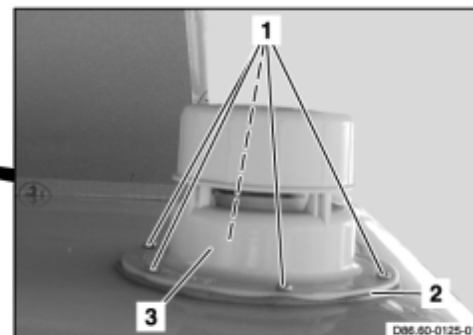

D86.30-0142-04

	Remove/Install		
Danger!	Risk of death caused by falling from vehicle roof . Risk of injury to other persons caused by falling objects during work in roof area.	Perform work on and in area of vehicle roof only with suitable aids (ladders, scaffolding, assembly platforms). Sufficiently secure working area	AS65.00-Z-0002-01B
Danger!	Explosion hazard by ignition of methane gas leaking from components in toilet and sewage system. Injury hazard by burning of skin and eyes through inhalation or skin contact with excrements.	Wear protective gloves, safety glasses and respiratory mask Before starting work, ensure that all ignition sources are eliminated and that the excrement tank is completely emptied.	AS86.00-Z-0003-01A
1	Remove screws (1)		
2	Separate butyl cord (2)	Mounting wedge	110 589 03 59 00
		Butyl tape	BR00.45-Z-1067-01A
3	Remove ventilation (3)		
4	Install in the reverse order		



110 589 03 59 00

Mounting wedge

Auxiliary repair materials

Number	Designation	Order number
BR00.45-Z-1067-01A	12 x 1.5 mm butyl strip	170 795 11 98

MODEL 903.662

with CODE (ZU8) National version for USA

with CODE (Z29) "James Cook" touring camper, NAFTA

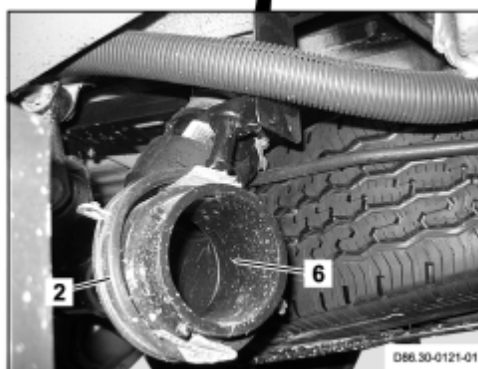
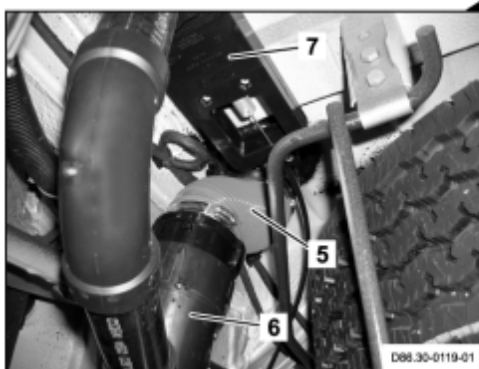
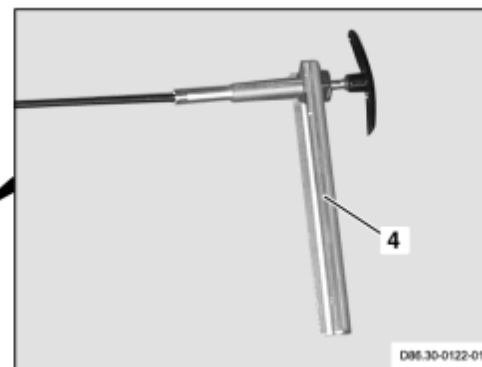
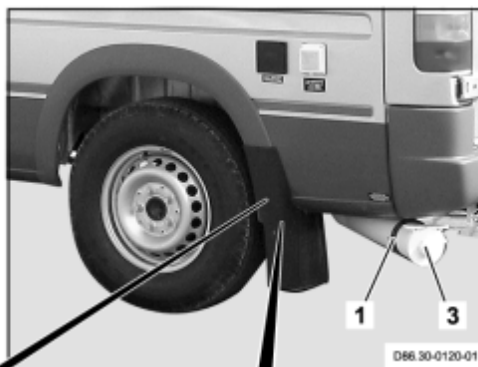
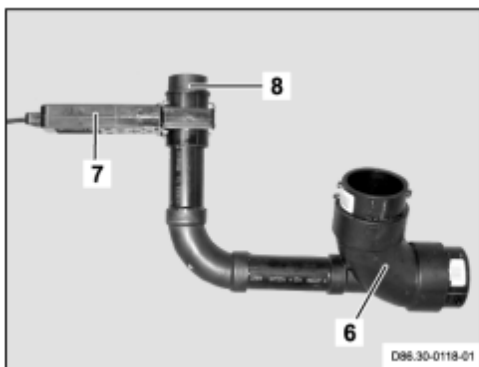

D86.30-0123-09

1 Clip
2 Clip
3 Drain pipe

4 Bracket
5 Hose
6 Sequence

7 Slide valve
8 Union nut

	Remove		
⚠ Danger!	Risk of death caused by vehicle slipping or toppling off of the lifting platform.	Align vehicle between the columns of the hydraulic hoist and position the four support plates below the hoist support points specified by the vehicle manufacturer.	AS00.00-Z-0010-01A
⚠ Danger!	Risk of injury caused by scraping or cutting body parts on sharp vehicle parts	Always wear protective gloves when working on or near sharp and undeburred vehicle parts. Deburr replacement panels.	AS00.00-Z-0017-01B
1	Drain wastewater tank	See Operating Instructions	
2	Slacken clamp (1)		

3	Slacken clamp (2)		
4	Remove drain pipe (3)		
5	Unscrew bracket (4) with handle from rear panel		
6	Disconnect hose (5) from drain (6)		
7	Unscrew union nut (8)		
8	Remove slide valve (7) with drain (6)	i Slide valve (7) is glued to drain (6) and cannot be separated from drain (6) without damage	
	Install		
9	Screw slide valve (7) to wastewater tank with union nut (8)		
10	Unscrew bracket (4) to rear panel with handle		
11	Install drain (6)	i Glue drain (6) to slide valve (7). Ensure that leakage is not present between both components	
		Sikaflex 252 adhesive for glued paneling	BR00.45-Z-1021-02A
12	Connect hose (5) to drain (6)		
13	Install drain pipe (4)		
14	Tighten clamp (2)		
15	Tighten clamp (1)		
16	Check sewer system for leakage		AR86.30-D-0071A

Auxiliary repair materials

Number	Designation	Order number
BR00.45-Z-1021-02A	Sikaflex 252 adhesive for glued paneling	005 989 36 71

MODEL 903.662

with CODE (ZU8) National version for USA

with CODE (Z29) "James Cook" touring camper, NAFTA

- 1 Union nuts
- 2 Sewer pipes
- 3 Bolts
- 4 Screw

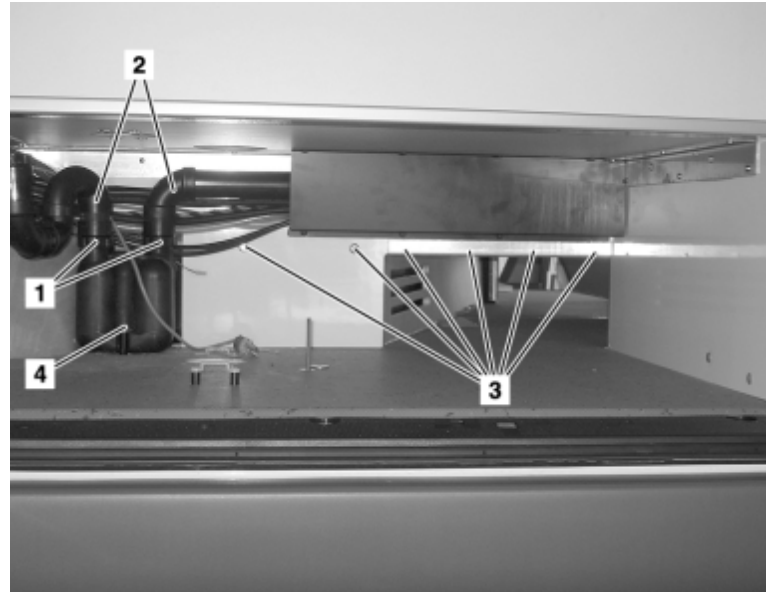

D86.30-0135-11

- 5 Hose clamp
- 6 Hose
- 7 Bolts
- 8 Wastewater tank

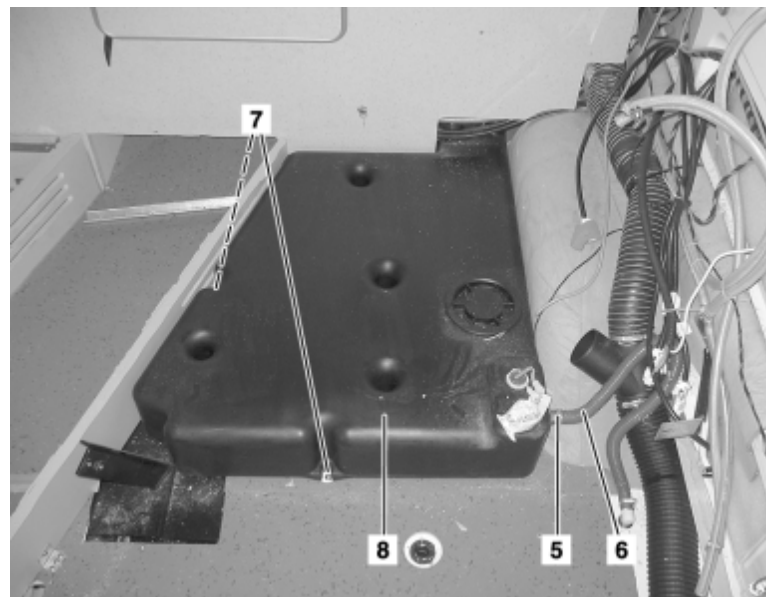

D86.30-0136-11

☒ ☒	Remove/Install		
⚠ Danger!	Risk of injury caused by scraping or cutting body parts on sharp vehicle parts	Always wear protective gloves when working on or near sharp and undeurred vehicle parts. Deburr replacement panels.	AS00.00-Z-0017-01B
1	Remove platform floor		AR68.20-D-

			2080A
2	Remove wastewater tank slide valve		AR86.30-D-0069A
3	Unscrew union nuts (2) from sewer pipes (2)		
4	Remove bolts (3)		
5	Unscrew bolt (4)		
6	Loosen hose clamp (5)		
7	Pull off hose (6)		
8	Unscrew bolts (7).		
9	Remove wastewater tank (8)		
10	Install in the reverse order		

MODEL 903.662

with CODE (ZU8) National version for USA

with CODE (Z29) "James Cook" touring camper, NAFTA

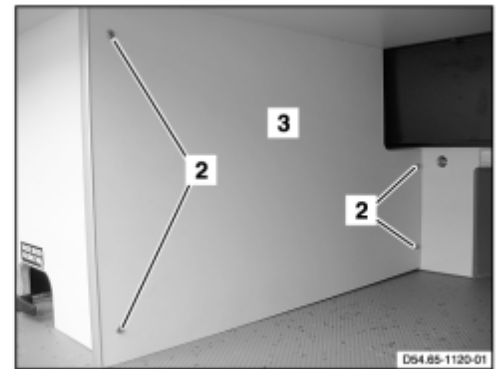
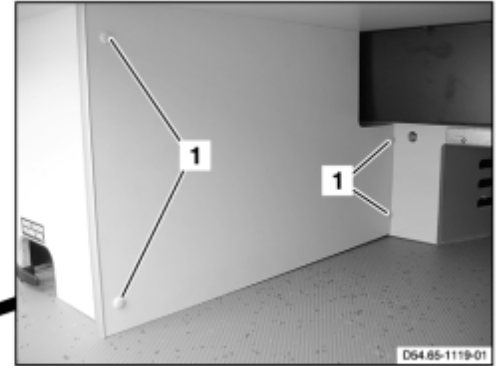

D54.65-1121-09

1 Caps

2 Bolts

3 Cover

4 Curtain
10 Pipe line



D86.30-0001-01

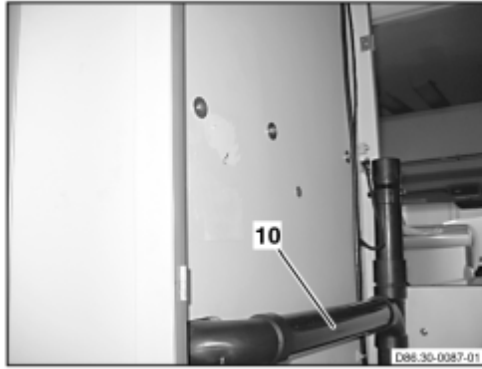

D86.30-0087-01



D86.30-0088-03

D86.30-0089-06

5 Strainer
6 Waste trap



D86.30-0090-01

7 Overflow pipe

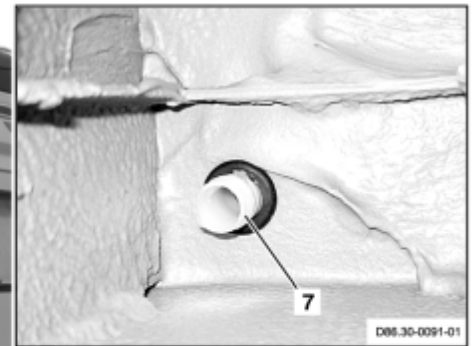

D86.30-0091-01

D86.30-0092-05

8 Pipe line



D86.30-0094-05

9 Pipe line



D86.30-0095-01



D86.30-0098-08

11 Pipelines

	<p>Check</p>		
<p>⚠ Danger!</p>	<p>Risk of injury caused by hot</p>	<p>Shut off the water heater in a</p>	<p>AS86.00-Z-0002-</p>

	water exiting from the lines of the fresh water system	timely manner before starting repair work. Let the water in the lines and in the components of the fresh water system cool down to room temperature.	01A
1	Remove caps (1)		
2	Unscrew bolts (2)		
3	Take out cover (3)		
4	Remove curtain (4)		
5	Remove sieve (5) from waste trap (6) in shower tray		
6	Plug waste trap (6) in shower tray		
7	Plug overflow pipe (7)		
8	Fill wastewater tank through boiler/sink combination and toilet	i Add water until water no longer drains out of boiler/sink combination and toilet	
9	Fill sanitary block wash basin	i Add water until water no longer drains out of wash basin	
10	Check entire pipeline (8) below boiler/sink combination for leakage, seal if necessary		
11	Check entire pipeline (9) below sanitary block wash basin for leakage, seal if necessary		
12	Check entire pipeline (10) in wardrobe for leakage, seal if necessary		
13	Check pipelines (11) behind excrement tank for leakage, seal if necessary		
14	Install in the reverse order		
15	Drain wastewater tank	i See Operator's Manual	

MODEL 903.662

with CODE (ZU8) Version for USA

with CODE (Z29) "James Cook" touring camper, NAFTA

1 Garbage bag holder



D86.30-0056-05



D86.30-0059-08

2 Bolts
3 Sheet metal

4 Floor panel
5 Heater hose

6 Plug connection
7 Water level sensor

7 Water level sensor
8 Thread
9 Float

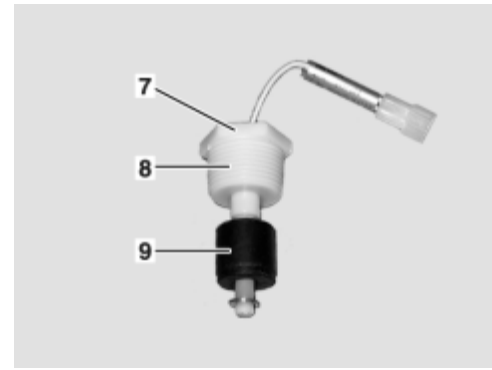

D86.30-0060-01

	Remove/Install		
1	Unhook garbage bag holder (1) and remove		
2	Unscrew bolts (2)		
3	Remove sheet metal (3)		
4	Remove floor panel (4)		
5	Remove heater hose (5)		
6	Separate connector (6)		
7	Unscrew water level sensor (7)	i Installation: Wrap thread (8) with 5 to 6 layers of Teflon tape and coat with glue	
8	Check water level sensor (7) for proper function	i Connect water level sensor (7) to connector and move float (9).The water level display should change in the central electric system	
9	Install in the reverse order		

MODEL 903.662

with CODE (ZU8) National version for USA

with CODE (Z29) "James Cook" touring camper, NAFTA

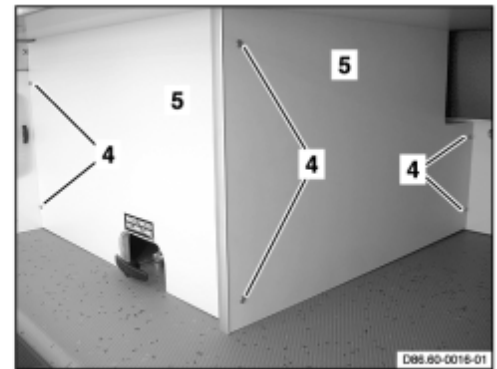
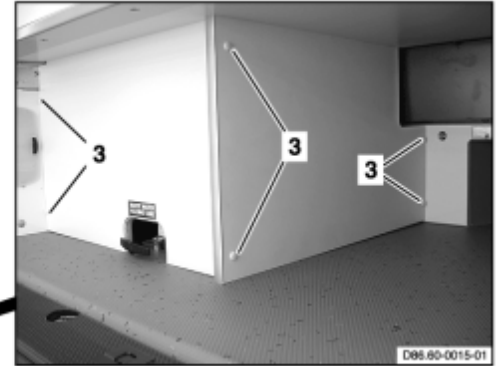

D86.60-0017-09

3 Caps

4 Bolts

5 Covers

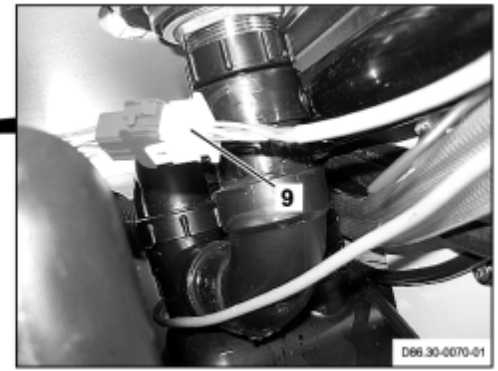
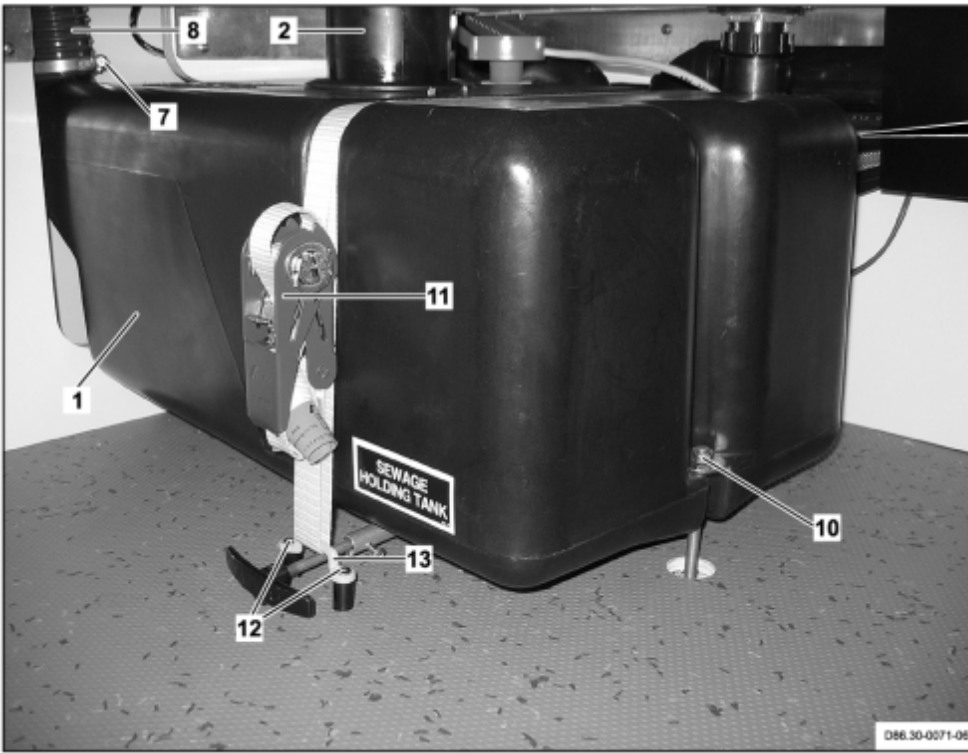

D86.30-0072-09

1 Excrement tank
2 Fitting
7 Clamp

8 Bleed hose
9 Electrical connector
10 Nut

11 Tensioning strap
12 Bolts
13 Anchoring lug

2 Fitting
6 Bolts

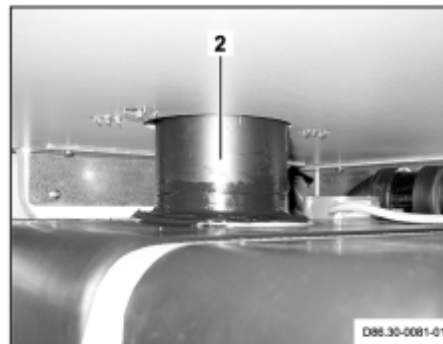

D86.30-0082-04

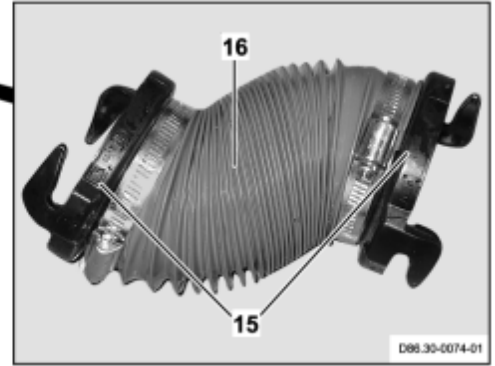
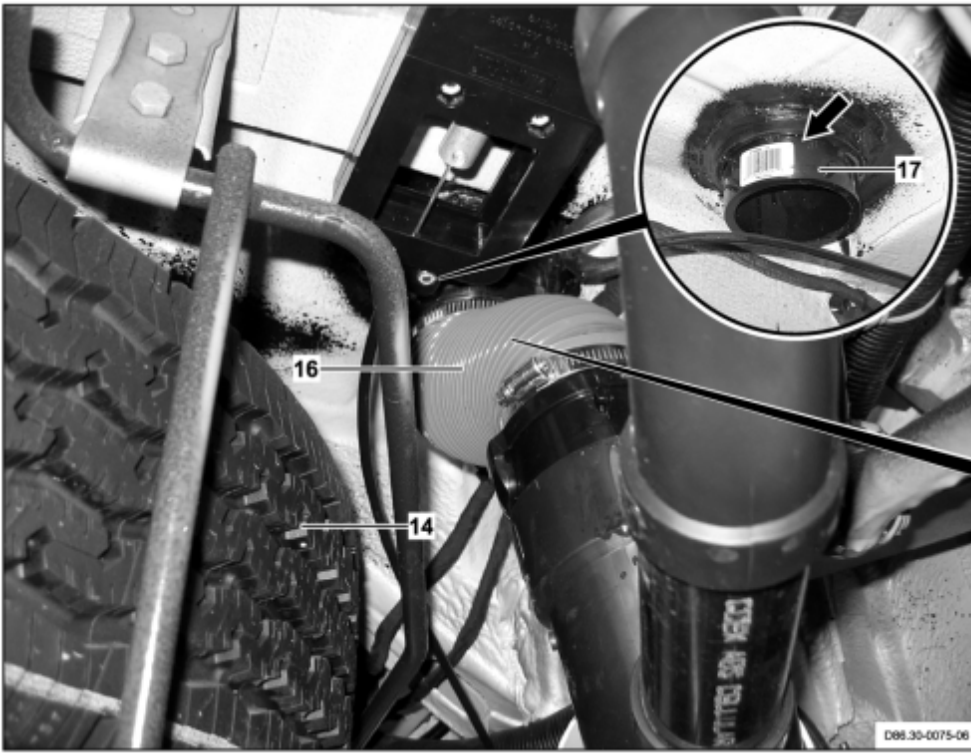

14 Spare wheel
15 Bayonet locks

16 Hose
17 Fitting



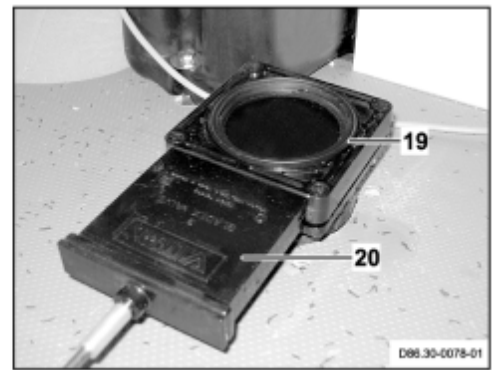
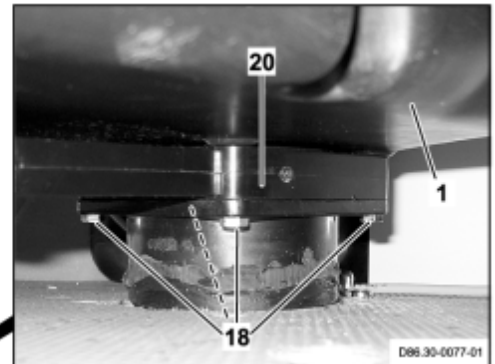
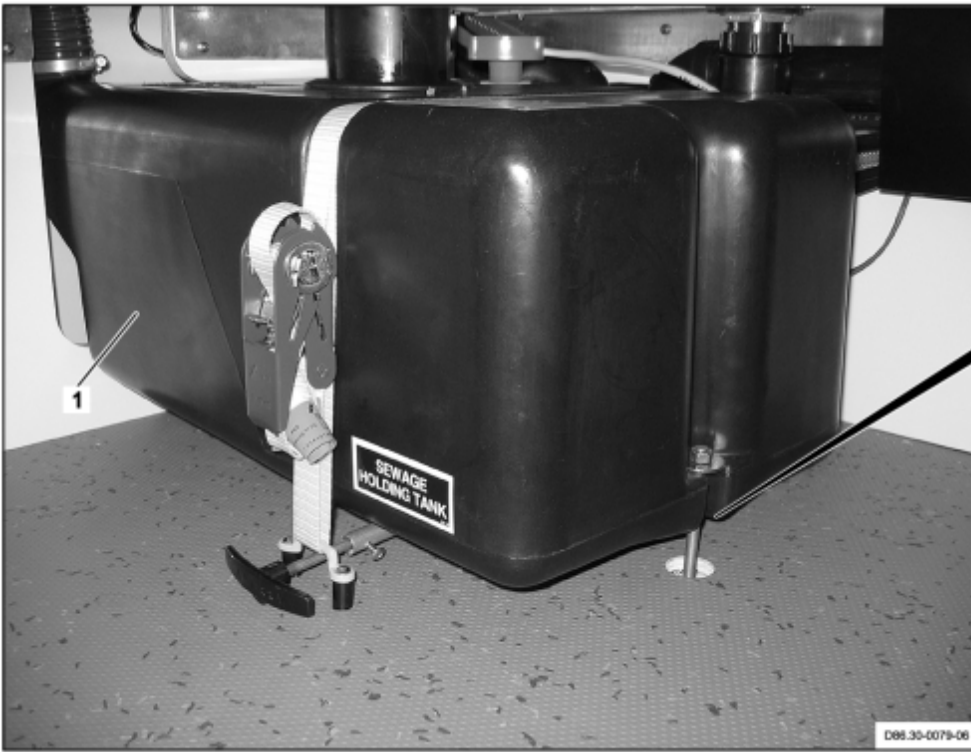

D86.30-0076-09





1 Excrement tank
18 Bolts

19 Gasket
20 Slide

D86.30-0080-09

 Danger!	Risk of death caused by vehicle slipping or toppling off of the lifting platform.	Align vehicle between the columns of the hydraulic hoist and position the four support plates below the hoist support points specified by the vehicle manufacturer.	AS00.00-Z-0010-01A
 Danger!	Risk of explosion caused by the ignition of methane gas exiting from components of the black water system and gray water system. Risk of injury caused by burns to the skin and eyes and by the inhalation of methane gas or by skin contact with feces.	Wear protective respiratory masks, protective gloves and safety glasses. Before commencing any work, ensure that all sources of ignition have been removed and the black water system has been completely emptied.	AS86.00-Z-0003-01A
1	Drain excrement tank (1)	 See Operator's Manual	
2	Remove caps (3)		
3	Remove bolts (4)		
4	Remove covers (5)		
5	Remove sealing compound between excrement tank (1) and fittings (2)		BR00.45-Z-1032-01A
6	Remove toilet		AR86.30-D-0074A
7	Unscrew bolts (6)		
8	Pull out fittings (2)		
9	Loosen clamp (7)		
10	Detach bleed hose (8)		
11	Disconnect electrical connector (9)		
12	Unscrew nut (10)		
13	Loosen tensioning belt (11)		
14	Unscrew the bolts (12).		
15	Remove anchoring lug (13)		
16	Remove spare wheel (14)	 See Operator's Manual	
17	Loosen bayonet locks (15)		
18	Remove hose (16)		
19	Remove sealing compound between vehicle floor and fittings (17) (arrow)		BR00.45-Z-1032-01A

20	Lift excrement tank (1)	 Until screws (18) are accessible.	
21	Remove bolts (18)		
22	Remove excrement tank (1)	 Installation: Check gasket (19) on slide (20) for damage, replace if necessary, otherwise leakage can occur on the excrement tank (1).	
23	Install in the reverse order		
24	Check wastewater system for leakage		AR86.30-D-0071A

Auxiliary repair materials

Number	Designation	Order number
BR00.45-Z-1032-01A	Sikaflex 221 sealing compound	001 989 64 20

MODEL 903.662

with CODE (ZU8) National version for USA

with CODE (Z29) "James Cook" touring camper, NAFTA

1 Toilet cover

2 Covering



D86.30-0033-02



D86.30-0035-09

3 Nuts

4 Toilet

5 Electrical connector

6 Hose clamp
7 Hose

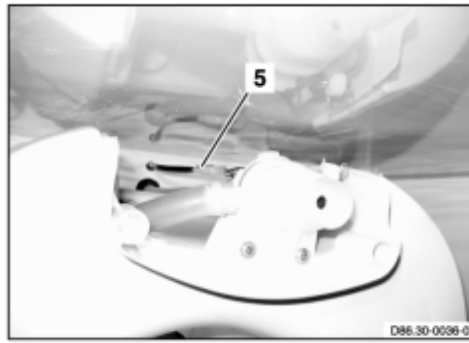

D86.30-0038-04

	Remove/Install		
Danger!	Risk of explosion caused by the ignition of methane gas exiting from components of the black water system and gray water system. Risk of injury caused by burns to the skin and eyes and by the inhalation of methane gas or by skin contact with feces.	Wear protective respiratory masks, protective gloves and safety glasses. Before commencing any work, ensure that all sources of ignition have been removed and the black water system has been completely emptied.	AS86.00-Z-0003-01A
1	Drain excrement tank	Rinse excrement tank with water, via toilet (4), since toxic vapors may form in the excrement tank.	
2	Remove toilet cover (1)		AR86.30-D-0077A
3	Unclip cover (2)	Perform on both sides	
4	Remove cover (2) in direction of arrow		
5	Remove nuts (3)		
6	Slightly tilt toilet (4) toward front	Until electrical connector (5) and hose (7) are accessible	
7	Disconnect electrical connector (5)		
8	Slacken hose clamp (6)		
9	Pull off hose (7)	Installation: Ensure that hose (7) is not pinched	
10	Remove toilet (4)		
11	Install in the reverse order		
12	Check fresh water system for leakage		AR86.30-D-0065A
13	Check toilet (4) for proper		

function

MODEL 903.662

with CODE (ZU8) National version for USA

with CODE (Z29) "James Cook" touring camper, NAFTA

1 Water level sensor

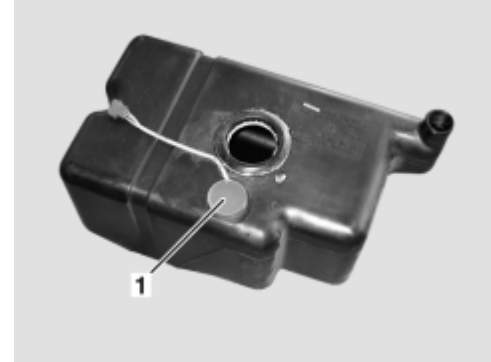

D86.30-0039-01

☒ ☒	Remove/Install		
<p>⚠ Danger!</p>	<p>Risk of explosion caused by the ignition of methane gas exiting from components of the black water system and gray water system. Risk of injury caused by burns to the skin and eyes and by the inhalation of methane gas or by skin contact with feces.</p>	<p>Wear protective respiratory masks, protective gloves and safety glasses. Before commencing any work, ensure that all sources of ignition have been removed and the black water system has been completely emptied.</p>	<p>AS86.00-Z-0003-01A</p>
1	Remove excrement tank		<p>AR86.30-D-0073A</p>
2	Unscrew water level sensor (1)		
3	Install in the reverse order		

MODEL 903.662

with CODE (ZU8) Version for USA

with CODE (Z29) "James Cook" touring camper, NAFTA

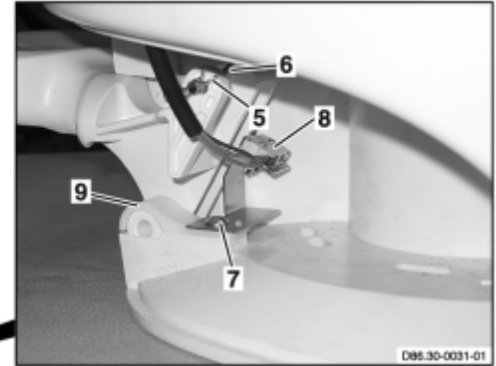
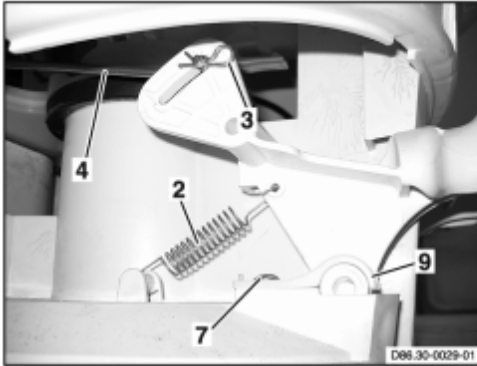



D86.30-0032-08

1 Covering
2 Spring
3 Cotter pin
4 Linkage

5 Cotter pin
6 Linkage
7 Bolts

8 Switch
9 Bracket
10 Toilet flushing handle

	Remove/Install		
1	Unclip cover (1).	 On both sides	
2	Remove cover (1) in direction of arrow		
3	Detach spring (2)		
4	Pull out cotter pin (3)		
5	Unhook linkage (4)		
6	Pull out cotter pin (5)		
7	Detach linkage (6)		
8	Remove bolts (7)	 Installation: Ensure that switch (8) is positioned correctly	
9	Remove bracket (9)		
10	Remove toilet flushing handle (10)		

11	Install in the reverse order		
12	Check toilet flushing handle (10) for proper function		

MODEL 903.662

with CODE (ZU8) Version for USA

with CODE (Z29) "James Cook" touring camper, NAFTA

1 Toilet cover



D86.30-0040-01

 	Remove/Install		
1	Open toilet cover (1)		
2	Remove toilet cover (1) upward		
3	Install in the reverse order		

MODEL 903.662

with CODE (ZU8) Version for USA

with CODE (Z29) "James Cook" touring camper, NAFTA

1 Outlet cover

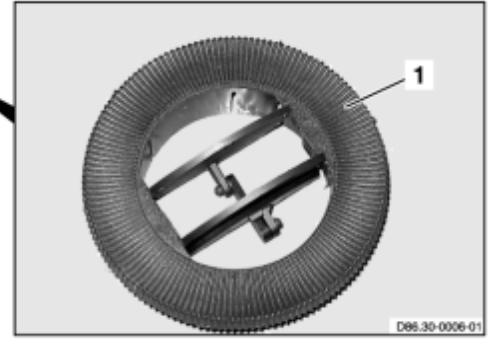

D86.30-0007-04

	<p>Remove/Install</p>		
<p>1</p>	<p>Remove outlet cover (1)</p>		
<p>2</p>	<p>Install in the reverse order</p>		

MODEL 903.662

with CODE (ZU8) National version for USA

with CODE (Z29) "James Cook" touring camper, NAFTA

1 Curtain

2 Air admission valve



D86.30-0004-06

	Remove/Install		
1	Slide curtain (1) to side		
2	Unscrew air admission valve (2)	i Installation: Grease air admission valve thread (2) with lubricant.	
3	Install in the reverse order		

MODEL 903.662

with CODE (ZU8) National version for USA

with CODE (Z29) "James Cook" touring camper, NAFTA

1 Shower head

2 Shower hose

3 O-ring



D86.30-0028-04

☒ ☒	Remove/Install		
⚠ Danger!	Risk of injury caused by hot water exiting from the lines of the fresh water system	Shut off the water heater in a timely manner before starting repair work. Let the water in the lines and in the components of the fresh water system cool down to room temperature.	AS86.00-Z-0002-01A
1	Pull out shower head (1) with shower hose (2)		
2	Unscrew shower head (1)	i Installation: Check O-ring (3) for damage, replace if necessary.	
3	Install in the reverse order		
4	Check shower head (1) for leakage		

MODEL 903.662

with CODE (ZU8) National version for USA

with CODE (Z29) "James Cook" touring camper, NAFTA

1 Curtain

2 Bolts



D86.30-0010-06

3 Rail

4 Mirror



D86.30-0011-11

	<p>Remove/Install</p>		
<p>1</p>	<p>Remove curtain (1)</p>		

2	Unscrew bolts (2)		
3	Remove strip (3)		
4	Unscrew mirror (4)	 Carefully remove and install mirror (4) to prevent mirror glass from breaking.	
5	Install in the reverse order		

MODEL 903.662

with CODE (ZU8) Version for USA

with CODE (Z29) "James Cook" touring camper, NAFTA

1 Bolts

2 Shower head bracket

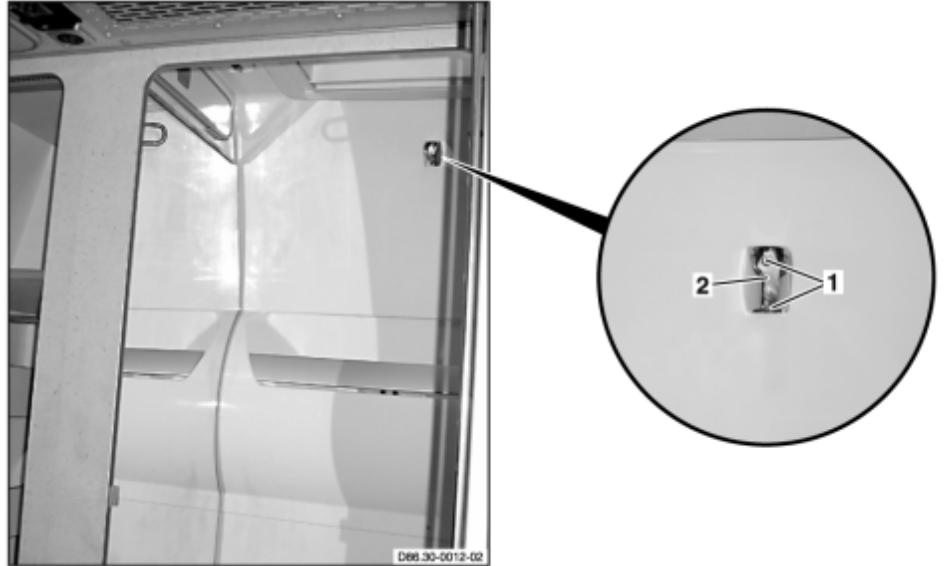

D86.30-0013-05

☒ ☒	Remove/Install		
1	Remove bolts (1)		
2	Remove shower head bracket (2)		
3	Install in the reverse order		

MODEL 903.662

with CODE (ZU8) Version for USA

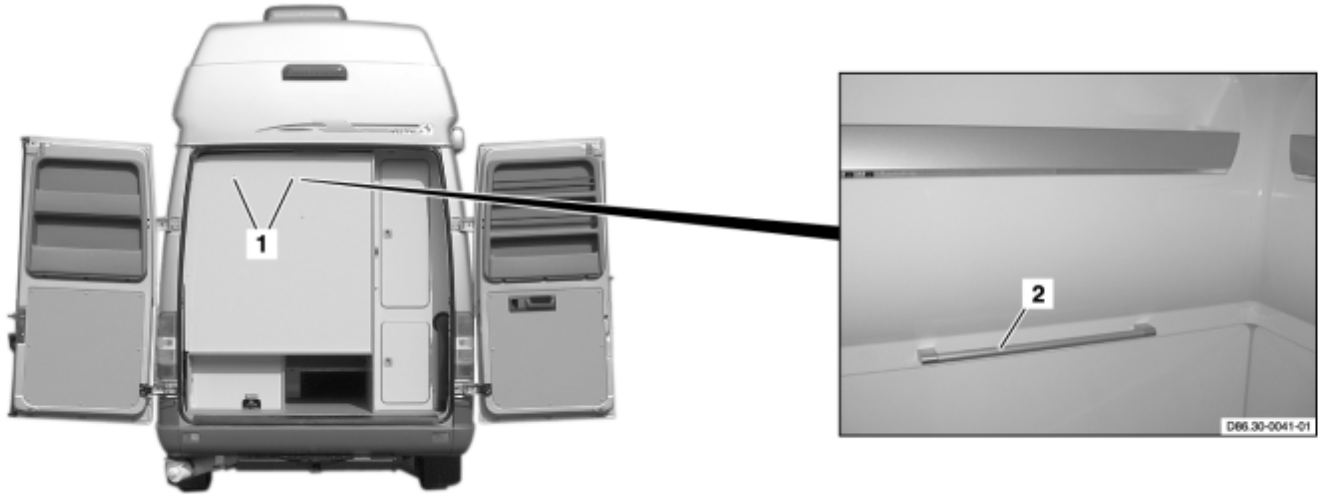

with CODE (Z29) "James Cook" touring camper, NAFTA



D86.30-0042-08

1 Bolts

2 Towel holder

	Remove/Install		
1	Remove bolts (1)	 Helper holds towel holder (2) on sanitary block	
2	Remove towel holder (2)		
3	Install in the reverse order		

MODEL 903.662

with CODE (ZU8) National version for USA

with CODE (Z29) "James Cook" touring camper, NAFTA

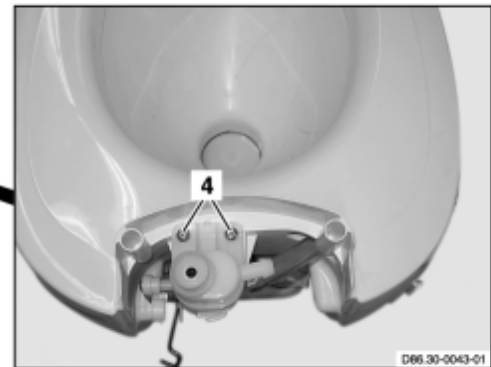
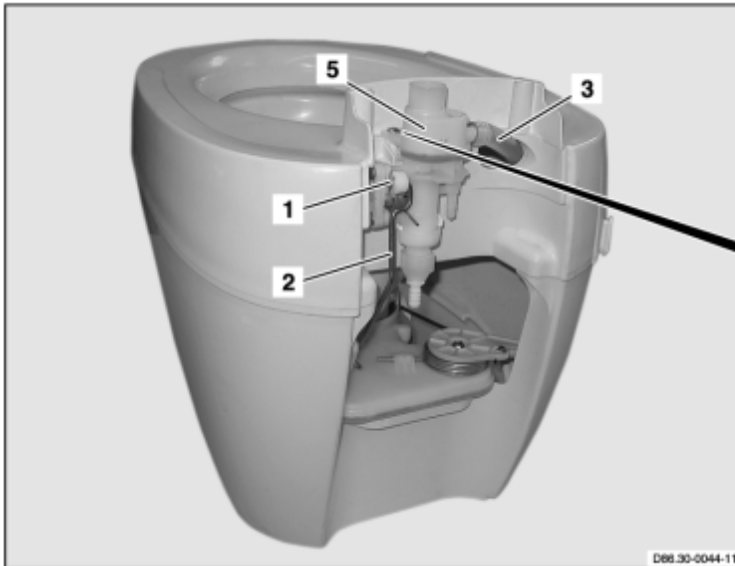

D86.30-0045-08

1 Retaining splint
2 Linkage

3 Hose
4 Bolts

5 Water module

☒ ☒	Remove/Install		
<p>⚠ Danger!</p>	<p>Risk of explosion caused by the ignition of methane gas exiting from components of the black water system and gray water system. Risk of injury caused by burns to the skin and eyes and by the inhalation of methane gas or by skin contact with feces.</p>	<p>Wear protective respiratory masks, protective gloves and safety glasses. Before commencing any work, ensure that all sources of ignition have been removed and the black water system has been completely emptied.</p>	<p>AS86.00-Z-0003-01A</p>
1	Remove toilet		<p>AR86.30-D-0074A</p>
2	Pull out retaining splint (1)		
3	Unhook linkage (2)		
4	Pull off hose (3)		
5	Remove bolts (4)		
6	Remove water module (5)		
7	Install in the reverse order		

MODEL 903.662

with CODE (ZU8) National version for USA

with CODE (Z29) "James Cook" touring camper, NAFTA

- 1 Retaining splint
- 2 Linkage
- 3 Retaining splint
- 4 Linkage
- 7 Toilet top section

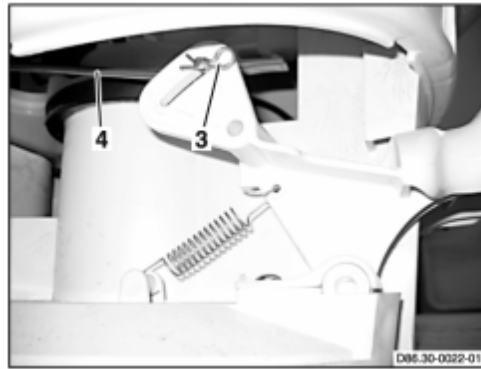
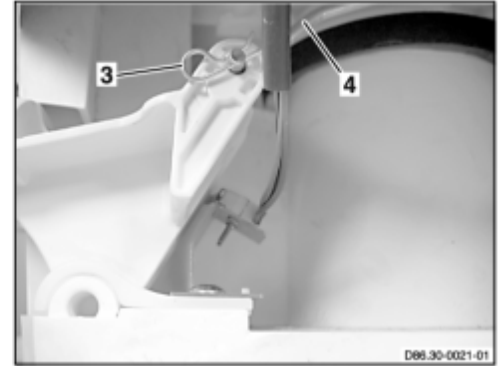

D86.30-0023-06

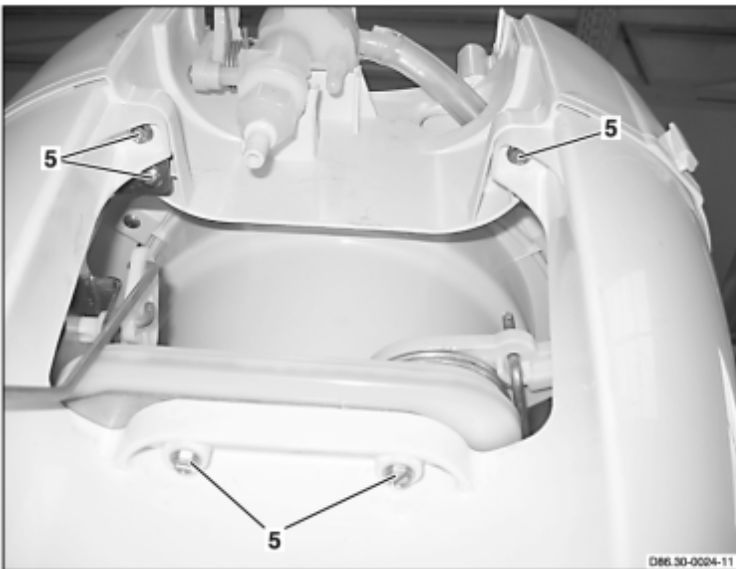

D86.30-0026-08

5 Bolts

6 Screw



Remove/Install

<p>⚠ Danger!</p>	<p>Risk of explosion caused by the ignition of methane gas exiting from components of the black water system and gray water system. Risk of injury caused by burns to the skin and eyes and by the inhalation of methane gas or by skin contact with feces.</p>	<p>Wear protective respiratory masks, protective gloves and safety glasses. Before commencing any work, ensure that all sources of ignition have been removed and the black water system has been completely emptied.</p>	<p>AS86.00-Z-0003-01A</p>
<p>1</p>	<p>Remove toilet</p>		<p>AR86.30-D-0074A</p>
<p>2</p>	<p>Pull out retaining splint (1)</p>		
<p>3</p>	<p>Unhook linkage (2)</p>		
<p>4</p>	<p>Pull retaining splint (3) out of toilet flushing actuation</p>		
<p>5</p>	<p>Unhook linkage (4) from toilet flushing actuation</p>		
<p>6</p>	<p>Unscrew bolts (5)</p>		
<p>7</p>	<p>Unscrew bolt (6)</p>	<p>i Turn toilet 180°</p>	
<p>8</p>	<p>Remove toilet top section (7)</p>		
<p>9</p>	<p>Install in the reverse order</p>		

MODEL 903.662

with CODE (ZU8) National version for USA

with CODE (Z29) "James Cook" touring camper, NAFTA

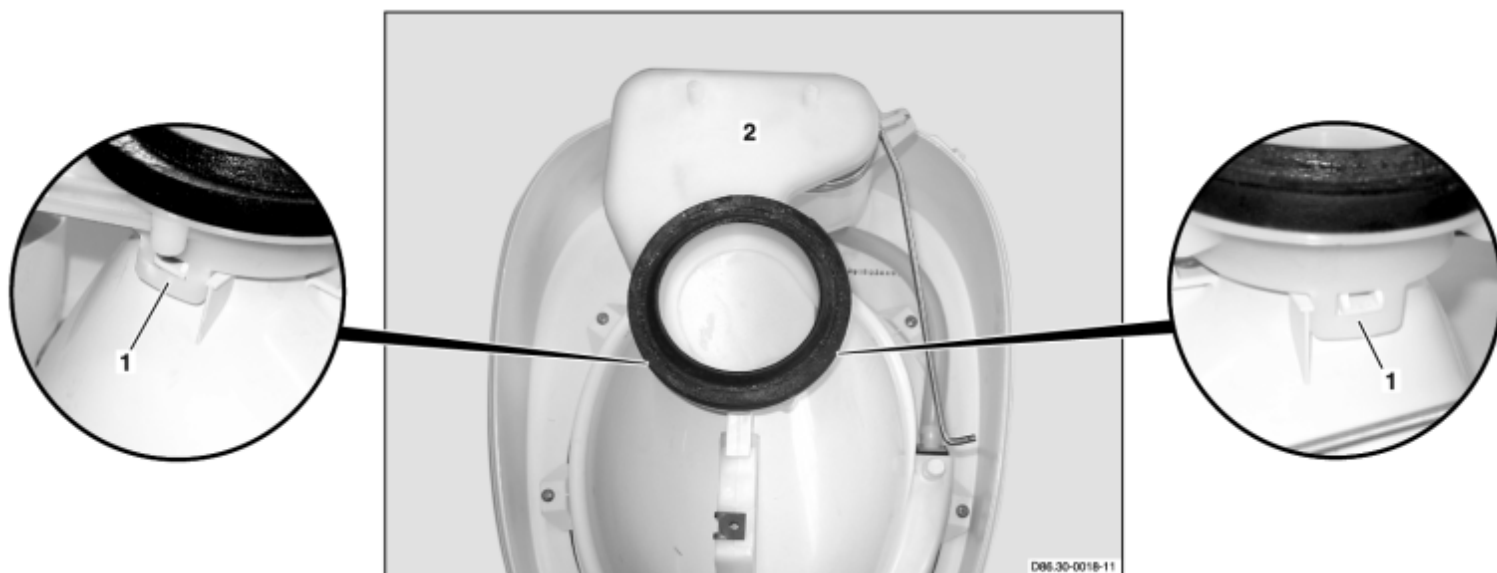

D86.30-0019-08

1 Retaining lug

2 Slide

☒ ☒	Remove/Install		
<p>⚠ Danger!</p>	<p>Risk of explosion caused by the ignition of methane gas exiting from components of the black water system and gray water system. Risk of injury caused by burns to the skin and eyes and by the inhalation of methane gas or by skin contact with feces.</p>	<p>Wear protective respiratory masks, protective gloves and safety glasses. Before commencing any work, ensure that all sources of ignition have been removed and the black water system has been completely emptied.</p>	<p>AS86.00-Z-0003-01A</p>
1	Remove toilet top section		<p>AR86.30-D-0085A</p>
2	Release retaining lugs (1)		
3	Remove slider (2)	<p>i Installation: Check sealing rings for damage, replace if necessary.</p>	
4	Install in the reverse order		

MODEL 903.662

with CODE (ZU8) National version for USA

with CODE (Z29) "James Cook" touring camper, NAFTA

- 1 Flap
- 2 Screw
- 3 Clothes line

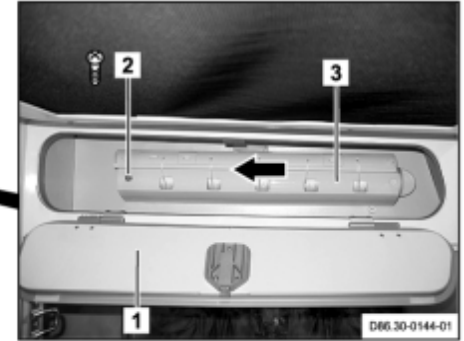

D86.30-0145-04

	Remove/Install		
1	Open flap (1)		
2	Unscrew bolt (2).		
3	Slide clothes line (3) to left (arrow)		
4	Remove clothes line (3)		
5	Install in the reverse order		

MODEL 903.662

with CODE (ZU8) National version for USA

with CODE (Z29) "James Cook" touring camper, NAFTA

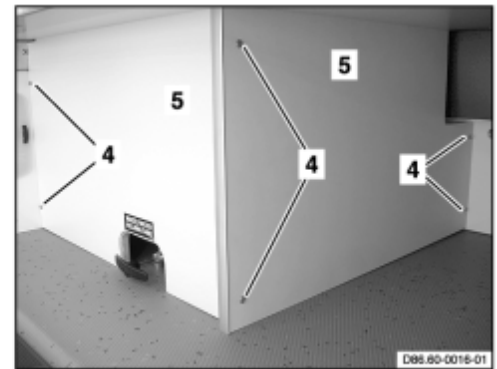
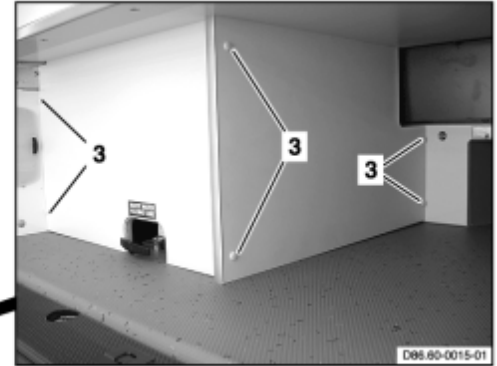

D86.60-0017-09

3 Caps

4 Bolts

5 Covers

2 Fitting
6 Bolts

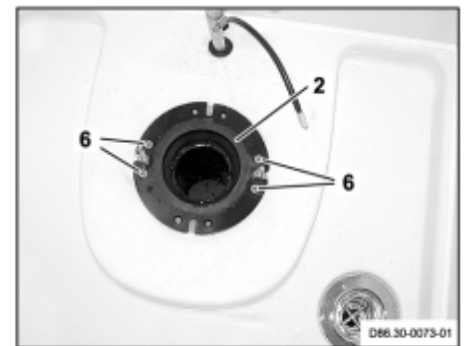
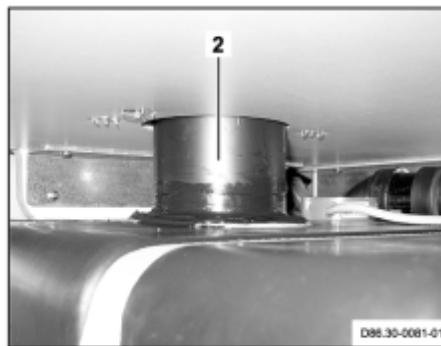

D86.30-0082-04

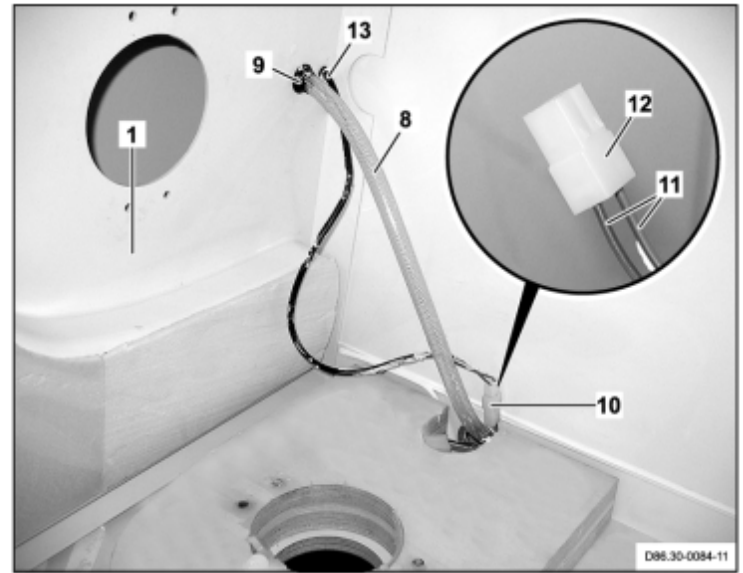
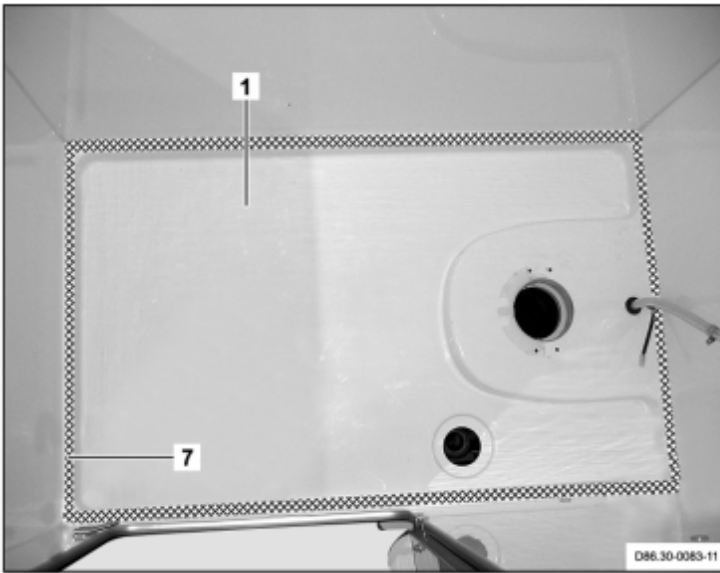





D86.30-0085-08

1 Shower tray
7 Sealing compound
8 Hose

9 Grommet
10 Electrical connector
11 Electrical lines

12 Electrical connector
13 Grommet

	Remove		
Danger!	Risk of injury caused by scraping or cutting body parts on sharp vehicle parts	Always wear protective gloves when working on or near sharp and non-deburred vehicle parts. Deburr repair panels.	AS00.00-Z-0017-01B
Danger!	Risk of explosion caused by the ignition of methane gas exiting from components of the black water system and gray water system. Risk of injury caused by burns to the skin and eyes and by the inhalation of methane gas or by skin contact with feces.	Wear protective respiratory masks, protective gloves and safety glasses. Before commencing any work, ensure that all sources of ignition have been removed and the black water system has been completely emptied.	AS86.00-Z-0003-01A
1	Remove toilet		AR86.30-D-0074A
2	Remove sanitary block wash basin		AR86.60-D-0009A
3	Remove caps (3)		
4	Remove bolts (4).		
5	Remove covers (5)		
6	Remove sealing compound between excrement tank and fittings (2)		

7	Unscrew bolts (6)		
8	Pull out fittings (2)		
9	Remove waste trap from shower tray (1)		AR86.60-D-0072A
10	Cut sealing compound (7)		
11	Loosen shower tray (1) from floor in sanitary block	 Pry out shower tray (1) in area of door with suitable tool	
		 Carefully remove shower tray (1) to prevent damaging door and walls	
12	Install shower tray (1)		
13	Move hose (8) with grommet (9) out of shower tray (1)		
14	Disconnect electrical connector (10)		
15	Unpin electrical lines (11) from plug housing (12)		
16	Remove electrical lines (11) from shower tray (1) with grommet (13)		
17	Remove shower tray (1)		
	Install		
18	Prepare shower tray (1) for installation		AR86.60-D-0009-01A
19	Lift shower tray (1) into sanitary block		
20	Install electrical lines (11) in shower tray (1) with grommet (13)		
21	Pin electrical lines (11) into plug housing (12)		
22	Connect electrical connector (10)		
23	Install hose (8) with grommet (9) in shower tray (1)		
24	Coat floor of sanitary block with glue	 Use suitable glue.	
25	Lay shower tray (1) on sanitary block floor		
26	Uniformly distribute weights in	 Load with 15 kg and wait until	

	shower tray (1)	glue has cured	
27	Mask sanitary block walls in area (7) with masking tape		
28	Apply sealing compound in area (7)	i Use suitable sealing compound	
29	Install waste trap in shower tray (1)		AR86.60-D-0072A
30	Insert fittings (2)		
31	Screw in screws (6)		
32	Apply sealing compound between excrement tank and fittings (2)	Sikaflex 221 sealing compound	BR00.45-Z-1032-01A
33	Install sanitary block wash basin		AR86.60-D-0009A
34	Install toilet		AR86.30-D-0074A
35	Check wastewater system for leakage		AR86.30-D-0071A
36	Check fresh water system for leakage		AR86.30-D-0065A
37	Insert cover (5)		
38	Screw in bolts (4)		
39	Install caps (3)		

Auxiliary repair materials

Number	Designation	Order number
BR00.45-Z-1032-01A	Sikaflex 221 sealing compound	001 989 64 20

MODEL 903.662

with CODE (ZU8) National version for USA

with CODE (Z29) "James Cook" touring camper, NAFTA

- 1 Nut
- 2 Gas line
- 38 Bolts

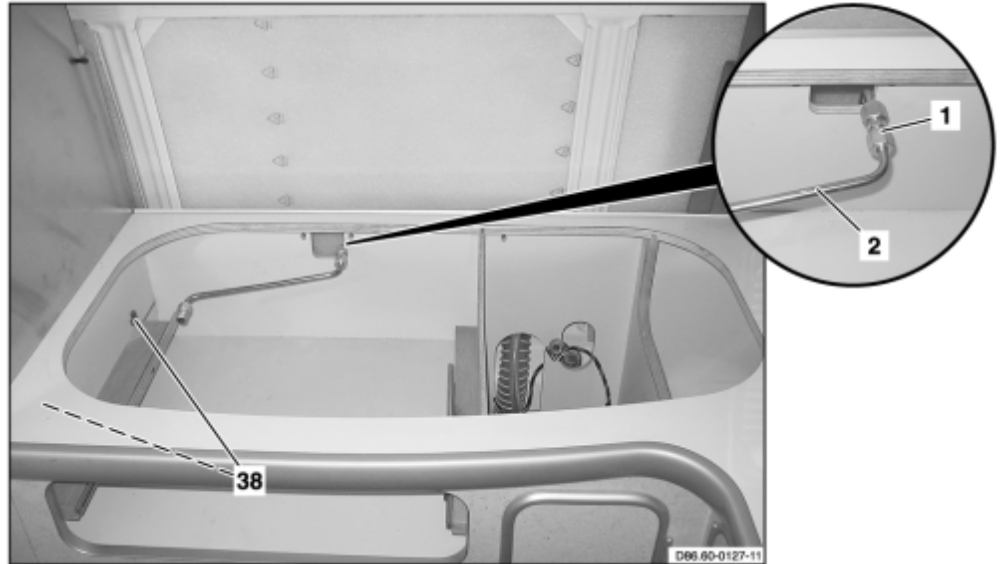

D86.60-0126-05

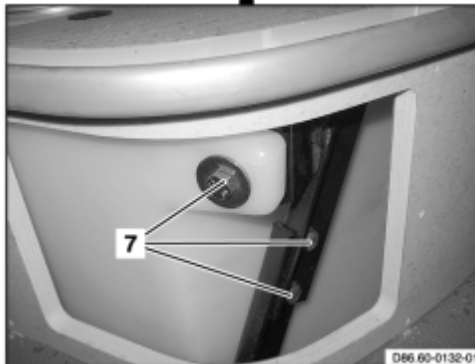
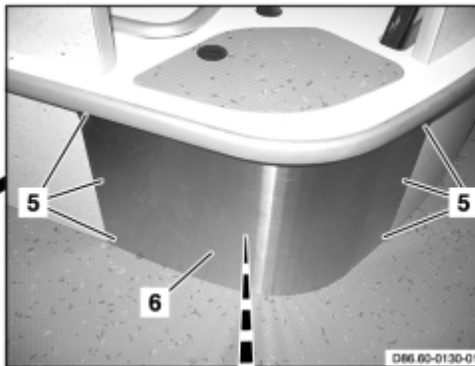
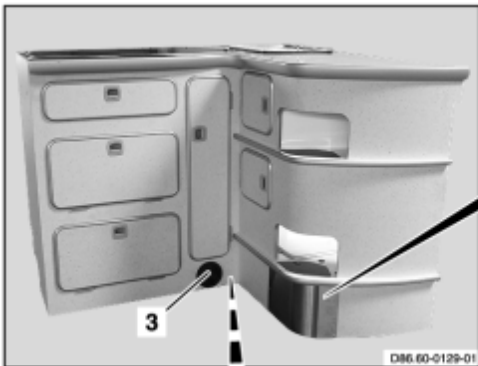

D86.60-0128-09

- 3 Air nozzle
- 4 Screw
- 5 Bolts

- 6 Covering
- 7 Bolts

- 27 Bolts
- 28 Clip

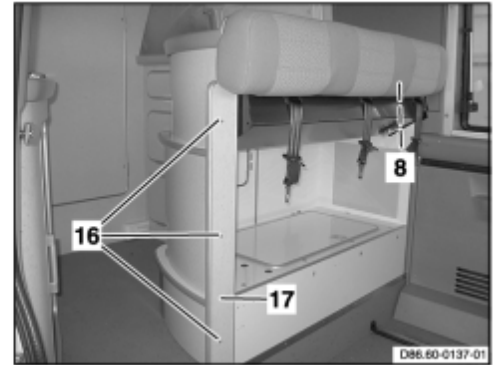
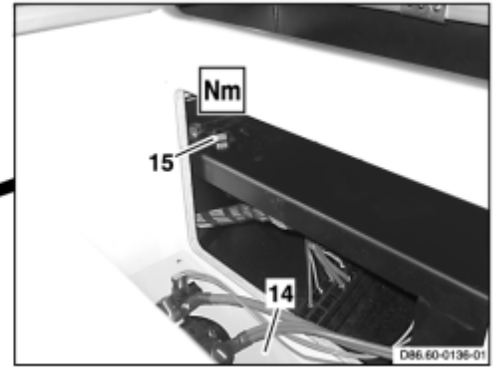
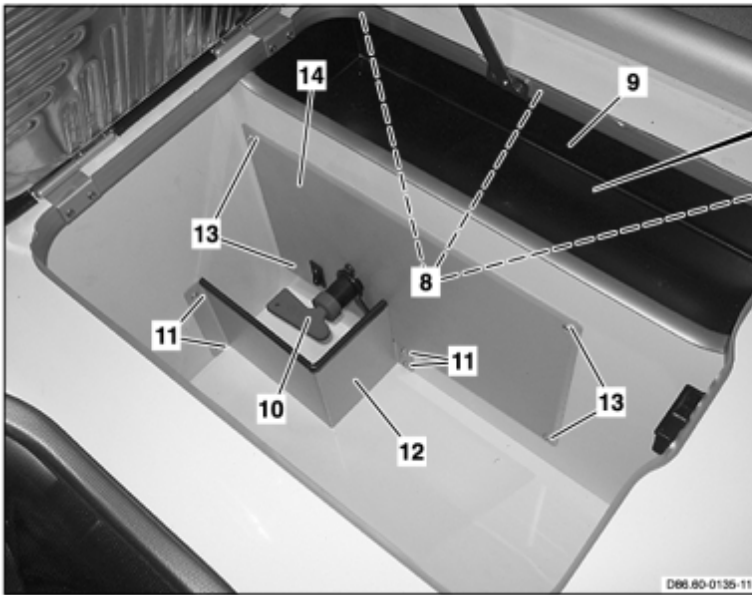

D86.60-0134-09

8 Bolts
 9 Utensil insert
 10 12-V main switch
 11 Bolts

12 Locking plate
 13 Bolts
 14 12 V main switch carrier plate
 15 Nm Screw

16 Bolts
 17 Covering

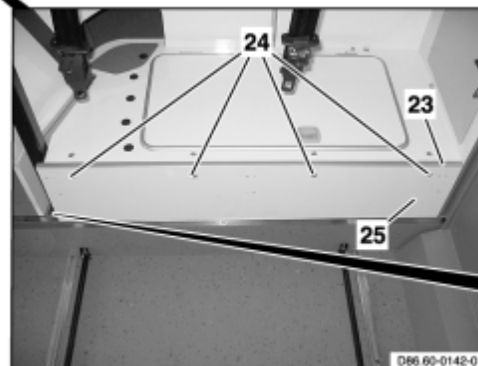
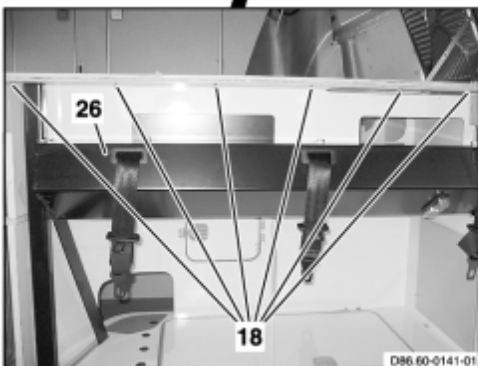
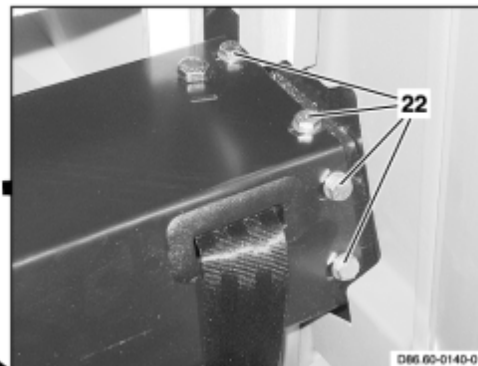
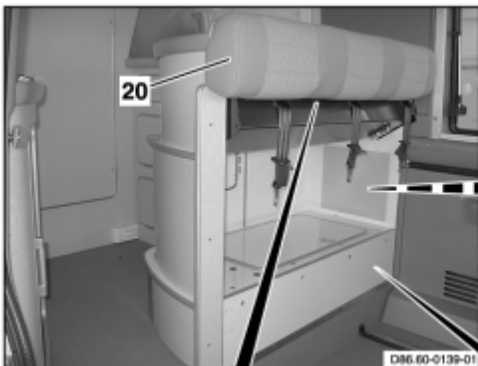

D86.60-0138-09

18 Bolts

22 Bolts

25 Covering

20 Head restraint strip
21 Bolts

23 Protective strip
24 Bolts

26 Belt support

19 Seal
29 Bolts

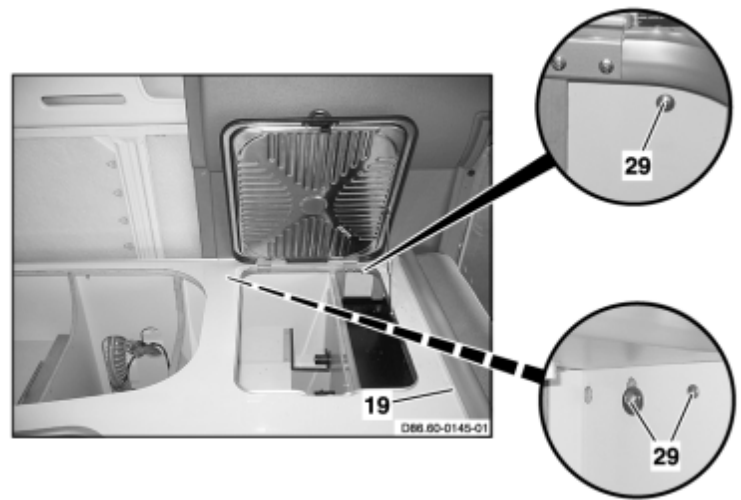

D86.60-0144-11

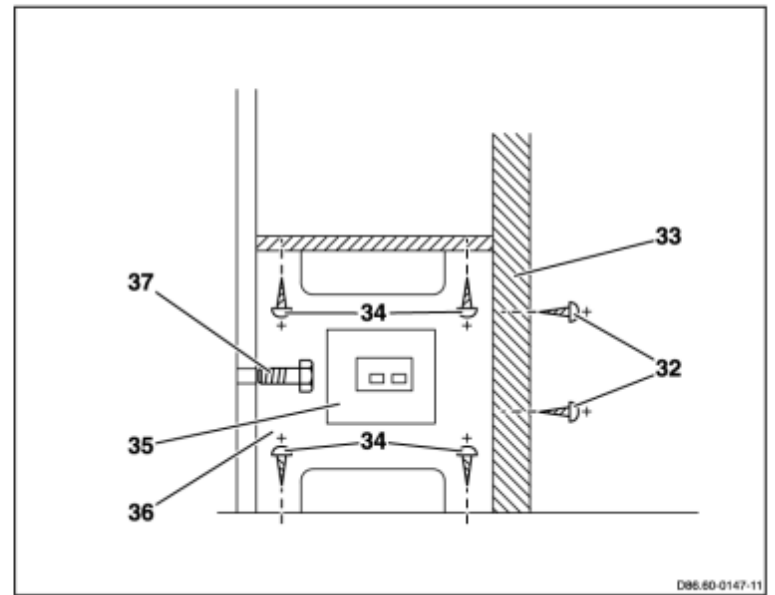
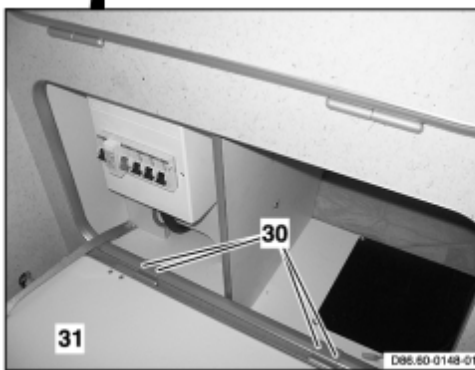
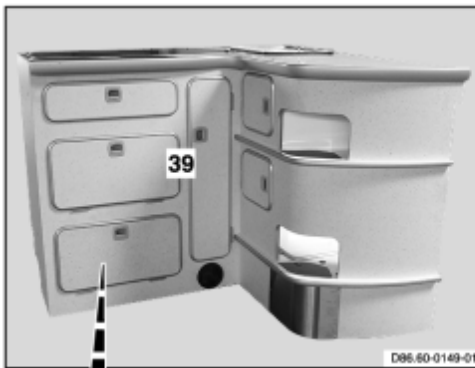



D86.60-0146-09





30 Bolts
31 Flap
32 Bolts

33 Partition wall
34 Bolts
35 110-V circuit breaker

36 Bracket
37 Screw
39 Kitchen element

	<p>Remove/Install</p>		
<p>⚠ Danger!</p>	<p>Risk of injury caused by scraping or cutting body parts on sharp vehicle parts</p>	<p>Always wear protective gloves when working on or near sharp and undebarred vehicle parts.</p>	<p>AS00.00-Z-0017-01B</p>

		Deburr replacement panels.	
 Danger!	Injury hazard from doors, covers, flaps or loose components pinching or cutting off extremities.	No body parts should be within the motion area when moving doors, covers, flaps and components. Always wear protective gloves	AS00.00-Z-0025-01A
 Danger!	Risk of death from coming into contact with electrical parts of the 110 V system Injury hazard from burns caused by an electric shock or direct power flow through body parts	Do not touch voltage conducting parts in the 110 V system.	AS00.00-Z-0027-01A
 Danger!	Explosion hazard from ignition of gas exiting the gas line system of the vehicle Injury hazard to skin and eyes due to burns	Before starting work, ensure that all ignition sources are eliminated, if necessary completely empty gas system Wear protective clothing.	AS86.00-Z-0004-01A
1	Remove bench		AR91.21-D-4000A
2	Remove bed extension		AR91.75-D-0010A
3	Remove fuse box	On belt support	AR54.15-D-1256A
4	Remove cooker/sink combination		AR86.60-D-0010A
5	Unscrew nut (1)		
6	Remove gas line (2)		
7	Remove gas sensor		AR54.65-D-0011A
8	Remove air outlet (3)	Kitchen element air outlet	AR83.70-D-3000A
9	Remove bolts (27).		
10	Remove clamp (28)		
11	Unscrew bolt (4)		
12	Unscrew bolts (5).		
13	Remove covering (6)		
14	Unscrew bolts (7).		
15	Unscrew bolts (8) from utensil insert (9)		
16	Remove utensil insert (9)		

17	Turn 12 V main switch (10) to "OFF" position		
18	Unscrew bolts (11).		
19	Remove locking plate (12)		
20	Unscrew bolts (13).		
21	Lay 12 V main switch carrier plate (14) down to side		
22	Loosen screw (15)	 Bolt, automatic belt retractor to rear seat	BA91.40-N-1009-01A
23	Remove caps from screws (16)		
24	Remove bolts (16)		
25	Remove covering (17)		
26	Loosen screws (18)		
27	Separate sealing seam (19)	 Installation: Use suitable sealant	
28	Remove head restraint strip (20)		
29	Remove bolts (21).		
30	Remove bolts (22).		
31	Pull off protective strip (23)		
32	Remove bolts (24).		
33	Remove covering (25)		
34	Remove belt support (26)	 Remove belt support (26) with aid of helper to prevent damage	
35	Remove bolts (30).		
36	Remove flap (31)		
37	Remove bolts (32).		
38	Slide partition wall (33) to side		
39	Remove bolts (34).		
40	Fold over 110-V circuit breaker (35) with bracket (36)		
41	Remove screw (37)		
42	Remove bolts (38).		
43	Remove kitchen element (39)	 Helper required	
44	Install in the reverse order		

45

Function test

i Check all affected components for proper function

Nm Seat belts/emergency tensioning retractors

Number	Designation		Nm	Model 903.662 with code ZU8, Z29
BA91.40-N-1009-01A	Bolt, automatic belt retractor to rear seat		38	

MODEL 903.662

with CODE (ZU8) National version for USA

with CODE (Z29) "James Cook" touring camper, NAFTA

- 1 Curtain
- 2 Hose clamps
- 3 and hoses
- 4 Foam material
- 5 Electrical connector
- 6 Hose guides

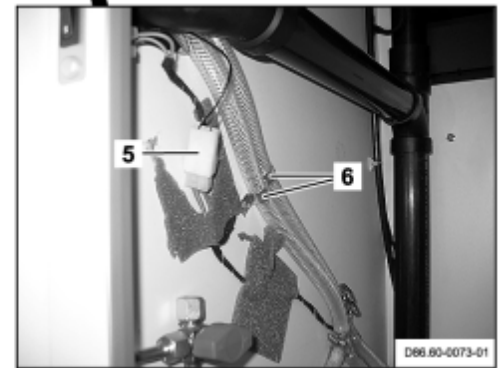
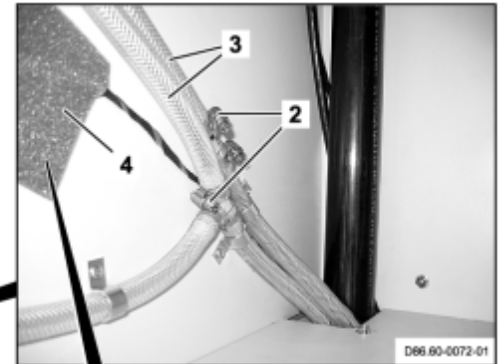

D86.60-0075-06

- 7 Screw
- 8 Sewer pipe
- 9 Bolts

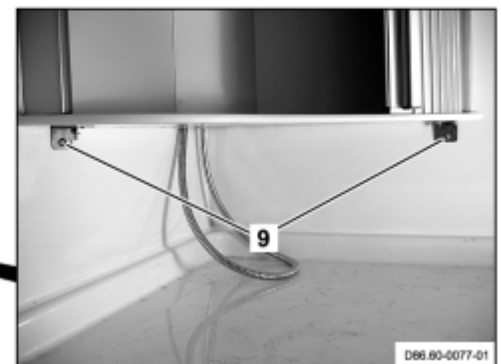
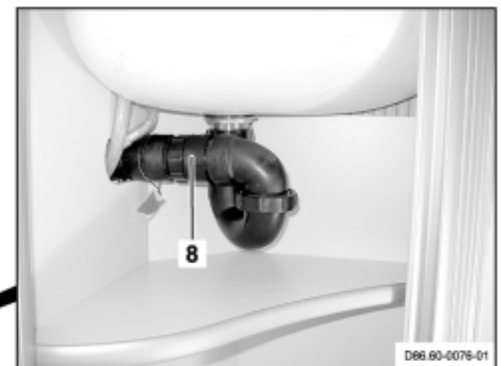

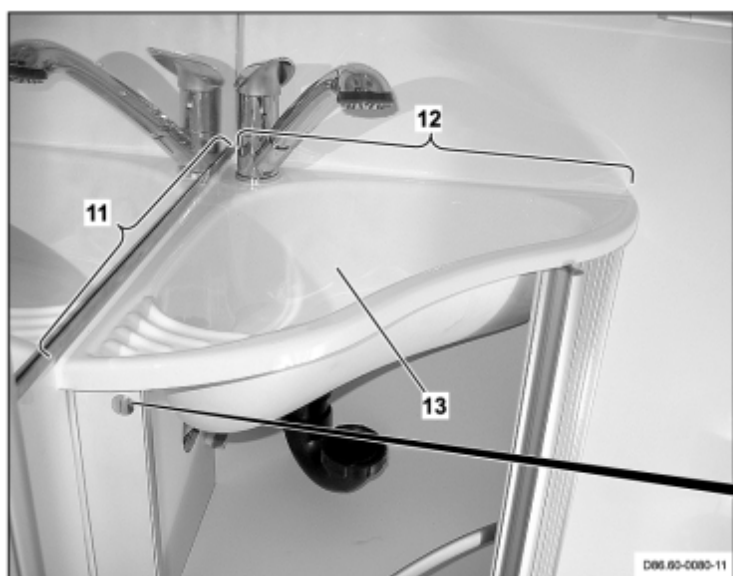







D86.60-0082-08

10 Nut
11 Range

12 Range

13 Wash basin

	Remove		
 Danger!	Risk of injury caused by scraping or cutting body parts on sharp vehicle parts	Always wear protective gloves when working on or near sharp and non-deburred vehicle parts. Deburr repair panels.	AS00.00-Z-0017-01B
 Danger!	Risk of injury caused by hot water exiting from the lines of the fresh water system	Shut off the water heater in a timely manner before starting repair work. Let the water in the lines and in the components of the fresh water system cool down to room temperature.	AS86.00-Z-0002-01A
1	Remove curtain (1)		
2	Slacken hose clamps (2)		
3	Disconnect hoses (3)	 Mark installation position of hoses (3)	
4	Pull off foam material (4)		
5	Disconnect electrical connector (5)		
6	Remove hose guides (6)		
7	Remove bolt (7)		
8	Remove sewer pipe (8)		
9	Unscrew screws (9)		

10	Unscrew nut (10)		
11	Cut sealing compound in areas (11, 12)		
12	Remove wash basin (13)		
	Install		
13	Prepare wash basin (13) for installation		AR86.60-D-0009-01A
14	Insert wash basin (13)		
15	Screw on nut (10)		
16	Screw in screws (9)		
17	Install sewer pipe (8)		
18	Screw in screw (7)		
19	Mask walls in sanitary cell with adhesive tape in areas (11, 12)		
20	Apply sealing compound in areas (11, 12)	 Use suitable sealing compound	
21	Install hose guides (6)		
22	Connect electrical connector (5)		
23	Install foam material (4)		
24	Connect hoses (3)	 Note installation positions of hoses (3)	
25	Tighten hose clamps (2)		
26	Install curtain (1)		
27	Check wastewater system for leakage		AR86.30-D-0071A
28	Check fresh water system for leakage		AR86.30-D-0065A

MODEL 903.662

with CODE (ZU8) National version for USA

with CODE (Z29) "James Cook" touring camper, NAFTA

1 Gas shut-off cocks



D86.60-0008-05

2 Sewer pipe

3 Hose clamps

4 and hoses

5 Electrical connector

6 Drawer

7 Connecting piece

8 Caps

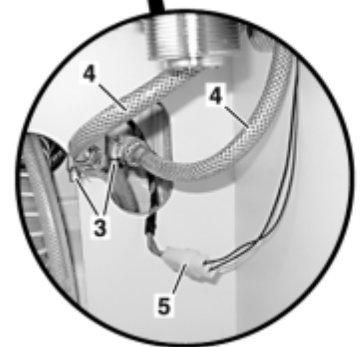
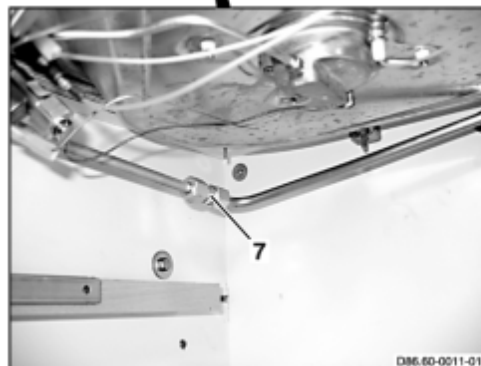
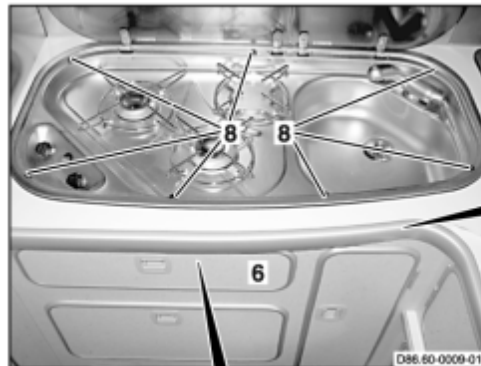

D86.60-0012-06

9 Bolts

10 Hot water heater/sink combination



D86.60-0013-11

	Remove/Install		
⚠ Danger!	Risk of injury caused by hot water exiting from the lines of the fresh water system	Shut off the water heater in a timely manner before starting repair work. Let the water in the lines and in the components of the fresh water system cool down to room temperature.	AS86.00-Z-0002-01A
⚠ Danger!	Risk of explosion caused by ignition of gas exiting the lines of the vehicle's gas system. Risk of injury caused by burns to skin and eyes.	Before commencing any work, ensure that all sources of ignition have been removed and that the gas system is completely emptied if necessary. Wear protective clothing.	AS86.00-Z-0004-01A
1	Close gas shut-off cocks (1)		
2	Remove sewer pipe (2)	Installation: Install new gasket	
3	Loosen hose clamps (3)		
4	Disconnect hoses (4)	Mark position of hoses (4)	
5	Disconnect electrical connector (5)		
6	Remove drawer (6)		AR86.60-D-0020A
7	Disconnect connecting element (7)		
8	Remove caps (8)		
9	Loosen screws (9)		

10	Remove boiler/sink combination (10)		
11	Install in the reverse order		
12	Check gas system for leakage		AR86.60-D-0100A
13	Check wastewater system for leakage		AR86.30-D-0071A
14	Check fresh water system for leakage		AR86.30-D-0065A

MODEL 903.662

with CODE (ZU8) National version for USA

with CODE (Z29) "James Cook" touring camper, NAFTA

1 Boiler/sink combination cover

2 Bolts

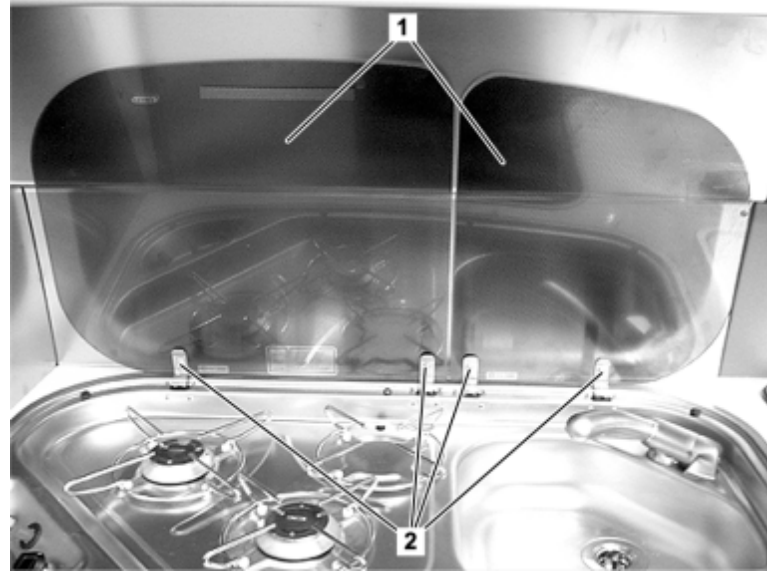

D86.60-0064-11

☒ ☒	Remove/Install		
1	Open cooker/sink combination covering (1)		
2	Remove screws (2)	<div data-bbox="824 1220 857 1262" style="border: 1px solid black; padding: 2px;">i</div> Only on boiler/sink combination covering (1) to be removed	
3	Remove boiler/sink combination covering (1)		
4	Install in the reverse order		

MODEL 903.662

with CODE (ZU8) National version for USA

with CODE (Z29) "James Cook" touring camper, NAFTA



1 Cooker/sink combination

2 Bolts

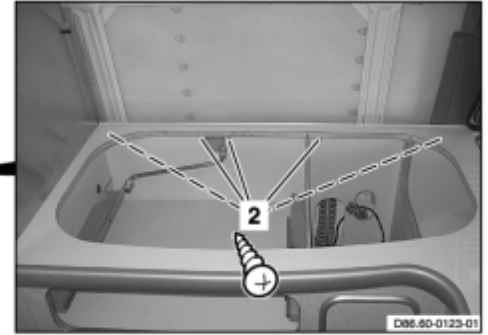
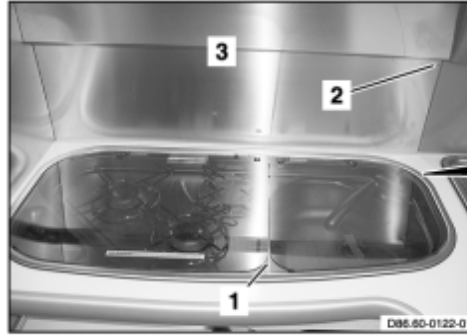
3 Heat shield



D86.60-0121-04

	Remove/Install		
 Danger!	Risk of injury caused by scraping or cutting body parts on sharp vehicle parts	Always wear protective gloves when working on or near sharp and undeurred vehicle parts. Deburr replacement panels.	AS00.00-Z-0017-01B
 Danger!	Risk of injury to skin and eyes caused by handling hot or glowing objects. Risk of fire when glowing objects come into contact with flammable materials.	Wear safety gloves, protective clothing and safety glasses, if necessary. Avoid contact of combustible materials with glowing objects	AS00.00-Z-0026-01A
1	Remove cooker/sink combination (1)		AR86.60-D-0010A
2	Unscrew bolts (2)		
3	Remove heat shield (3)		
4	Install in the reverse order		

MODEL 903.662

with CODE (ZU8) National version for USA

with CODE (Z29) "James Cook" touring camper, NAFTA

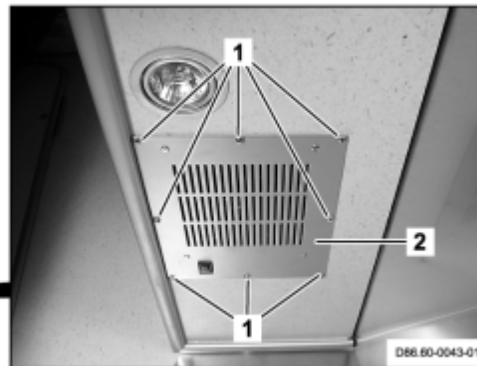
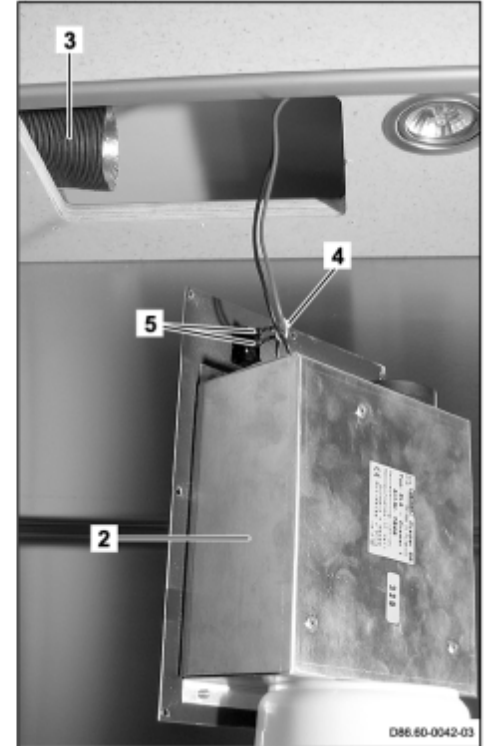
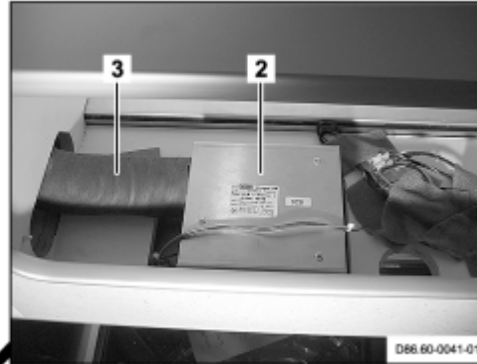

D86.60-0044-09

1 Bolts
2 Range hood

3 Bleed hose
4 Tie strap

5 Electrical connectors

	Remove/Install		
Danger!	Risk of injury caused by scraping or cutting body parts on sharp vehicle parts	Always wear protective gloves when working on or near sharp and non-deburred vehicle parts. Deburr repair panels.	AS00.00-Z-0017-01B
1	Remove floor	Lengthwise in hanging cabinet	AR86.60-D-0050-01A
2	Remove bolts (1)		
3	Remove range hood (2) downward	While doing this, remove bleed hose (3) from range hood (2)	
4	Cut open tie strap (4)	Installation: Use new tie strap (4).	

5	Disconnect electrical connectors (5) from range hood switch (2)		
6	Install in the reverse order		
7	Perform a function test	i Switch on range hood (2) (see operating instructions).	

MODEL 903.662

with CODE (ZU8) National version for USA

with CODE (Z29) "James Cook" touring camper, NAFTA

- 1 Bolts
 2 Forced ventilation, bottom section
 3 Forced ventilation, top section
 4 Gasket

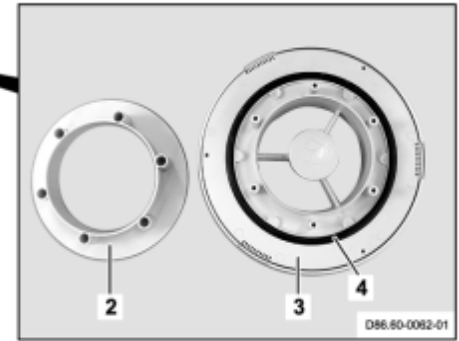

D86.60-0063-04

☒ ☒	Remove/Install		
⚠ Danger!	Risk of death caused by falling down from the roof of the vehicle. Risk of injury to other persons caused by falling objects during work in the area of the roof.	Work on or in the area of the vehicle's roof may only be performed on suitable equipment (ladders, scaffolds, lifting platforms). Sufficiently secure the area to be worked in.	AS65.00-Z-0002-01B
1	Remove bolts (1)		
2	Remove forced ventilation bottom section (2)		
3	Remove forced ventilation top section (3) from outside	i Installation: Ensure that seal (4) in good condition and seated correctly.	
4	Install in the reverse order		

MODEL 903.662

with CODE (ZU8) National version for USA

with CODE (Z29) "James Cook" touring camper, NAFTA

- 1 Bolts
 2 Range hood ventilation, bottom section
 3 Range hood ventilation, top section
 4 Butyl tape

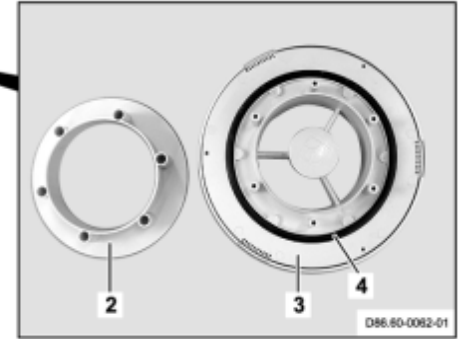

D86.60-0063-04

	Remove/Install		
	Danger! Risk of death caused by falling from vehicle roof. Risk of injury to other persons caused by falling objects during work in roof area.	Perform work on and in area of vehicle roof only with suitable aids (ladders, scaffolding, assembly platforms) Sufficiently secure working area	AS65.00-Z-0002-01B
1	Remove screws (1)		
2	Remove range hood ventilation bottom section (2)		
3	Separate butyl cord		110 589 03 59 00
		Butyl tape	BR00.45-Z-1067-01A
4	Unclip range hood ventilation top section (3) and remove		
5	Install in the reverse order		



110 589 03 59 00

Mounting wedge

Auxiliary repair materials

Number	Designation	Order number
BR00.45-Z-1067-01A	12 x 1.5 mm butyl strip	170 795 11 98

MODEL 903.662

with CODE (ZU8) Version for USA

with CODE (Z29) "James Cook" touring camper, NAFTA



1 Drawer

2 Hot water heater/sink
combination

3 Bolts



D86.60-0024-06

 	Remove/Install		
1	Open drawer (1) below hot water heater/sink combination (2)		
2	Unscrew bolts (3) in drawer (1) on both sides	 Installation: Screw in bolts (3) until resistance can be felt	
3	Move drawer (1) out of drawer rails toward front		
4	Install in the reverse order		
5	Check drawer (1) for easy motion when opening and closing		

MODEL 903.662

with CODE (ZU8) National version for USA

with CODE (Z29) "James Cook" touring camper, NAFTA

- 1 Drawer
2 Bolts
3 Drawers rail
4 Arrow

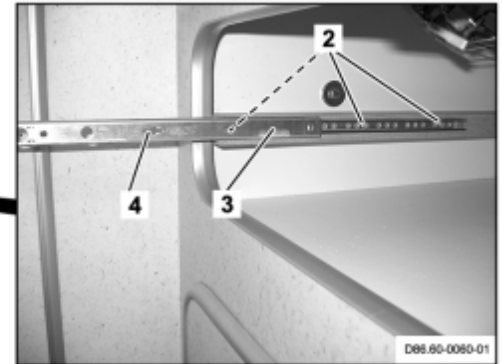

D86.60-0058-05

☒ ☒	Remove/Install		
⚠ Danger!	Risk of injury caused by scraping or cutting body parts on sharp vehicle parts	Always wear protective gloves when working on or near sharp and non-deburred vehicle parts. Deburr repair panels.	AS00.00-Z-0017-01B
1	Remove drawer (1)		AR86.60-D-0020A
2	Unscrew bolts (2) from drawer rail (3)	i Adjust drawer rail (3) until bolts (2) are accessible.	
3	Remove drawers rail (3)	i Installation: Observe direction of installation. Arrow (4) on drawer rail (3).	
4	Install in the reverse order		

MODEL 903.662

with CODE (ZU8) National version for USA

with CODE (Z29) "James Cook" touring camper, NAFTA



1 Drip pan

2 Bolts

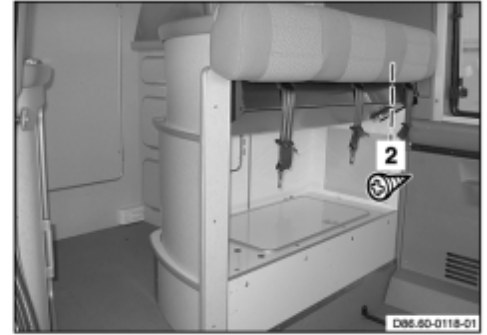
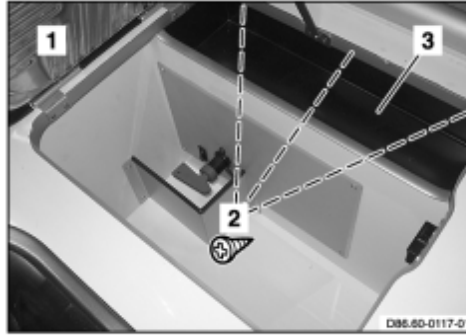
3 Utensil insert



D86.60-0116-04

 	Remove/Install		
1	Unlock bench seat and slide toward front		
2	Open drip pan (1)		
3	Unscrew bolts (2)		
4	Remove utensil insert (3)		
5	Install in the reverse order		

MODEL 903.662

with CODE (ZU8) National version for USA

with CODE (Z29) "James Cook" touring camper, NAFTA

1 Drawer/flap

2 Bolts

3 Lock

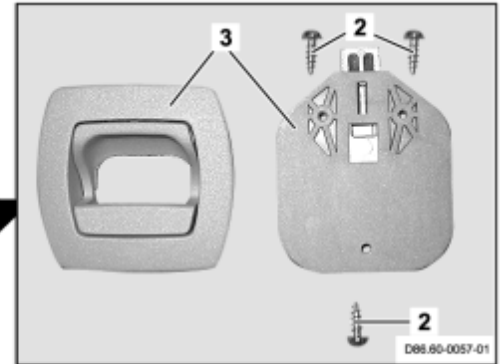
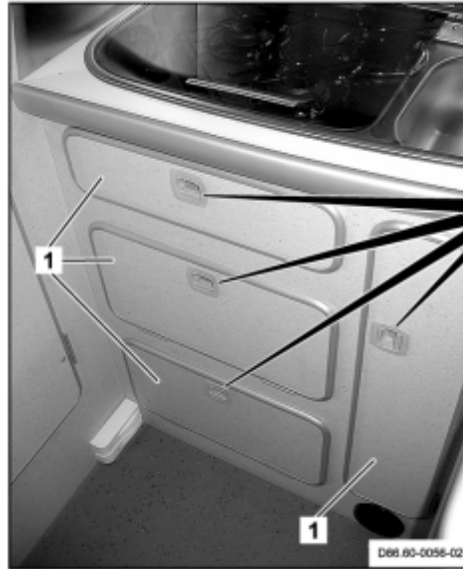

D86.60-0055-05

☒ ☒	Remove/Install		
1	Open drawer/flap (1)		
2	Unscrew bolts (2) from lock (3)		
3	Remove lock (3)		
4	Install in the reverse order		
5	Operational check	If necessary, adjust lock (3)	

MODEL 903.662

with CODE (ZU8) National version for USA

with CODE (Z29) "James Cook" touring camper, NAFTA

Shown on longitudinal hanging cabinet

1 Retractable cover

2 Bolts

3 Handle

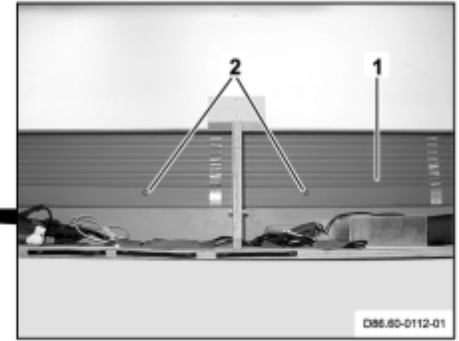
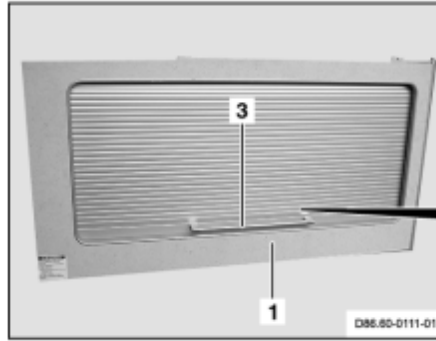

D86.60-0113-04

☒ ☒	Remove/Install		
⚠ Danger!	Injury hazard from doors, covers, flaps or loose components pinching or cutting off extremities.	No body parts should be within the motion area when moving doors, covers, flaps and components. Always wear protective gloves	AS00.00-Z-0025-01A
1	Open retractable cover (1)	ⓘ Until screws (2) are accessible.	
2	Unscrew bolts (2)		
3	Remove handle (3)		
4	Install in the reverse order		

MODEL 903.662

with CODE (ZU8) National version for USA

with CODE (Z29) "James Cook" touring camper, NAFTA

Cooling box storage cabinet

- 1 Bolts
- 2 Latch plate
- 3 Bolts
- 4 Latch

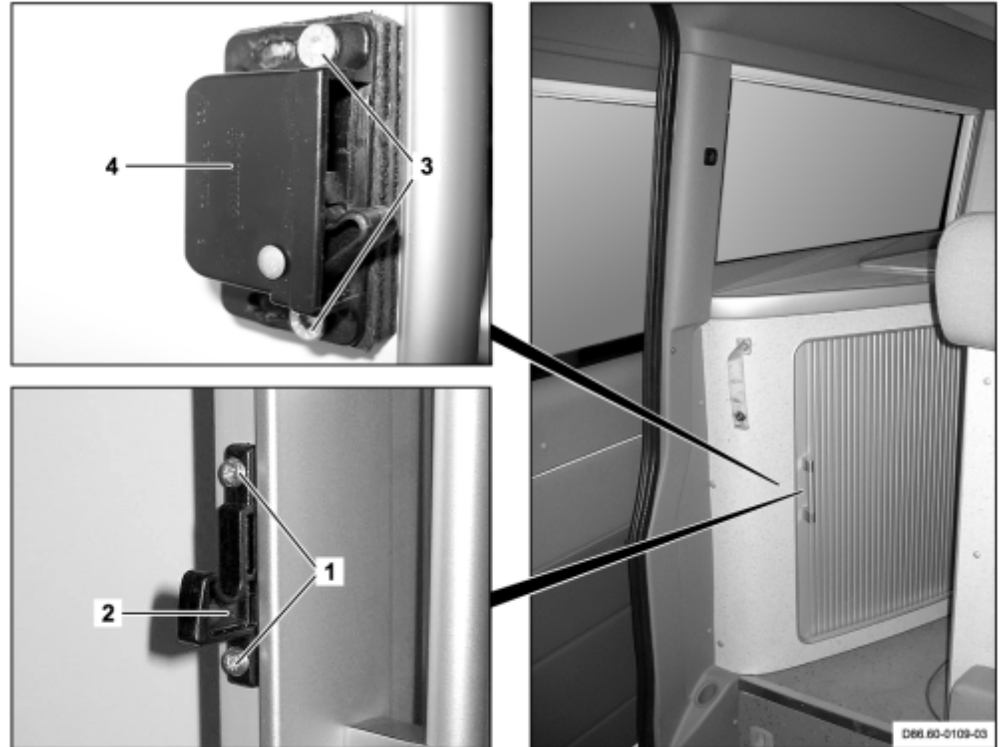

D86.60-0110-06

☒ ☒	Remove/Install		
1	Open retractable cover		
2	Remove screws (1)		
3	Remove latch plate (2)	i Installation: Observe installation position of latch plate (2)	
4	Remove bolts (3)		
5	Remove latch (4)	i Installation: Observe installation position of latch (4)	
6	Install in the reverse order		
7	Check whether latch locks and unlocks properly		

MODEL 903.662

with CODE (ZU8) National version for USA

with CODE (Z29) "James Cook" touring camper, NAFTA

1 Wash basin

2 Retractable cover

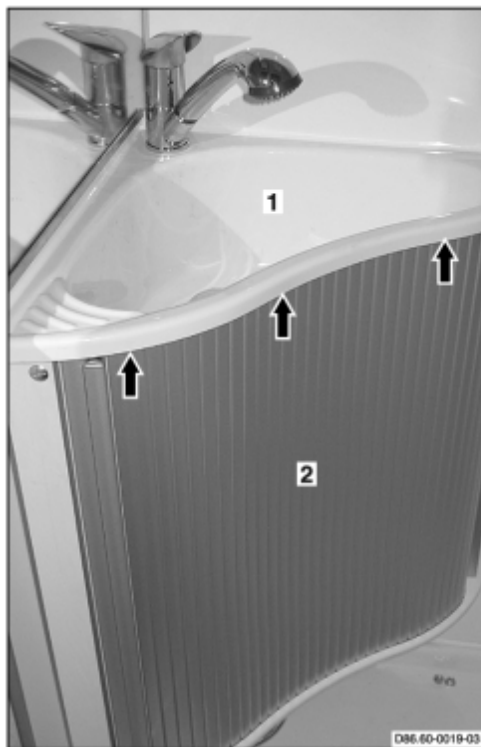

D86.60-0021-06

☒ ☒	Remove/Install		
⚠ Danger!	Risk of injury caused by body parts becoming jammed, pinched or severed by doors, covers, flaps or by loose components	Keep body parts well clear when moving doors, covers, flaps and components. Wear protective gloves and protective shoes.	AS00.00-Z-0025-01A
1	Slightly raise wash basin (1) in direction of arrow		
2	Guide retractable cover (2) out of guides		
3	Install in the reverse order		
4	Check retractable cover for easy motion (2)		

MODEL 903.662

with CODE (ZU8) National version for USA

with CODE (Z29) "James Cook" touring camper, NAFTA

Cooling box stowage cabinet

1 Stowage cabinet

2 Nuts

3 Bolts

4 Mounting bracket

5 Retractable cover

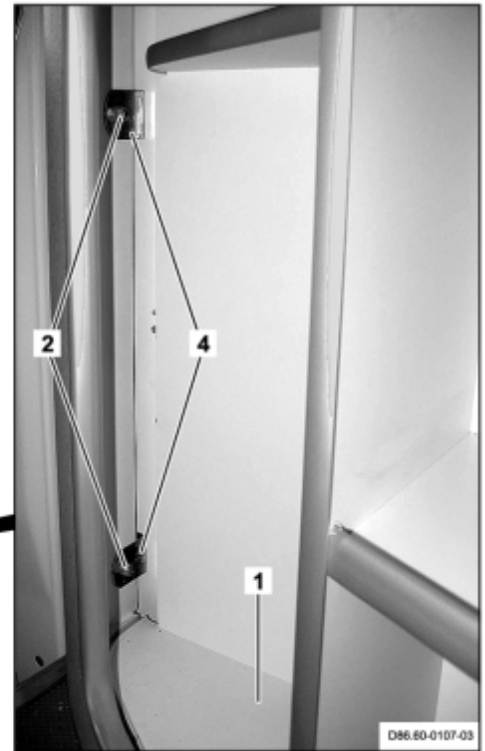
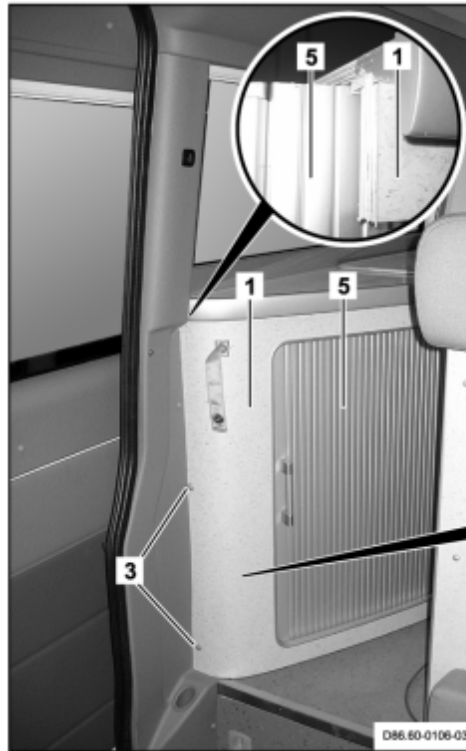

D86.60-0108-06

☒ ☒	Remove/Install		
⚠ Danger!	Injury hazard from doors, covers, flaps or loose components pinching or cutting off extremities.	No body parts should be within the motion area when moving doors, covers, flaps and components. Always wear protective gloves	AS00.00-Z-0025-01A
1	Remove stowage cabinet (1)	Refrigerator box	AR86.60-D-0045A
		i Only loosen and pull away from side wall of vehicle until sufficient space is present for extending the retractable cover (5) from the stowage cabinet (1).	
2	Unscrew nuts (2)		
3	Remove screws (3)		

4	Remove mounting bracket (4)		
5	Remove lock on retractable cover (5) and from stowage cabinet (1)		AR86.60-D-0028A
6	Remove handle from retractable cover (5)		AR86.60-D-0027A
7	Move retractable cover (5) out of stowage cabinet (1)		
8	Install in the reverse order		

MODEL 903.662

with CODE (ZU8) National version for USA

with CODE (Z29) "James Cook" touring camper, NAFTA

Longitudinal hanging cabinet

1 Longitudinal hanging cabinet

2 Bolts

3 Stop

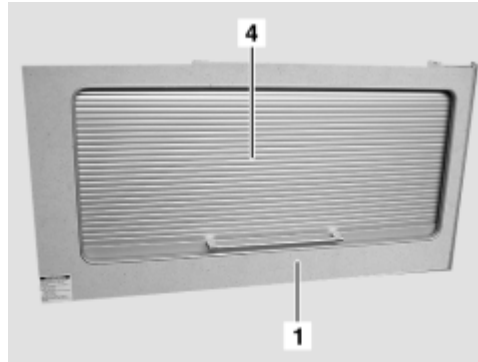

4 Retractable cover

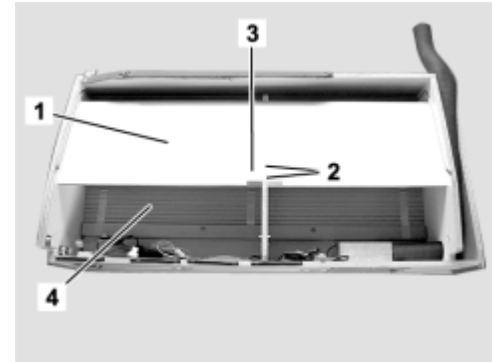

D86.60-0114-01



D86.60-0115-01

	Remove/Install		
 Danger!	Injury hazard from doors, covers, flaps or loose components pinching or cutting off extremities.	No body parts should be within the motion area when moving doors, covers, flaps and components. Always wear protective gloves	AS00.00-Z-0025-01A
1	Remove longitudinal hanging cabinet (1)		AR86.60-D-0051B
2	Remove handle from retractable cover (4)		AR86.60-D-0027A
3	Unscrew bolts (2)		
4	Remove stop (3)		
5	Move retractable cover (4) out of longitudinal hanging cabinet (1)		
6	Install in the reverse order		

MODEL 903.662

with CODE (ZU8) Version for USA

with CODE (Z29) "James Cook" touring camper, NAFTA

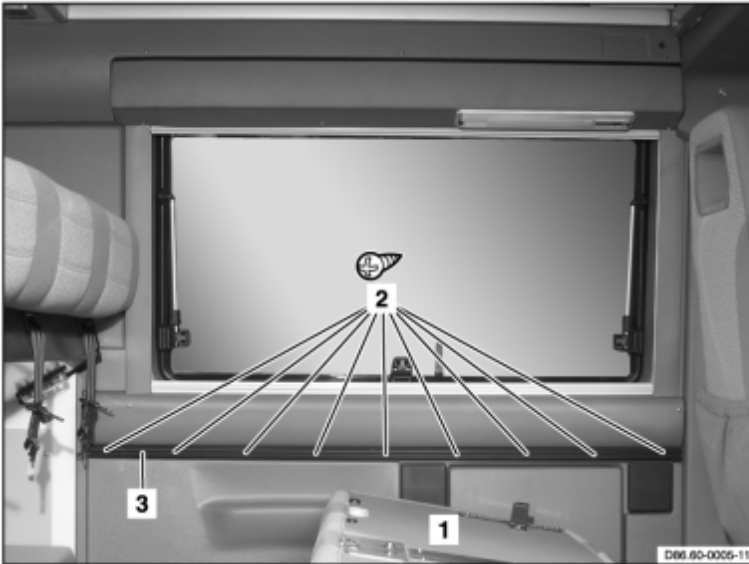

D86.60-0006-08

1 Backrest

2 Bolts

3 Fastening strip

	Remove/Install		
1	Fold back bench seat backrest (1)		
2	Remove bolts (2)		
3	Remove fastening strip (3)		
4	Install in the reverse order		

MODEL 903.662

with CODE (ZU8) National version for USA

with CODE (Z29) "James Cook" touring camper, NAFTA refrigerator box

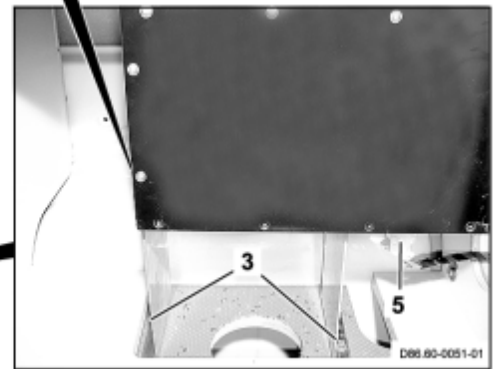
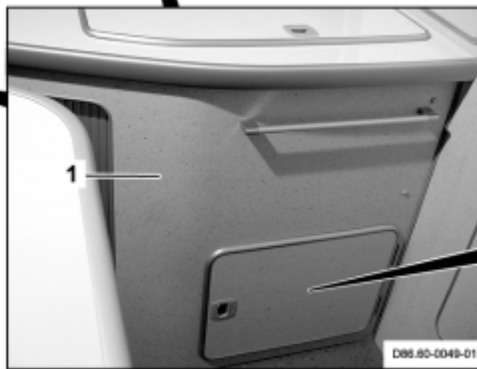
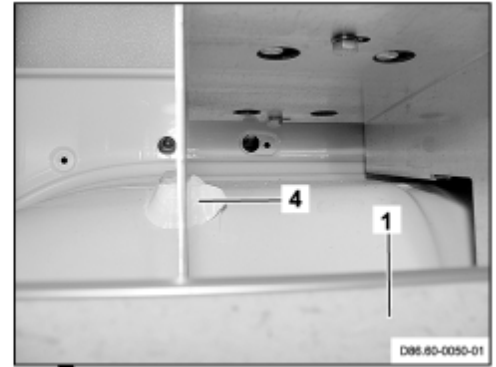
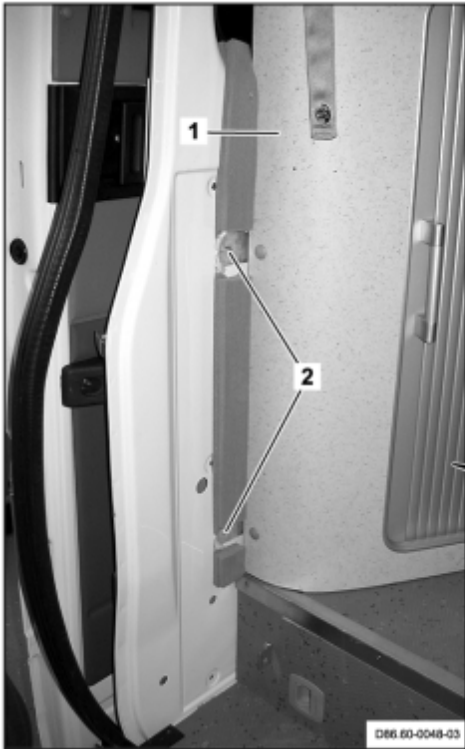

D86.60-0052-09

1 Stowage cabinet
2 Bolts

3 Bolts
4 Adhesive









5 Electrical connector

6 Bolts



D86.60-0054-04

	<p>Remove/Install</p>		
<p>⚠ Danger!</p>	<p>Risk of injury caused by scraping or cutting body parts on sharp vehicle parts</p>	<p>Always wear protective gloves when working on or near sharp and non-deburred vehicle parts.</p>	<p>AS00.00-Z-0017-01B</p>

		Deburr repair panels.	
 Danger!	Risk of injury caused by body parts becoming jammed, pinched or severed by doors, covers, flaps or by loose components	Keep body parts well clear when moving doors, covers, flaps and components. Wear protective gloves and protective shoes.	AS00.00-Z-0025-01A
1	Switch off refrigerator box	 See Operator's Manual	
2	Remove moldings from C-pillar	Right side	AR68.30-D-4490A
3	Remove foam material seal in area of bolts (2)	 Installation: Use new foam material.	
4	Unscrew bolts (2)		
5	Remove refrigerator box cover		AR86.61-D-1003A
6	Remove bolts (3)		
7	Cut adhesive (4)	 Installation: Use suitable adhesive	
8	Disconnect electrical connector (5) from refrigerator box		
9	Unscrew bolts (6)		
10	Remove stowage cabinet (1)	 Cover interior equipment to prevent damaging the vehicle interior equipment by the stowage cabinet (1).	
		 Several helpers required	
		 Lift stowage compartment (1) over kitchen cabinet	
11	Install in the reverse order		
12	Perform a function test	 Switch on refrigerator box (see operating instructions)	

MODEL 903.662

with CODE (ZU8) National version for USA

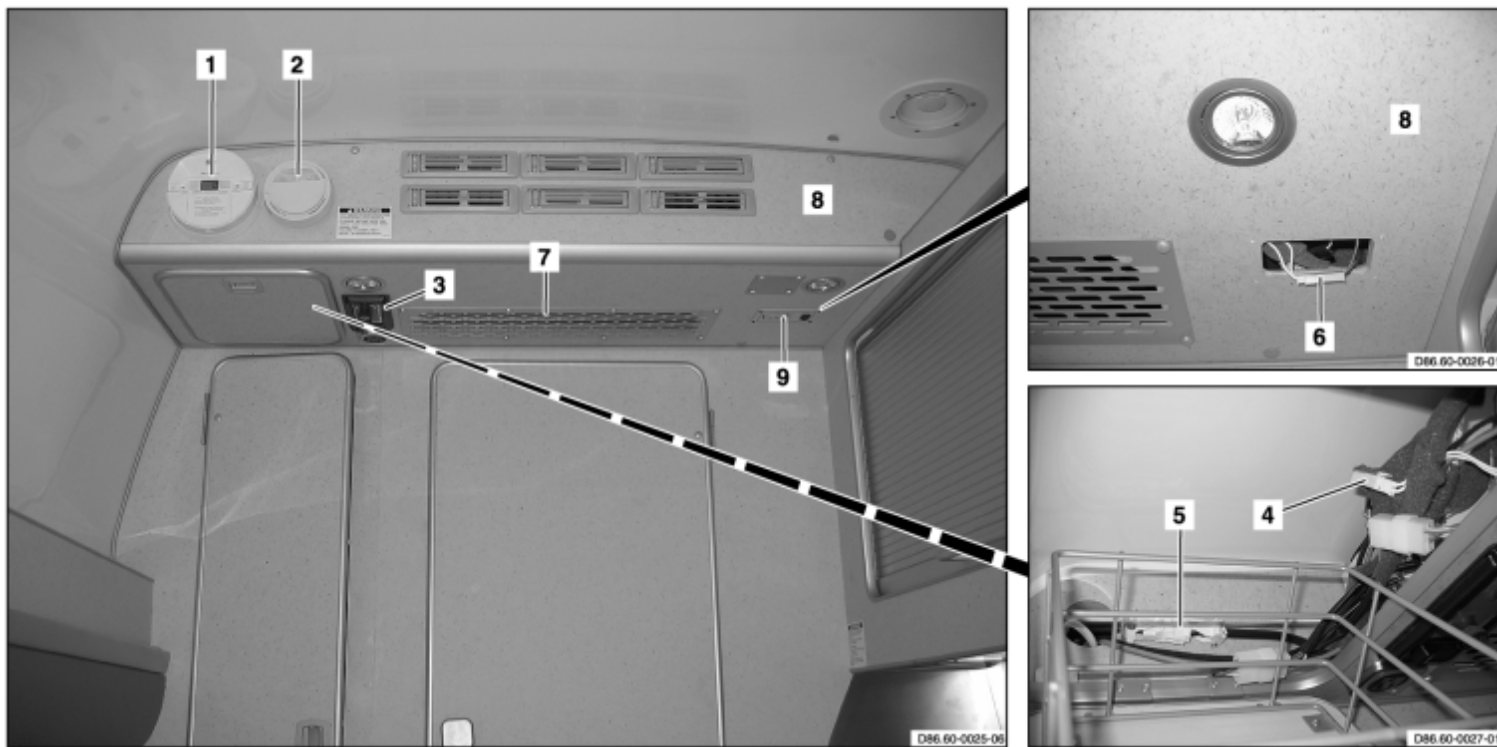
with CODE (Z29) "James Cook" touring camper, NAFTA
lateral hanging cabinet









D86.60-0028-09

1 CO sensor
2 Smoke sensor
3 Operating console

4 Electrical connector
5 Electrical connector
6 Electrical connector

7 Vent grille
8 Hanging cabinet
9 Excrement tank fill level
indicator

☒ ☒	Remove/Install		
⚠ Danger!	Risk of injury caused by body parts becoming jammed, pinched or severed by doors, covers, flaps or by loose components	Keep body parts well clear when moving doors, covers, flaps and components. Wear protective gloves and protective shoes.	AS00.00-Z-0025-01A
⚠ Danger!	Risk of death from coming into contact with electrical parts of the 110 V system Risk of injury caused by burns, which can be produced by electrical shocks or by body parts coming in direct contact with electrical currents.	Do not touch any conductive parts of the 110 V system.	AS00.00-Z-0027-01A

1	Switch off roof air conditioning	 See Operator's Manual	
2	Remove CO sensor (1)		AR54.65-D-0010A
3	Remove smoke sensor (2)		AR54.65-D-0009A
4	Remove cover paneling in hanging cabinet (8)	On right side	AR86.60-D-0051-01A
5	Remove cover paneling in hanging cabinet (8)	Right rear	AR86.60-D-0051-01B
6	Remove control console (3)	Roof air conditioning	AR83.50-D-6040A
7	Disconnect electrical connector (4) from right interior illumination		
8	Disconnect electrical connector (15) from 110-V socket		
9	Remove excrement tank fill level indicator (9)		AR54.30-D-6350A
10	Disconnect electrical connector (6) from left interior illumination	 Through free opening in excrement tank fill level indicator (9).	
11	Remove vent grille (7)	On lateral hanging cabinet	AR83.10-D-0011A
12	Loosen hanging cabinet (8)	Lateral hanging cabinet	AR86.60-D-0051-02A
		 Helper required.	
13	Remove all electrical lines from lateral hanging cabinet (8)	 Helper required.	
14	Completely lower lateral hanging cabinet (8) at rear	 Helper required.	
15	Remove hanging cabinet (8)	 Helper required.	
		 Avoid damage by canting lateral hanging cabinet (8)	
16	Install in the reverse order		
17	Perform function check	 All electrical components on lateral hanging cabinet (8).	

MODEL 903.662

with CODE (ZU8) National version for USA

with CODE (Z29) "James Cook" touring camper, NAFTA

Longitudinal hanging cabinet

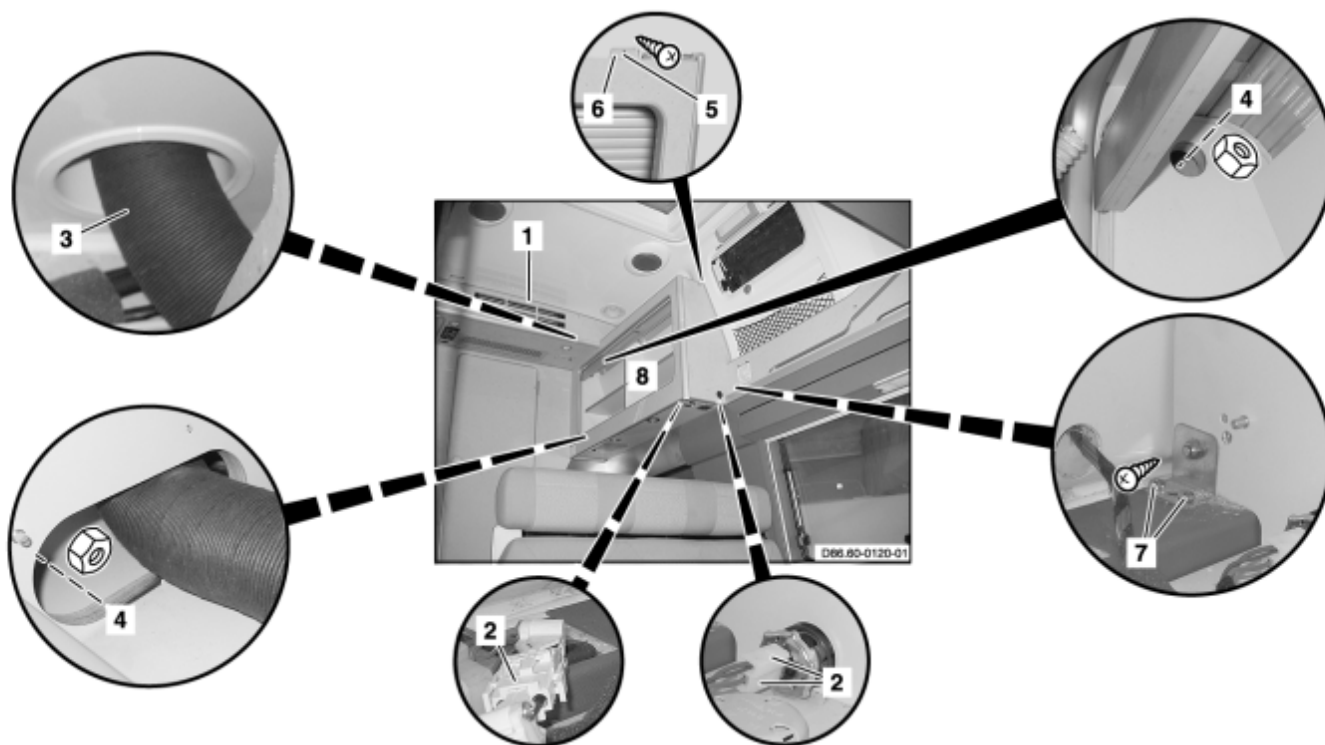

D86.60-0119-09

1 Hanging cabinet
 2 Electrical connectors
 3 Range hood bleed hose

4 Nuts
 5 Screw
 6 Bracket

7 Bolts
 8 Hanging cabinet

☒ ☒	Remove/Install		
⚠ Danger!	Injury hazard from doors, covers, flaps or loose components pinching or cutting off extremities	No body parts should be within the motion area when moving doors, covers, flaps and components Always wear protective gloves	AS00.00-Z-0025-01A
⚠ Danger!	Risk of death from coming into contact with electrical parts of the 110 V system Injury hazard from burns caused by an electric shock or direct power flow through body parts	Do not touch voltage conducting parts in the 110 V system.	AS00.00-Z-0027-01A
1	Remove hanging cabinet (1)	Lateral hanging cabinet	AR86.60-D-

			0051A
2	Remove floor in hanging cabinet (8)		AR86.60-D-0050-01A
3	Disconnect electrical connectors (2).		
4	Remove range hood bleed hose (3)		
5	Unscrew nuts (4)		
6	Unscrew bolt (5) from bracket (6)		
7	Unscrew bolts (7).		
8	Remove hanging cabinet (8)	i Helper required	
9	Install in the reverse order		

MODEL 903.662

with CODE (ZU8) National version for USA

with CODE (Z29) "James Cook" touring camper, NAFTA



D86.60-0156-09

1 Bolts

2 Storage shelf

3 Screw

☒ ☒	Remove/Install		
⚠ Danger!	Injury hazard from doors, covers, flaps or loose components pinching or cutting off extremities	No body parts should be within the motion area when moving doors, covers, flaps and components Always wear protective gloves	AS00.00-Z-0025-01A
1	Remove wardrobe flap	Front flap	AR86.60-D-0062A
2	Remove clothes rail in wardrobe		AR86.60-D-0063A
3	Remove caps from bolts (1)		
4	Remove screws (1)		
5	Remove wardrobe flap	Rear flap	AR86.60-D-0062B

6	Remove bolt (3)		
7	Mask frame of rear opening of wardrobe with adhesive tape		
8	Pull storage shelf (2) toward center (arrow)		
9	Tilt storage shelf (2)		
10	Remove storage shelf (2) from wardrobe		
11	Install in the reverse order		

MODEL 903.662

with CODE (ZU8) National version for USA

with CODE (Z29) "James Cook" touring camper, NAFTA

Front flap

1 Bolts
2 Flap

D86.60-0153-06

	Remove/Install		
Danger!	Injury hazard from doors, covers, flaps or loose components pinching or cutting off extremities	No body parts should be within the motion area when moving doors, covers, flaps and components Always wear protective gloves	AS00.00-Z-0025-01A
1	Remove screws (1)		
2	Remove flap (2) with hinges		
3	Install in the reverse order		

MODEL 903.662
 with CODE (ZU8) National version for USA
 with CODE (Z29) "James Cook" touring camper, NAFTA
 Rear flap

1 Bolts
 2 Flap

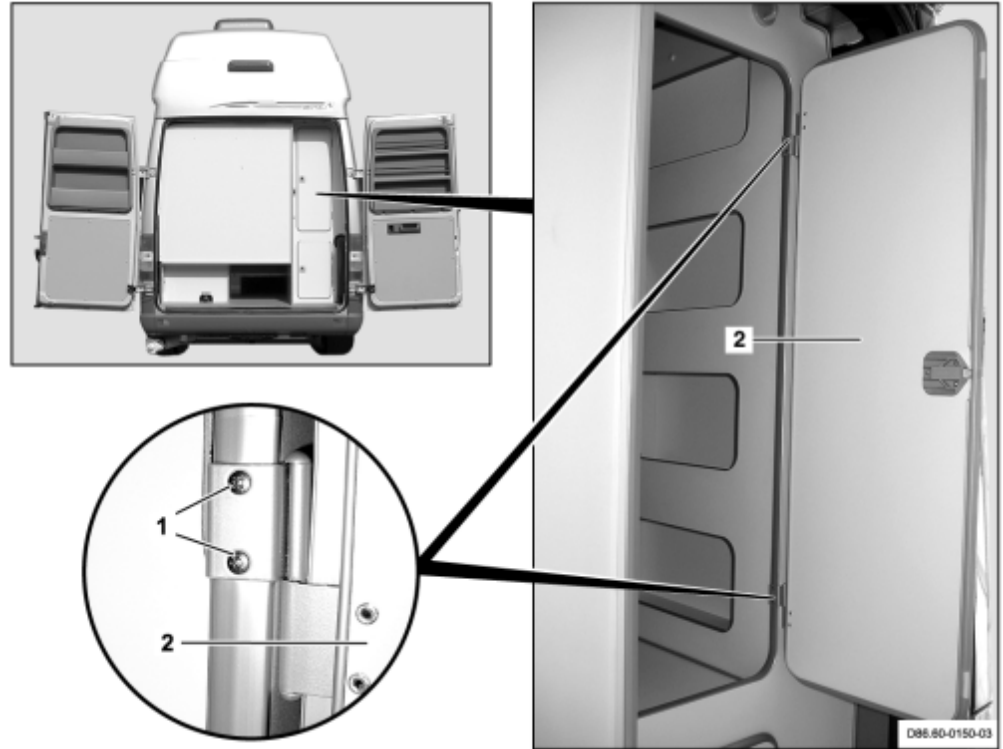

D86.60-0151-06

	<p>Remove/Install</p>		
<p>Danger!</p>	<p>Injury hazard from doors, covers, flaps or loose components pinching or cutting off extremities</p>	<p>No body parts should be within the motion area when moving doors, covers, flaps and components Always wear protective gloves</p>	<p>AS00.00-Z-0025-01A</p>
<p>1</p>	<p>Remove screws (1)</p>		
<p>2</p>	<p>Remove flap (2) with hinges</p>		
<p>3</p>	<p>Install in the reverse order</p>		

MODEL 903.662

with CODE (ZU8) National version for USA

with CODE (Z29) "James Cook" touring camper, NAFTA

1 Nut

2 Screw

3 Clothes rail

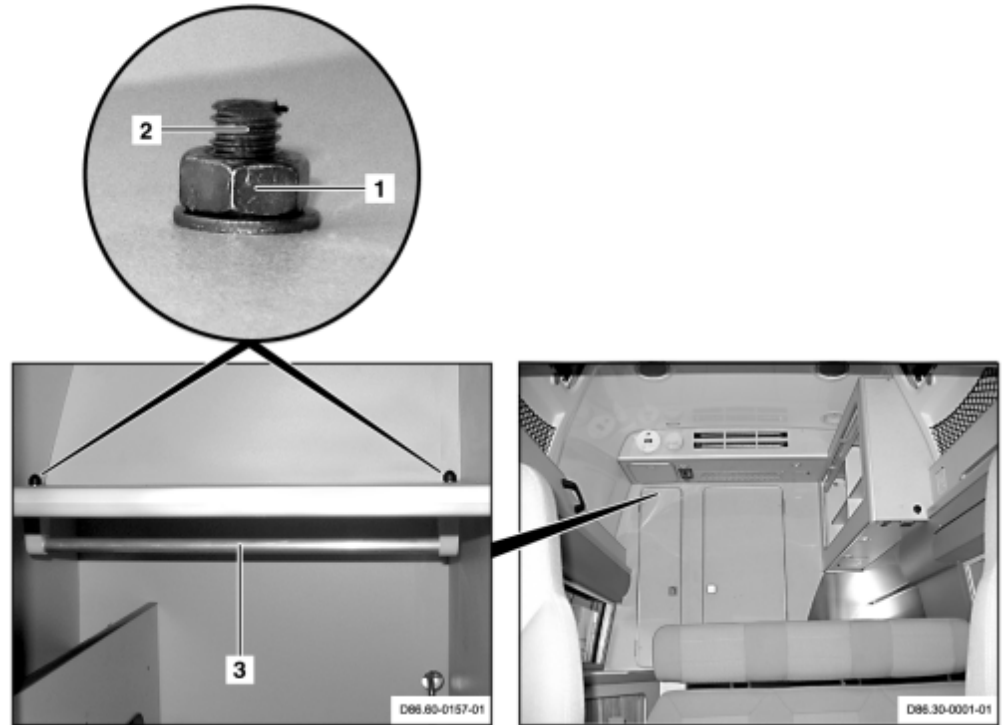

D86.60-0158-06

☒ ☒	Remove/Install		
1	Remove cap from nut (1)		
2	Unscrew nut (1)		
3	Remove clothes rail (3) with bolt (2)		
4	Install in the reverse order		

MODEL 903.662

with CODE (ZU8) National version for USA

with CODE (Z29) "James Cook" touring camper, NAFTA

1 Hot water heater/sink combination

2 Water tap



D86.60-0104-01

1 Hot water heater/sink combination

2 Water tap

3 Nut

4 Gasket

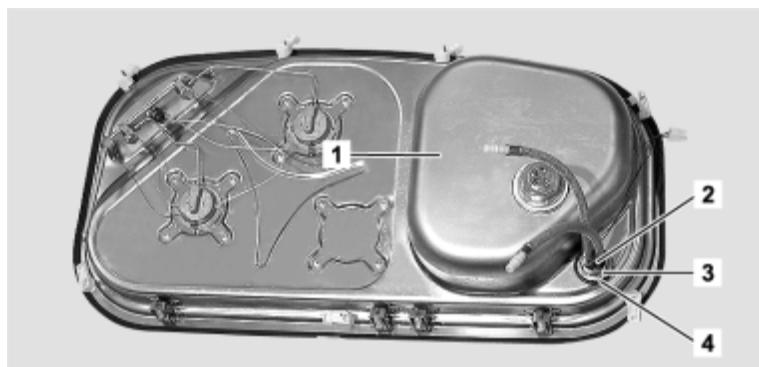

D86.60-0105-10

☒ ☒	Remove/Install		
⚠ Danger!	Risk of injury caused by hot water exiting from the lines of the fresh water system	Shut off the water heater in a timely manner before starting repair work. Let the water in the lines and in the components of the fresh water system cool down to room temperature.	AS86.00-Z-0002-01A
⚠ Danger!	Risk of explosion caused by ignition of gas exiting the lines of the vehicle's gas system. Risk of injury caused by burns to skin and eyes.	Before commencing any work, ensure that all sources of ignition have been removed and that the gas system is completely emptied if necessary. Wear protective clothing.	AS86.00-Z-0004-01A
1	Remove hot water heater/sink combination (1)		AR86.60-D-0010A
2	Unscrew nut (3)		

3	Remove gasket (4)	i Installation: Check gasket (4) for damage, replace if necessary	
4	Remove water tap (2) from hot water heater/sink combination (1)		
5	Install in the reverse order		
6	Perform a function test	i Open water tap (2), close	
7	Check gas system for leakage		AR86.60-D-0100A
8	Check wastewater system for leakage		AR86.30-D-0071A
9	Check fresh water system for leakage		AR86.30-D-0065A

MODEL 903.662

with CODE (ZU8) Version for USA

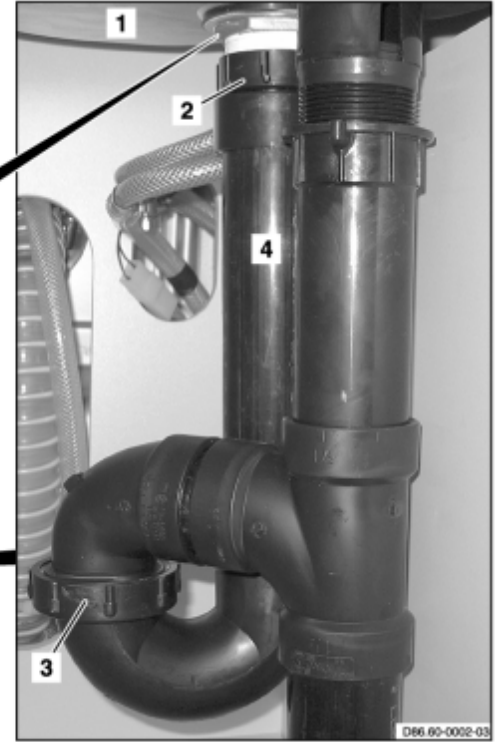
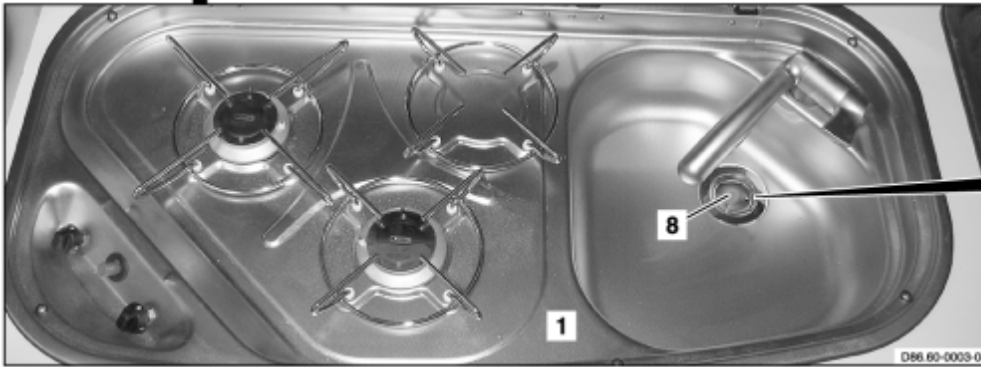
with CODE (Z29) "James Cook" touring camper, NAFTA
hot water heater/sink combination

D86.60-0004-09

1 Hot water heater/sink
combination

2 Bolted connection

3 Bolted connection





4 Downpipe

5 Nut

6 Paper gasket

7 Rubber seal

8 Syphon

	Remove/Install		
1	Loosen bolts (2)		
2	Loosen bolts (3)		
3	Remove downpipe (4)		
4	Unscrew nut (5)	 Hold syphon (8) with suitable tool at top.	
5	Remove paper seal (6)	 Installation: Replace paper seal (6)	
6	Remove rubber seal (7)	 Installation: Check rubber seal (7) for damage, replace if	

		necessary	
7	Remove syphon (8) from hot water heater/sink combination		
8	Install in the reverse order		
9	Perform leak check	i Open cock, check syphon (8) and bolts (2, 3) on downpipe (4) for leakage	

MODEL 903.662

with CODE (ZU8) Version for USA

with CODE (Z29) "James Cook" touring camper, NAFTA

- 1 Strainer
- 2 Waste trap



D86.60-0014-01

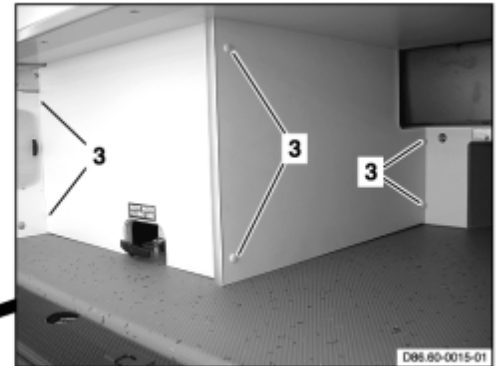

D86.60-0015-01

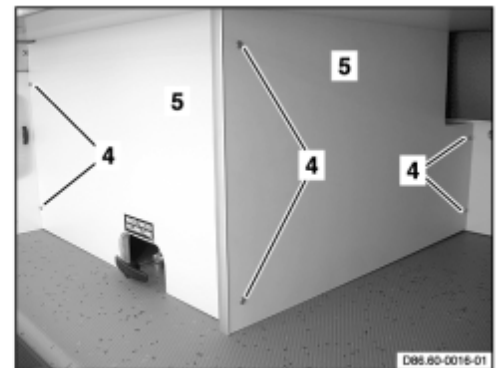

D86.60-0016-01

D86.60-0017-09

3 Caps







4 Bolts

5 Covers

- 6 Downpipe
- 7 Nut



D86.60-0018-11

	Remove		
1	Remove strainer (1) from waste trap (2)		
2	Remove caps (3)		
3	Remove bolts (4)		
4	Remove covers (5)		
5	Unscrew downpipe (6) as far as possible		
6	Unscrew nut (7)	 Helper must hold waste trap (2) in sanitary block with suitable tool.	
7	Press waste trap (2) upward		
8	Unscrew downpipe (6)		
9	Unscrew nut (7)		
10	Remove waste trap (2)		
	Install		
11	Insert waste trap (2)	 Check seals for damage, replace if necessary	
12	Screw on nut (7)	 Screw on only half of thread	
13	Screw on downpipe (6)	 Check seals for damage, replace if necessary	
14	Tighten nut (7)	 Helper must hold waste trap (2) in sanitary block with suitable tool.	

15	Check downpipe (6) for leakage		
16	Insert covers (5)		
17	Screw in bolts (4)		
18	Position caps (3)		
19	Insert sieve (1)		

MODEL 903.662

with CODE (ZU8) National version for USA

with CODE (Z29) "James Cook" touring camper, NAFTA

- 1 Hose clamps
- 2 and hoses
- 3 Screw
- 4 Hose guide
- 5 Nut
- 6 Water tap
- 7 Sealing ring
- 8 Thread

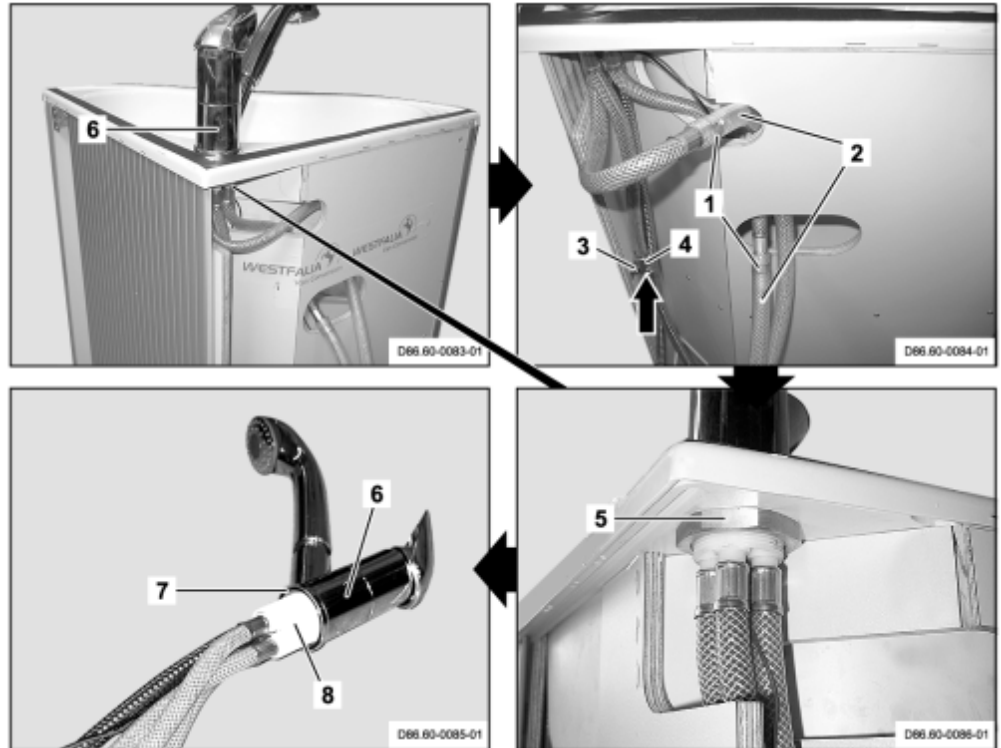

D86.60-0087-06

☒ ☒	Remove/Install		
⚠ Danger!	Risk of injury caused by hot water exiting from the lines of the fresh water system	Shut off the water heater in a timely manner before starting repair work. Let the water in the lines and in the components of the fresh water system cool down to room temperature.	AS86.00-Z-0002-01A
1	Remove wash basin in sanitary block		AR86.60-D-0009A
2	Slacken hose clamps (1)	i Installation: Replace hose clamps (1).	
3	Disconnect hoses (2)		
4	Remove bolt (3)		
5	Remove hose guide (4)		
6	Separate hose connection (arrow)	! Installation: Check hose	

		connection seal for damage, replace if necessary to prevent leakage	
7	Unscrew nut (5)		
8	Remove water tap (6)	 Installation: Check sealing ring (7) and thread (8) for damage, replace if necessary to prevent leakage	
9	Install in the reverse order		
10	Check water tap (6) for proper function		
11	Check fresh water system for proper function		AR86.30-D-0065A

MODEL 903.662

with CODE (ZU8) National version for USA

with CODE (Z29) "James Cook" touring camper, NAFTA

1 Gas line

2 Gas line

3 Gas line

4 Gas shut-off cock

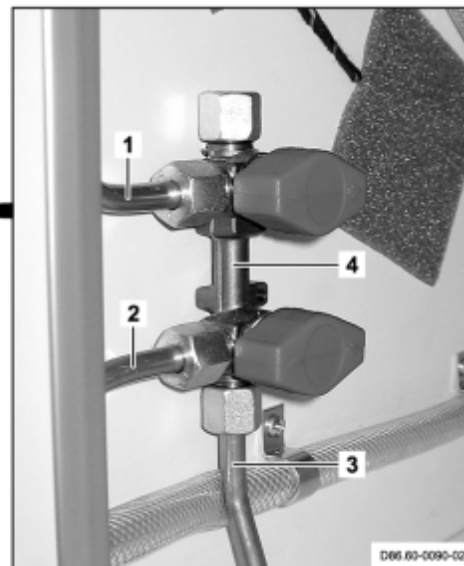







D86.60-0091-05

☒ ☒	Remove/install		
<p>⚠ Danger!</p>	<p>Risk of explosion caused by ignition of gas exiting the lines of the vehicle's gas system. Risk of injury caused by burns to skin and eyes.</p>	<p>Before commencing any work, ensure that all sources of ignition have been removed and that the gas system is completely emptied if necessary. Wear protective clothing.</p>	<p>AS86.00-Z-0004-01A</p>
1	Close main shut-off valve on compressed gas reservoir	<p>i See Operator's Manual</p>	
2	Unscrew gas lines (1, 2, 3) from gas shut-off valve (4)		
3	Remove gas shut-off valve (4)		
4	Install in the reverse order		
5	Perform leakage test for gas system		<p>AR86.60-D-0100A</p>

MODEL 903.662

with CODE (ZU8) National version for USA

with CODE (Z29) "James Cook" touring camper, NAFTA

	Check		
⚠ Danger!	Risk of explosion caused by ignition of gas exiting the lines of the vehicle's gas system. Risk of injury caused by burns to skin and eyes.	Before commencing any work, ensure that all sources of ignition have been removed and that the gas system is completely emptied if necessary. Wear protective clothing.	AS86.00-Z-0004-01A
1	Close valves on gas cooker and hot water boiler	 See Operator's Manual	
2	Fill compressed gas reservoir	 See Operator's Manual	
3	Open main shut-off valve on compressed gas reservoir	 See Operator's Manual	
4	Open shut-off valves for gas cooker and hot water boiler	 See Operator's Manual	
5	Spray gas lines, their connections and components of gas system with soapy water		
6	Check gas lines, connections and components of gas system for leakage	 If a sufficient quantity of soap solution is applied, bubbles are present at leaky points.	
7	Repair affected components or replace		
8	Repeat steps 1 to 6		

MODEL 903.662

with CODE (ZU8) National version for USA

with CODE (Z29) "James Cook" touring camper, NAFTA

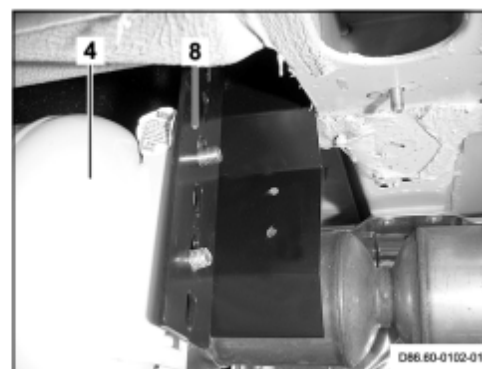
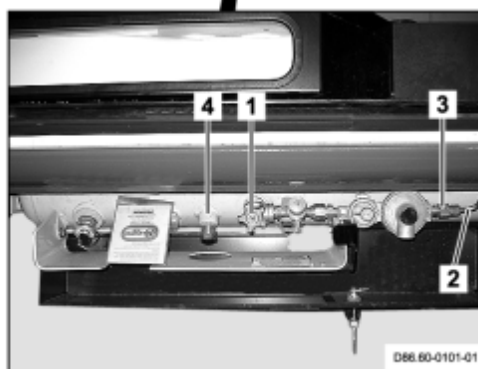
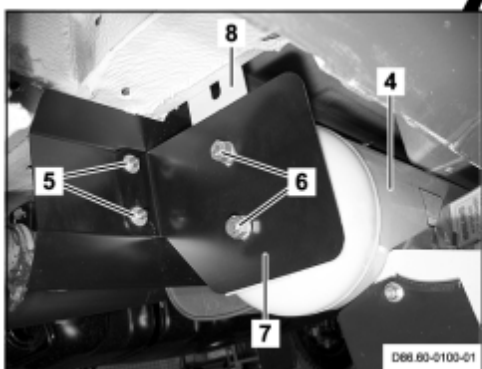
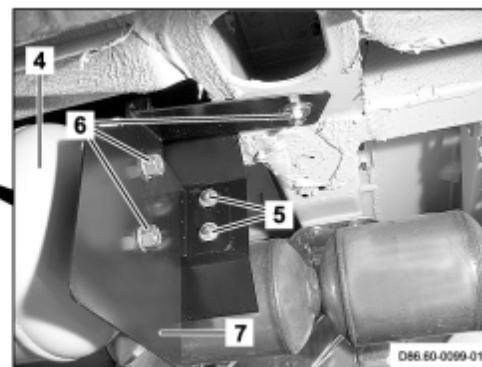

D86.60-0103-09

1 Main shut-off valve
2 Gas line
3 Reducer

4 Compressed-gas tank
5 Nuts
6 Nuts

7 Bracket
8 Bracket

☒ ☒	Remove/Install		
⚠ Danger!	Risk of explosion caused by ignition of gas exiting the lines of the vehicle's gas system. Risk of injury caused by burns to skin and eyes.	Before commencing any work, ensure that all sources of ignition have been removed and that the gas system is completely emptied if necessary. Wear protective clothing.	AS86.00-Z-0004-01A
ⓘ	Notes on self-locking nuts and bolts	All models	AH00.00-N-0001-01A
1	Drain compressed-gas tank (4)		
2	Close main shut-off valve (1) on compressed-gas tank (4)	ⓘ See Operator's Manual	
3	Disconnect gas line (2) from		

	reducer (3)		
4	Unscrew nuts (5) on both sides of compressed-gas tank (4)	i Installation: Replace self-locking nuts (5).	
5	Unscrew nuts (6) on both sides of compressed-gas tank (4)	i Installation: Before tightening nuts (6) align compressed-gas tank (4) with reducer (4) parallel to gas line (2)	
6	Remove bracket (7) on both sides of compressed-gas tank (4)		
7	Remove compressed-gas tank (4) from bracket (8) on both sides	i Helper required.	
		i When replacing compressed-gas tank (4) transfer following components: ↓	
		Remove/install cover for compressed-gas tank	AR86.60-D-0120A
		Remove/install fill level sensor for compressed-gas tank	AR86.60-D-0130A
		On compressed-gas tank	
		Remove/install pressure reducing valve on compressed-gas tank (4)	AR86.60-D-0140A
8	Install in the reverse order		
9	Perform leakage test for gas system		AR86.60-D-0100A

MODEL 903.662

with CODE (ZU8) National version for USA

with CODE (Z29) "James Cook" touring camper, NAFTA

1 Compressed-gas tank cover

2 Nuts

3 Bolts

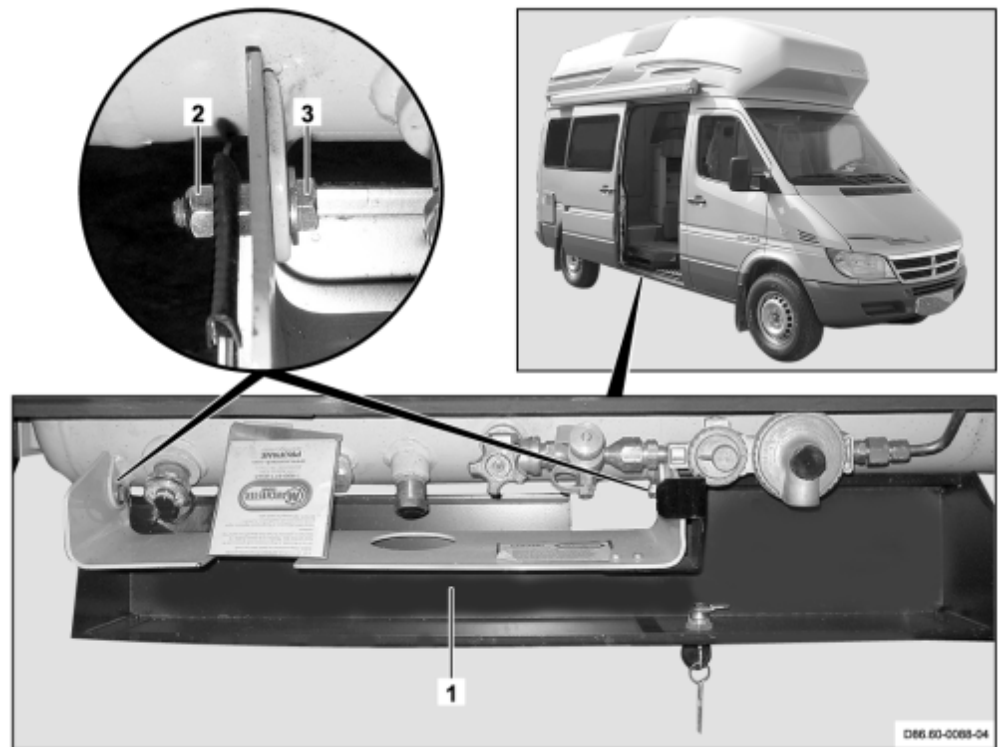

D86.60-0089-06

☒ ☒	Remove/Install		
⚠ Danger!	Risk of explosion caused by ignition of gas exiting the lines of the vehicle's gas system. Risk of injury caused by burns to skin and eyes.	Before commencing any work, ensure that all sources of ignition have been removed and that the gas system is completely emptied if necessary. Wear protective clothing.	AS86.00-Z-0004-01A
ⓘ	Notes on self-locking nuts and bolts	All models	AH00.00-N-0001-01A
1	Open compressed-gas tank covering (1)		
2	Unscrew nuts (2)	i Installation: Replace self-locking nuts (2).	
3	Unscrew screws (3)		
4	Remove compressed-gas tank cover (1)		

MODEL 903.662

with CODE (ZU8) National version for USA

with CODE (Z29) "James Cook" touring camper, NAFTA

1 Compressed-gas tank cover

2 Fill level indicator

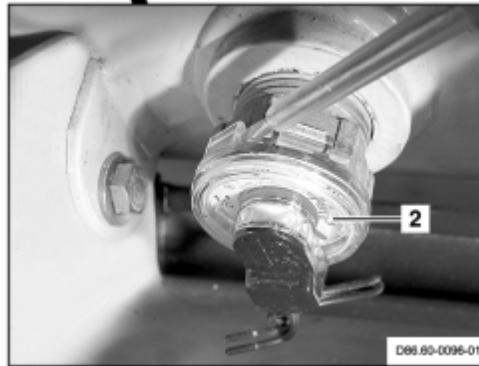
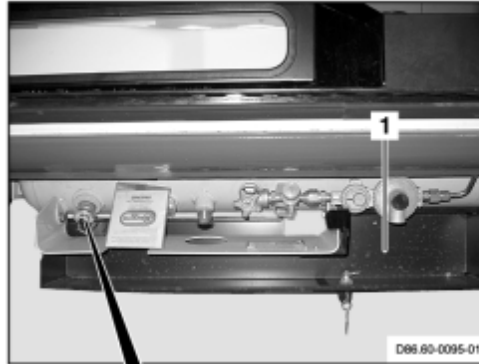

D86.60-0097-06

⚠ Danger!	Risk of explosion caused by ignition of gas exiting the lines of the vehicle's gas system. Risk of injury caused by burns to skin and eyes.	Before commencing any work, ensure that all sources of ignition have been removed and that the gas system is completely emptied if necessary. Wear protective clothing.	AS86.00-Z-0004-01A
1	Open compressed-gas tank cover (1)		
2	Unlock fill level indicator (2) on compressed-gas tank and pull off	Do not overstretch lugs on fill level indicator (2) when releasing. Risk of cracks and fracture!	
3	Install in the reverse order		

MODEL 903.662

with CODE (ZU8) National version for USA

with CODE (Z29) "James Cook" touring camper, NAFTA

On compressed-gas tank

- 1 Main shut-off valve
- 2 Gas line
- 3 Reducer
- 4 Removal connection piece
- 5 Pressure reducing valve

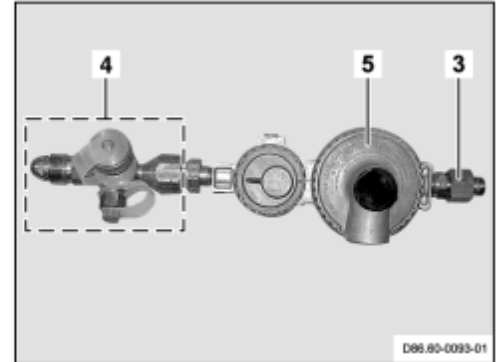
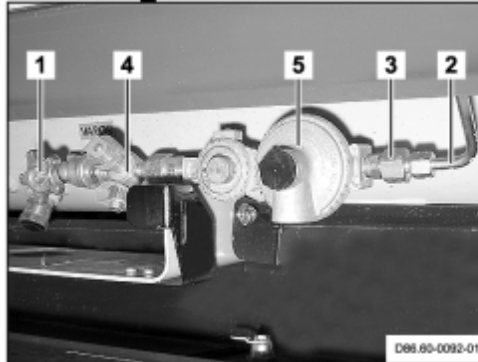

D86.60-0094-06

☒ ☒	Remove/install		
⚠ Danger!	Risk of explosion caused by ignition of gas exiting the lines of the vehicle's gas system. Risk of injury caused by burns to skin and eyes.	Before commencing any work, ensure that all sources of ignition have been removed and that the gas system is completely emptied if necessary. Wear protective clothing.	AS86.00-Z-0004-01A
1	Close main shut-off valve (1) on compressed-gas tank	i See Operator's Manual	
2	Disconnect gas line (2) from reducer (3)		
3	Unscrew removal connection piece (4) with pressure reducing valve (5) from main shut-off valve (1)	i Left-hand thread.	
4	Unscrew removal connection	i Left-hand thread.	

	piece (4) from pressure reducing valve (5)		
		i Observe installation position of removal connection piece (4) to pressure reducing valve (5)	
5	Unscrew reducer (3) from pressure reducing valve (5)		
6	Install in the reverse order		
7	Perform leakage test for gas system		AR86.60-D-0100A

MODEL 903.662

with CODE (ZU8) National version for USA

with CODE (Z29) "James Cook" touring camper, NAFTA

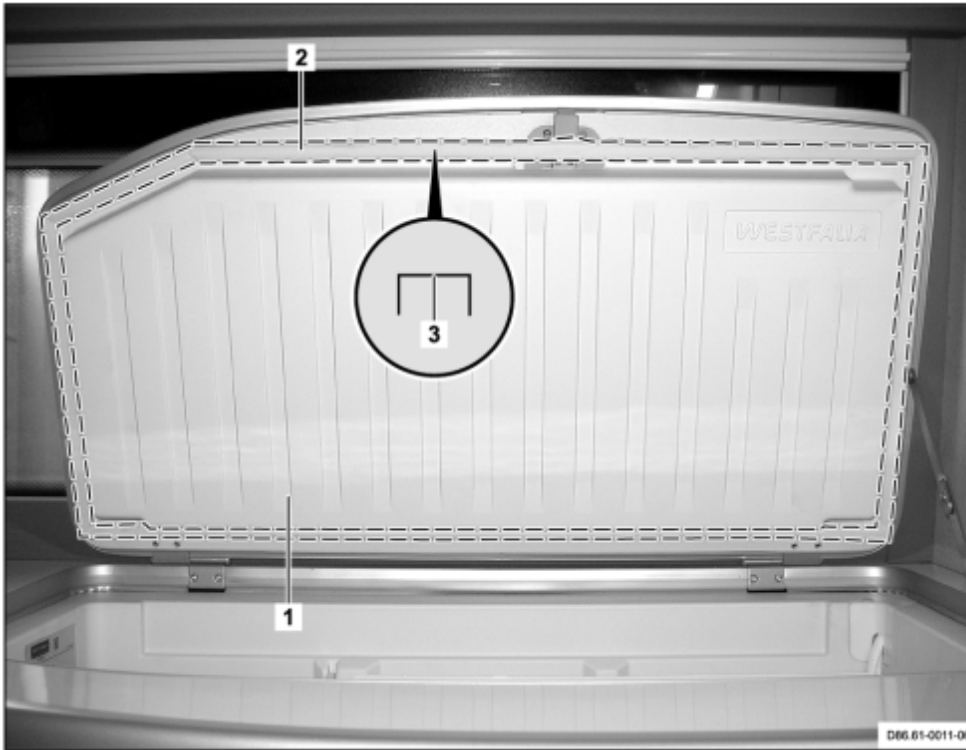

D86.61-0012-09

1 Insulating part

2 Cover gasket

3 Clamps

☒ ☒	Remove/Install		
⚠ Danger!	Risk of injury caused by body parts becoming jammed, pinched or severed by doors, covers, flaps or by loose components	Keep body parts well clear when moving doors, covers, flaps and components. Wear protective gloves and protective shoes.	AS00.00-Z-0025-01A
1	Switch off refrigerator box	i See Operator's Manual	
2	Open refrigerator box cover		
3	Remove clips (3)	i Below entire cover gasket (2) in marked area	
4	Remove insulating part (1) with cover gasket (2)		
5	Install in the reverse order		

MODEL 903.662

with CODE (ZU8) National version for USA

with CODE (Z29) "James Cook" touring camper, NAFTA

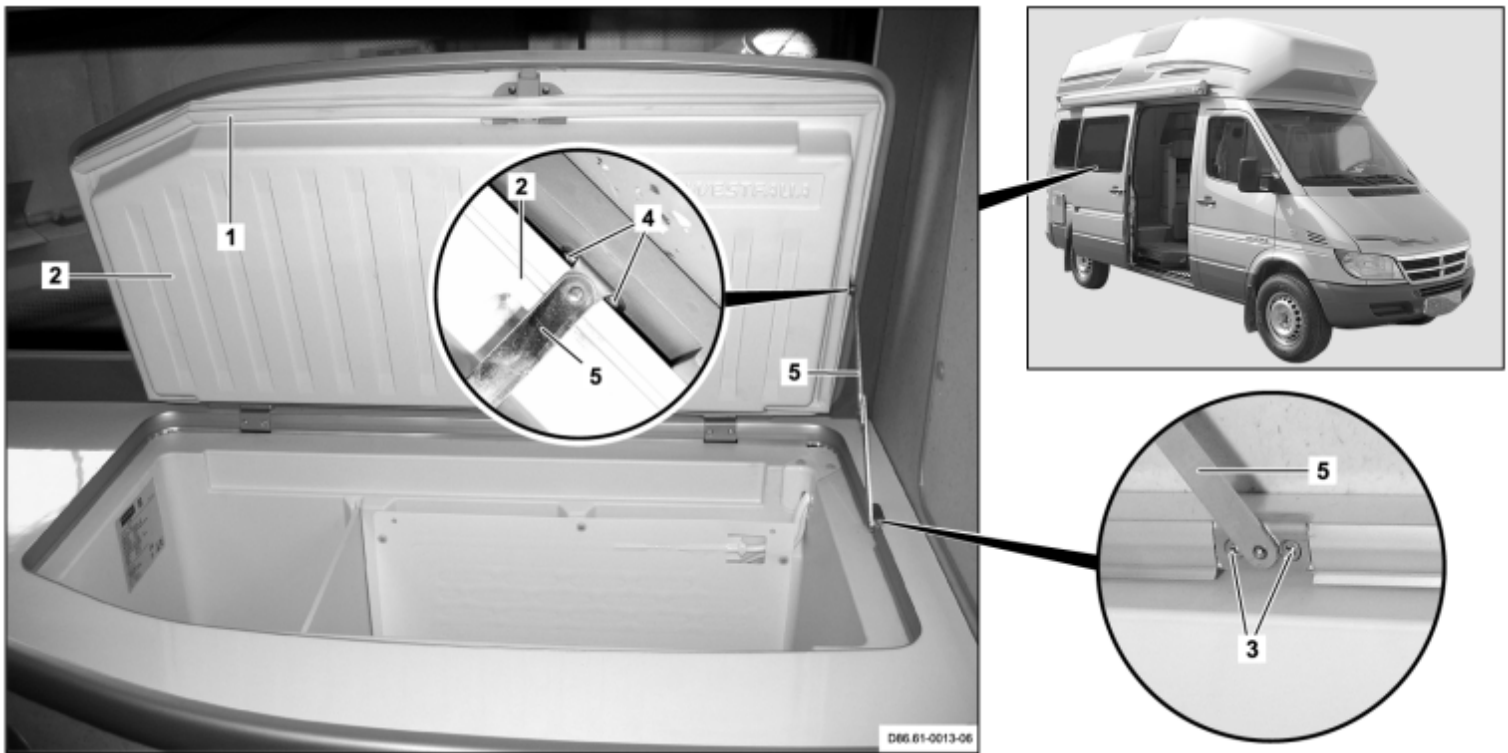

D86.61-0014-09

1 Cover gasket
2 Insulating part

3 Bolts
4 Bolts

5 Arrester

☒ ☒	Remove/Install		
⚠ Danger!	Risk of injury caused by body parts becoming jammed, pinched or severed by doors, covers, flaps or by loose components	Keep body parts well clear when moving doors, covers, flaps and components. Wear protective gloves and protective shoes.	AS00.00-Z-0025-01A
1	Switch off refrigerator box	i See Operator's Manual	
2	Open refrigerator box cover		
3	Remove cover gasket (1) with insulating part (2) for refrigerator box		AR86.61-D-0052A
4	Remove bolts (3)		
5	Remove bolts (4).		
6	Remove arrester (5)		

MODEL 903.662

with CODE (ZU8) National version for USA

with CODE (Z29) "James Cook" touring camper, NAFTA

1 Insulating part

2 Bolts

3 Bottom section of cover lock

4 Top section of cover lock

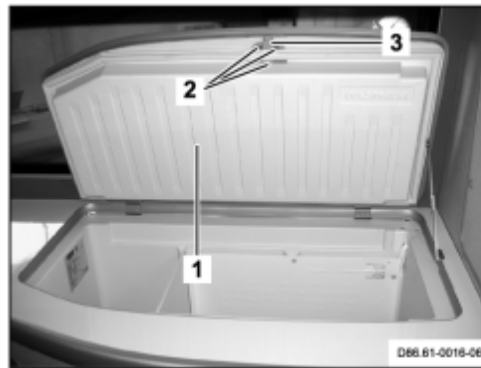
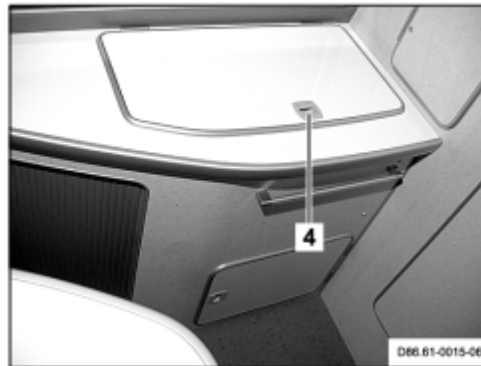

D86.61-0017-06

☒ ☒	Remove/Install		
⚠ Danger!	Risk of injury caused by body parts becoming jammed, pinched or severed by doors, covers, flaps or by loose components	Keep body parts well clear when moving doors, covers, flaps and components. Wear protective gloves and protective shoes.	AS00.00-Z-0025-01A
1	Switch off refrigerator box	i See Operator's Manual	
2	Remove insulating part (1) with cover gasket for refrigerator box		AR86.61-D-0052A
3	Unscrew bolts (2)		
4	Remove cover lock bottom section (3)		
5	Remove cover lock top section (4)		
6	Install in the reverse order		

MODEL 903.662

with CODE (ZU8) National version for USA

with CODE (Z29) "James Cook" touring camper, NAFTA

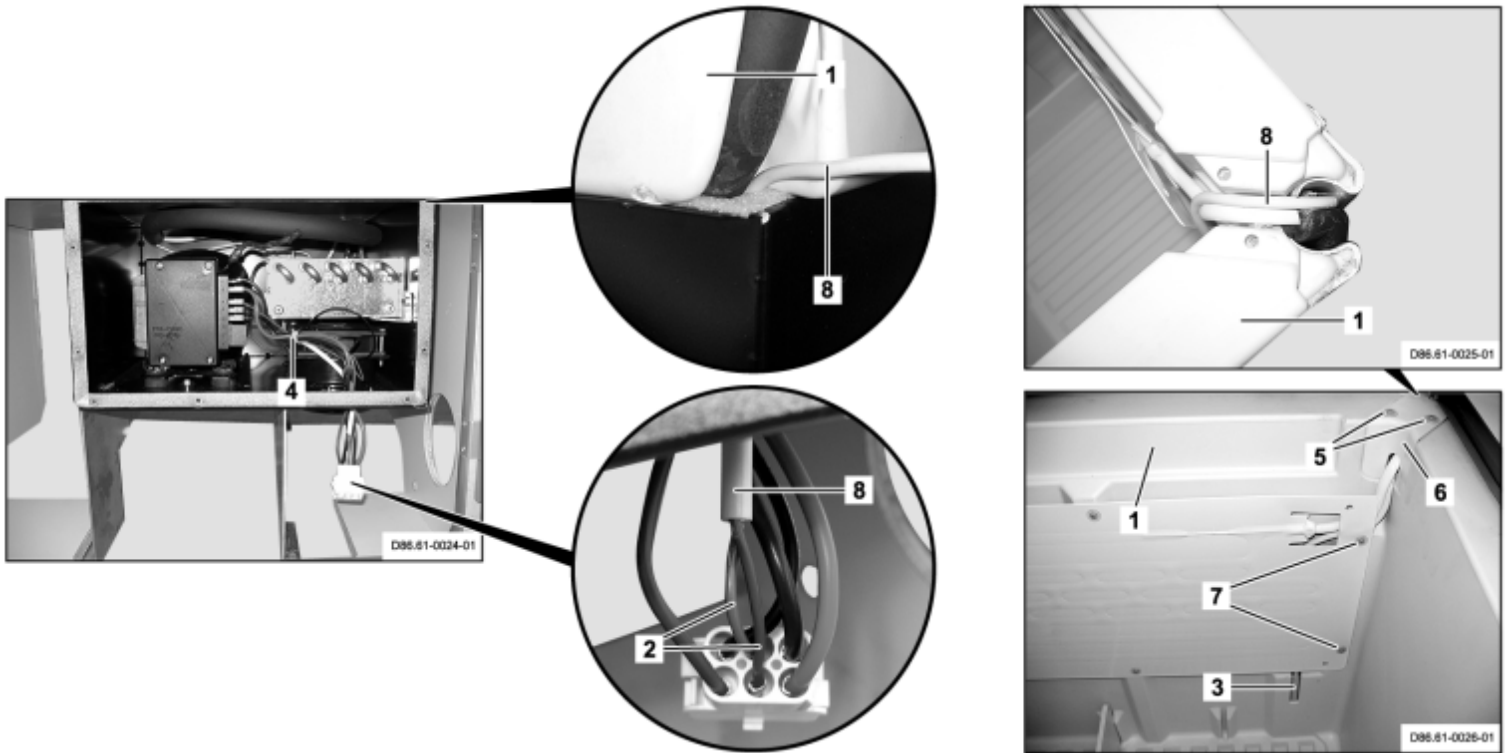

1 Refrigerator box
2 Electrical line
3 Temperature sensor

4 Tie strap
5 Clips
6 Cover

7 Clips
8 Electrical line

☒ ☒	Remove/Install		
⚠ Danger!	Risk of injury caused by exiting refrigerant and by contact with the components of the refrigerant system	Wear protective clothing, safety gloves and safety glasses	AS86.61-Z-0002-01A
1	Remove stowage cabinet	Refrigerator box	AR86.60-D-0045A
2	Remove refrigerator box (1)		AR86.61-D-1010A
3	Unpin electrical line (2) for temperature sensor (3) from electrical connector	i Mark installation position of electrical line (2).	
4	Remove tie strap (4)		

5	Remove clips (5)		
6	Remove cover (6)		
7	Remove clips (7)		
8	Unclip temperature sensor (2)		
9	Remove electrical line (8) from refrigerator box (1)	i Observe installation position of electrical line (8)	
10	Remove temperature sensor (3)		
11	Install in the reverse order		
12	Perform a function test	i Switch on refrigerator box (1) and check temperature with aid of central electronic system (see operating instructions).	

MODEL 903.662

with CODE (ZU8) National version for USA

with CODE (Z29) "James Cook" touring camper, NAFTA



D86.61-0010-09

1 Refrigerator box cover

2 Bolts

3 Bolts

☒ ☒	Remove/Install		
⚠ Danger!	Risk of injury caused by body parts becoming jammed, pinched or severed by doors, covers, flaps or by loose components	Keep body parts well clear when moving doors, covers, flaps and components. Wear protective gloves and protective shoes.	AS00.00-Z-0025-01A
1	Switch off refrigerator box	[i] See Operator's Manual	
2	Open refrigerator box cover (1)		
3	Unscrew bolts (2)		
4	Remove bolts (3)		
5	Remove refrigerator box cover (1)	[i] When refrigerator box cover (1) transfer the following components. See ↓	
		Remove/install cover gasket for refrigerator box	AR86.61-D-0052A

		Remove/install arrester for kitchen element refrigerator box cover	AR86.61-D-0053A
		Remove/install refrigerator box cover lock	AR86.61-D-0054A
6	Install in the reverse order		

MODEL 903.662

with CODE (ZU8) National version for USA

with CODE (Z29) "James Cook" touring camper, NAFTA

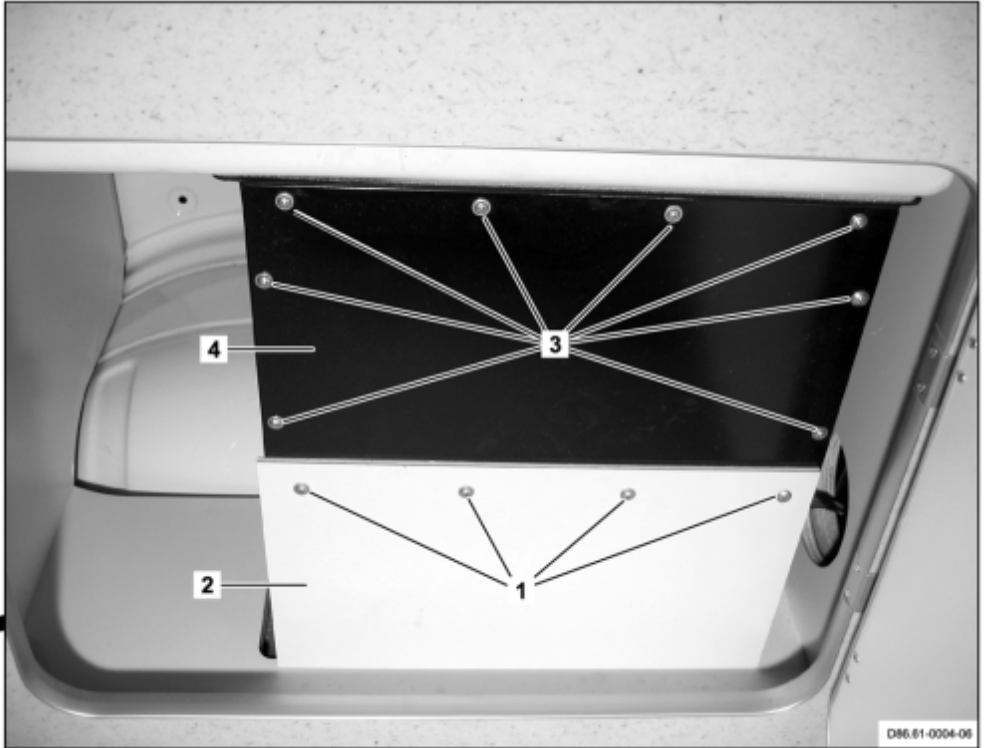

D86.61-0005-09

1 Bolts
2 Covering

3 Bolts

4 Cover panel

	Remove/Install		
1	Open assembly flap of stowage compartment at bottom		
2	Remove screws (1)		
3	Remove cover (2)		
4	Remove screws (3)		
5	Remove cover (4)		
6	Install in the reverse order		

MODEL 903.662

with CODE (ZU8) National version for USA

with CODE (Z29) "James Cook" touring camper, NAFTA

- 1 Bolts
- 2 Cover panel
- 3 Bolts
- 4 Refrigerator box



D86.61-0023-05

☒ ☒	Remove/Install		
⚠ Danger!	Risk of injury caused by scraping or cutting body parts on sharp vehicle parts	Always wear protective gloves when working on or near sharp and non-deburred vehicle parts. Deburr repair panels.	AS00.00-Z-0017-01B
⚠ Danger!	Risk of injury caused by body parts becoming jammed, pinched or severed by doors, covers, flaps or by loose components	Keep body parts well clear when moving doors, covers, flaps and components. Wear protective gloves and protective shoes.	AS00.00-Z-0025-01A
⚠ Danger!	Risk of injury caused by exiting refrigerant and by contact with the components of the refrigerant system	Wear protective clothing, safety gloves and safety glasses	AS86.61-Z-0002-01A
1	Switch off refrigerator box (4)	📘 See Operator's Manual	
2	Remove moldings from C-pillar	Right side	AR68.30-D-4490A
3	Remove stowage cabinet	Refrigerator box	AR86.60-D-0045A
4	Remove bolt caps (1)		
5	Remove bolts (1)		

6	Remove cover plate (2)		
7	Remove bolts (3)		
8	Open refrigerator box cover (4)		
9	Remove refrigerator box (4) from stowage cabinet toward rear		
10	Install in the reverse order		
11	Perform a function test	i Switch on refrigerator box (4) (see operating instructions).	

MODEL 903.662

with CODE (ZU8) National version for USA

with CODE (Z29) "James Cook" touring camper, NAFTA

- 1 Tachometer
2 Control unit
3 Electrical line

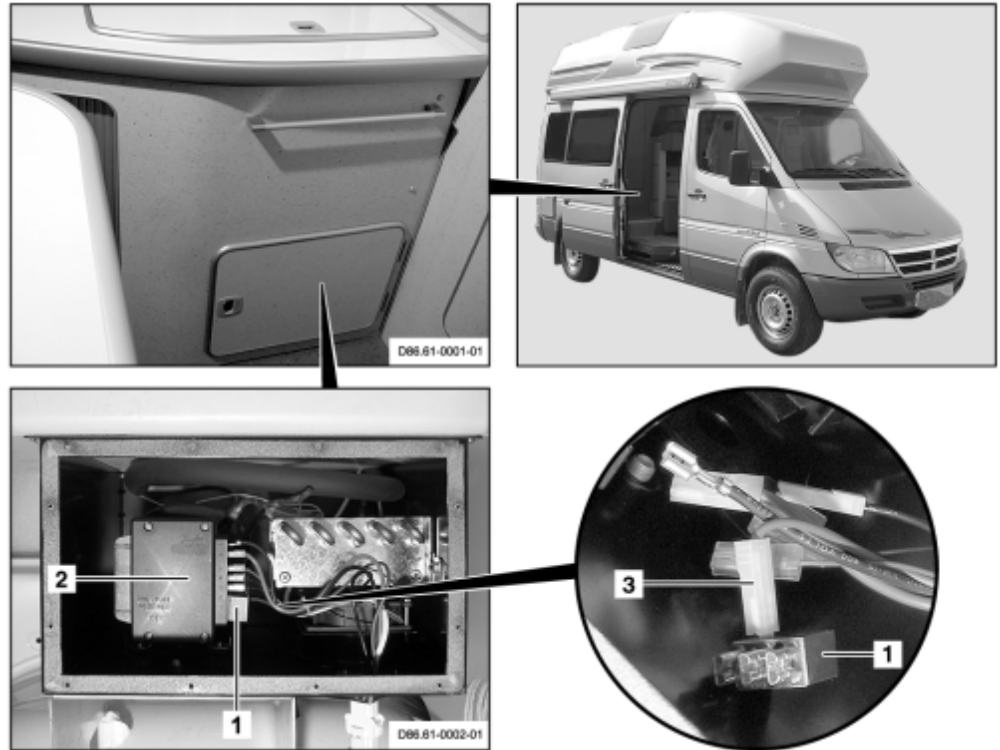

D86.61-0003-06

☒ ☒	Remove/Install		
⚠ Danger!	Risk of injury caused by body parts becoming jammed, pinched or severed by doors, covers, flaps or by loose components	Keep body parts well clear when moving doors, covers, flaps and components. Wear protective gloves and protective shoes.	AS00.00-Z-0025-01A
⚠ Danger!	Risk of injury caused by exiting refrigerant and by contact with the components of the refrigerant system	Wear protective clothing, safety gloves and safety glasses	AS86.61-Z-0002-01A
1	Switch off refrigerator box	ⓘ See Operator's Manual	
2	Remove refrigerator box cover		AR86.61-D-1003A
3	Remove tachometer (1) from control unit (2) of refrigerator box		
4	Disconnect electrical lines (3) from tachometer (1)		

5	Install in the reverse order		
6	Perform a function test	i Switch on refrigerator box (see operating instructions)	

MODEL 903.662

with CODE (ZU8) National version for USA

with CODE (Z29) "James Cook" touring camper, NAFTA

- 1 Tachometer
- 2 Electrical lines
- 3 Control unit
- 4 Screw

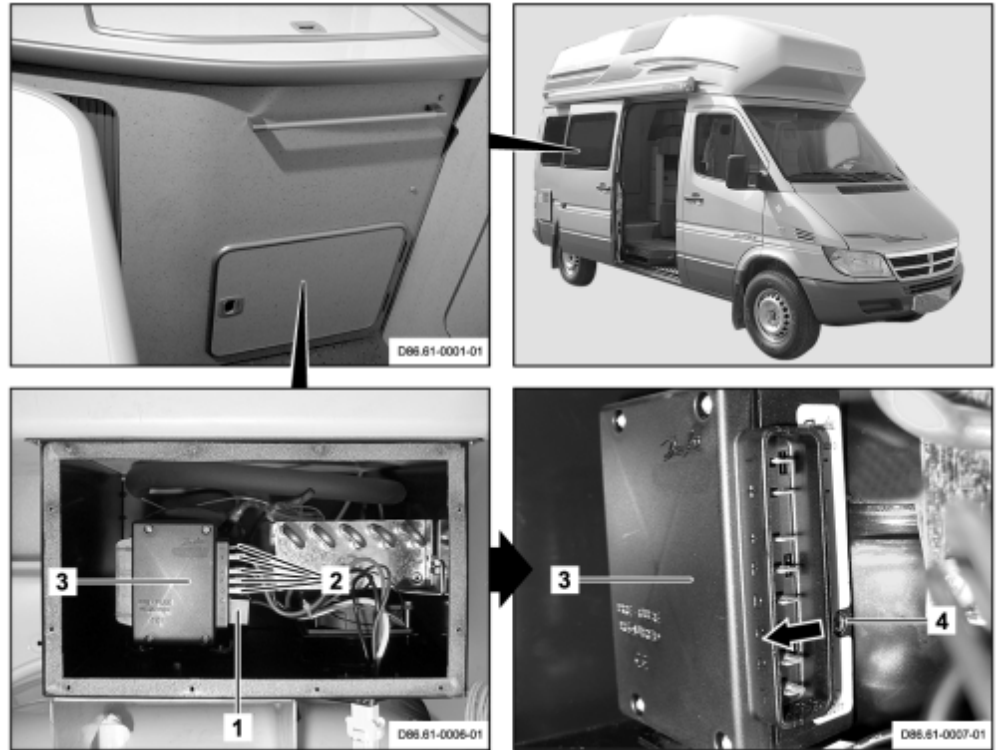

D86.61-0008-06

☒ ☒	Remove/Install		
⚠ Danger!	Risk of injury caused by scraping or cutting body parts on sharp vehicle parts	Always wear protective gloves when working on or near sharp and non-deburred vehicle parts. Deburr repair panels.	AS00.00-Z-0017-01B
⚠ Danger!	Risk of injury caused by exiting refrigerant and by contact with the components of the refrigerant system	Wear protective clothing, safety gloves and safety glasses	AS86.61-Z-0002-01A
1	Switch off refrigerator box	i See Operator's Manual	
2	Remove refrigerator box cover		AR86.61-D-1003A
3	Remove tachometer (1) from control unit (3) of refrigerator box		
4	Mark installation position of all electrical lines (2)		

5	Remove all electrical lines (2) from control unit (3) of refrigerator box		
6	Completely screw in bolt (4)	i Bolt (4) serves for locking control unit (3) on refrigerator box.	
		i Installation: Unscrew bolt (4) only until control unit (3) of refrigerator box is locked again.	
7	Remove control unit (3) from refrigerator box	i By pulling control unit (3) toward front on right side (arrow).	
8	Install in the reverse order		
9	Perform a function test	i Switch on refrigerator box (see operating instructions).	

MODEL 903.662

with CODE (ZU8) National version for USA

with CODE (Z29) "James Cook" touring camper, NAFTA

1 Control unit

2 Tie strap

3 Bolts

4 Fan

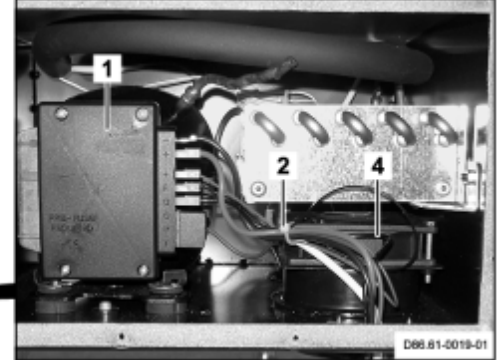
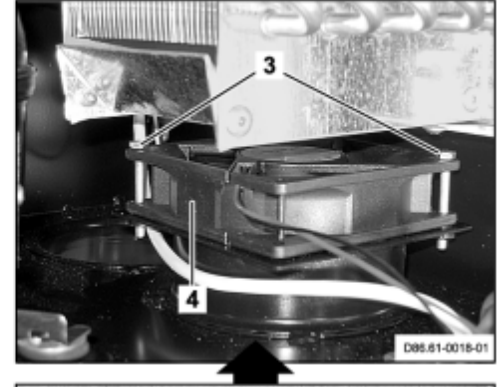

D86.61-0020-06

☒ ☒	Remove/Install		
⚠ Danger!	Risk of injury caused by scraping or cutting body parts on sharp vehicle parts	Always wear protective gloves when working on or near sharp and non-deburred vehicle parts. Deburr repair panels.	AS00.00-Z-0017-01B
⚠ Danger!	Risk of injury caused by exiting refrigerant and by contact with the components of the refrigerant system	Wear protective clothing, safety gloves and safety glasses	AS86.61-Z-0002-01A
1	Switch off refrigerator box	i See Operator's Manual	
2	Remove refrigerator box cover		AR86.61-D-1003A
3	Remove control unit (1) from refrigerator box		AR86.61-D-1050A
4	Remove tie straps (2).		
5	Remove bolts (3)		

6	Remove fan (4) from refrigerator box		
7	Install in the reverse order		
8	Perform a function test	i Switch on refrigerator box (see operating instructions)	

MODEL 903.662

with CODE (ZU8) National version for USA

with CODE (Z29) "James Cook" touring camper, NAFTA

Left side wall

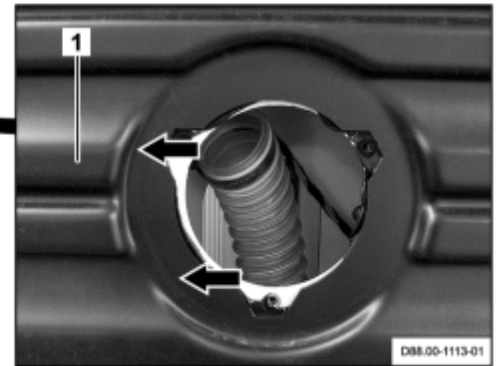

D88.00-1114-08

1 Covering

1 Covering

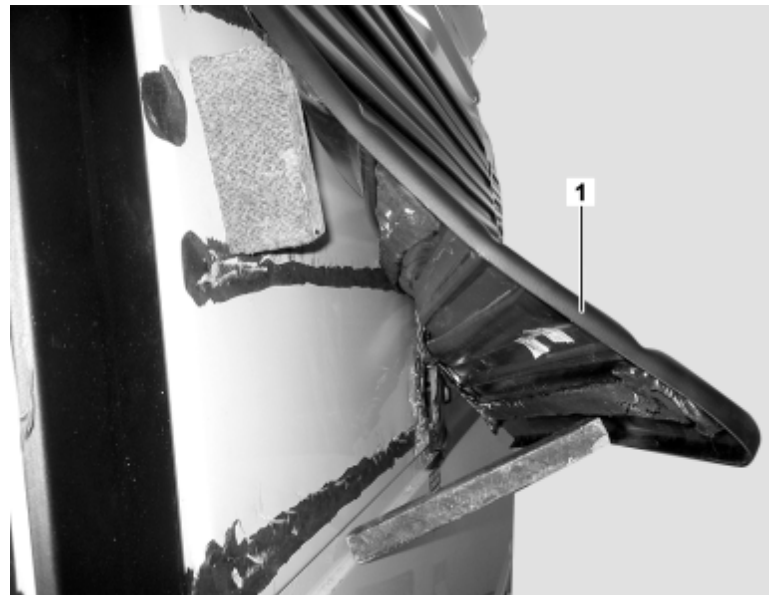

D88.00-1115-11

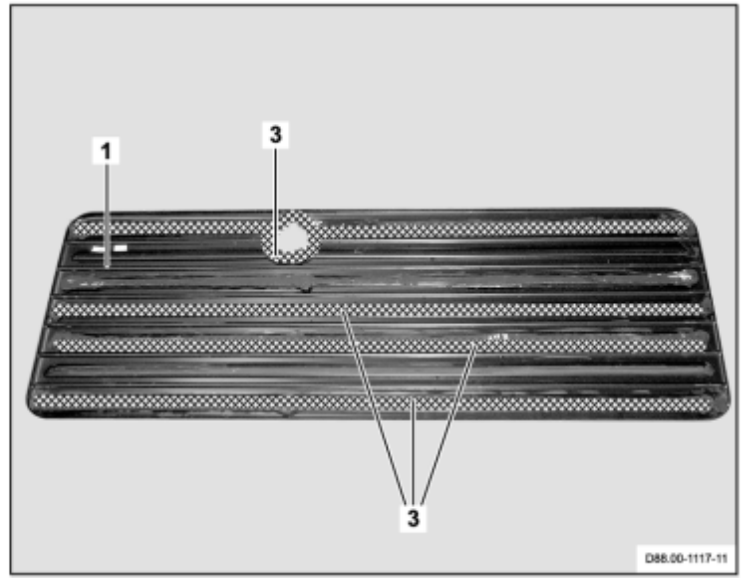
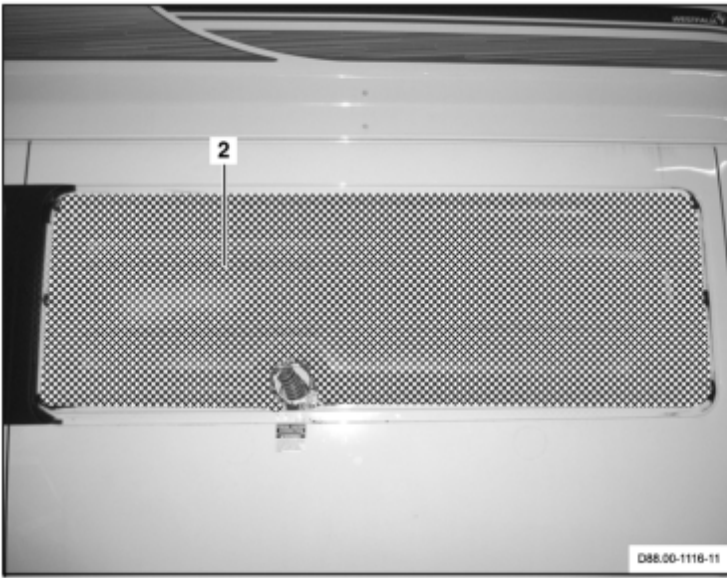

D88.00-1118-08

1 Covering





2 Adhesive surface

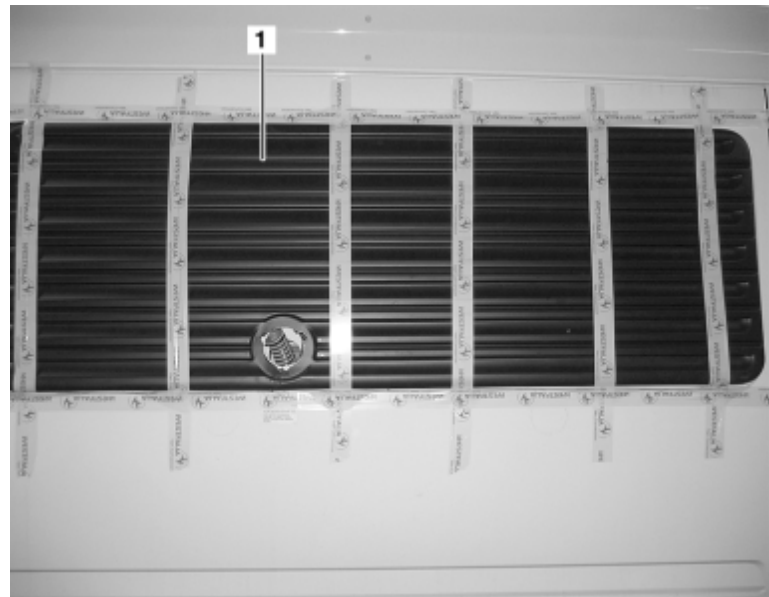





3 Adhesive surface

1 Covering



D88.00-1119-11

	Remove		
 Danger!	Risk of injury caused by scraping or cutting body parts on sharp vehicle parts	Always wear protective gloves when working on or near sharp and non-deburred vehicle parts. Deburr repair panels.	AS00.00-Z-0017-01B
1	Remove fresh water filler fittings		AR86.30-D-0063A
2	Loosen covering (1) with suitable tool	 Start loosening covering (1) at marked points (arrows)	
		 Covering (1) cannot be removed without damage. When	

		loosening hold covering (1) under tension	
3	Remove cover (1)		
	Install		
4	Clean gluing surface (2)	 Allow to air-dry according to manufacturer's specifications	
		Adhesion cleaner	BR00.45-Z-1014-04A
5	Roughen gluing surface (3) on covering (1)		
6	Clean gluing surface (3)	 Allow to air-dry according to manufacturer's specifications	
		Adhesion cleaner	BR00.45-Z-1014-04A
7	Apply primer to gluing surface (3)	 Use suitable primer	
		 Allow to air-dry according to manufacturer's specifications	
8	Apply glue to gluing surface (3)	Sikaflex 252 adhesive compound for glued paneling	BR00.45-Z-1021-02A
9	Position covering (1) on gluing surface (3)	 Firmly press on covering (1)	
10	Fasten covering (1) with adhesive tape.		
11	Install fresh water filler necks		AR86.30-D-0063A

Auxiliary repair materials

Number	Designation	Order number
BR00.45-Z-1021-02A	Sikaflex 252 adhesive compound for glued paneling	005 989 36 71
BR00.45-Z-1014-04A	Adhesion cleaner	003 989 72 71

MODEL 903.662

with CODE (ZU8) National version for USA

with CODE (Z29) "James Cook" touring camper, NAFTA

Rear door window cover

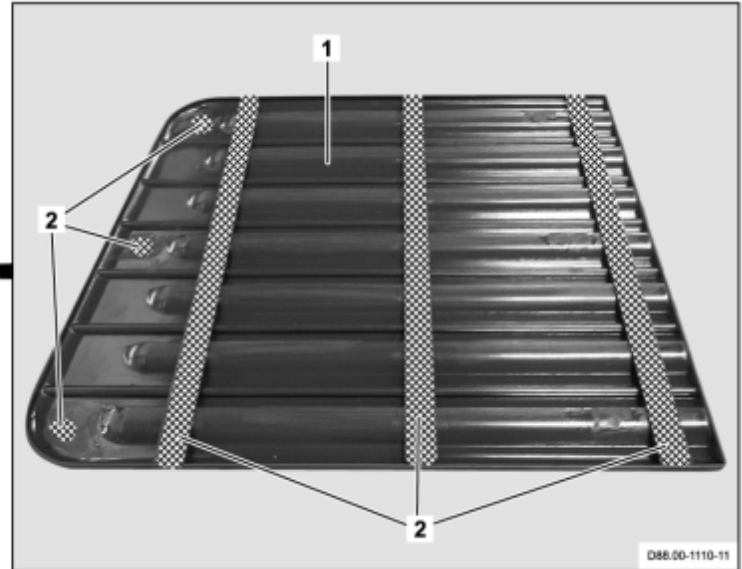

D88.00-1111-08

1 Covering

2 Gluing surfaces

	Remove		
Danger!	Risk of injury caused by scraping or cutting body parts on sharp vehicle parts	Always wear protective gloves when working on or near sharp and non-deburred vehicle parts. Deburr repair panels.	AS00.00-Z-0017-01B
1	Loosen covering (1) with suitable tool	Covering (1) cannot be removed without damage. When loosening hold covering (1) under tension	
2	Remove cover (1)		
	Install		
3	Clean gluing surface on vehicle	Allow to air-dry according to manufacturer's specifications	
		Adhesion cleaner	BR00.45-Z-1014-04A
4	Roughen gluing surface (2) on covering (1)		

5	Clean gluing surfaces (2)	i Allow to air-dry according to manufacturer's specifications	
		Adhesion cleaner	BR00.45-Z-1014-04A
6	Apply primer to gluing surfaces (2)	i Use suitable primer	
		i Allow to air-dry according to manufacturer's specifications	
7	Apply glue to gluing surfaces (2)	Sikaflex 252 adhesive compound for glued paneling	BR00.45-Z-1021-02A
8	Position covering (1) on gluing surface on vehicle	i Align covering (1) and press on firmly.	
9	Fasten covering (1) with adhesive tape.		

Auxiliary repair materials

Number	Designation	Order number
BR00.45-Z-1021-02A	Sikaflex 252 adhesive compound for glued paneling	005 989 36 71
BR00.45-Z-1014-04A	Adhesion cleaner	003 989 72 71

MODEL 903.662

with CODE (ZU8) National version for USA

with CODE (Z29) "James Cook" touring camper, NAFTA

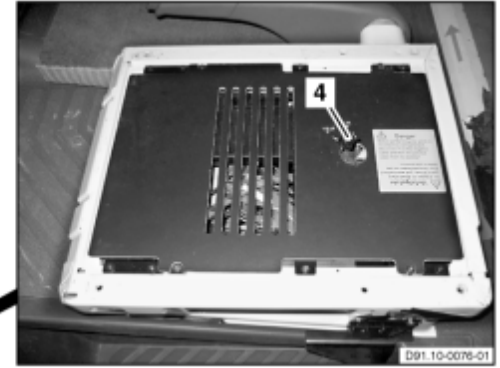
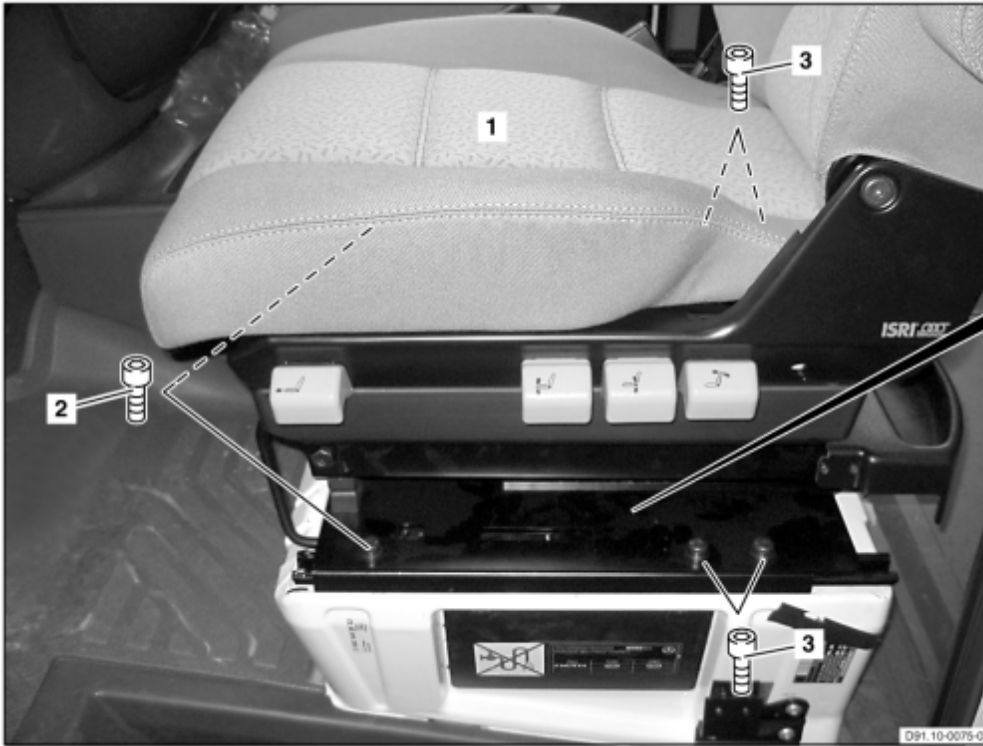

D91.10-0074-09

1 Driver seat
2 Bolts

3 Bolts

4 Electrical connector

☒ ☒	Remove/Install		
⚠ Danger!	Risk of injury caused by scraping or cutting body parts on sharp vehicle parts	Always wear protective gloves when working on or near sharp and non-deburred vehicle parts. Deburr repair panels.	AS00.00-Z-0017-01B
1	Slide driver seat (1) backwards	[i] See Operator's Manual	
2	Unscrew bolts (2)		
3	Slide driver seat (1) forwards	[i] See Operator's Manual	
4	Remove bolts (3)		
5	Tilt driver seat (1) to the side		
6	Disconnect electrical connector (4)		

7	Remove driver seat (1)		
8	Install in the reverse order		

MODEL 903.662

with CODE (ZU8) National version for USA

with CODE (Z29) "James Cook" touring camper, NAFTA

- 1 Bolts
- 2 Rotating base
- 3 Passenger seat
- 4 Electrical connector

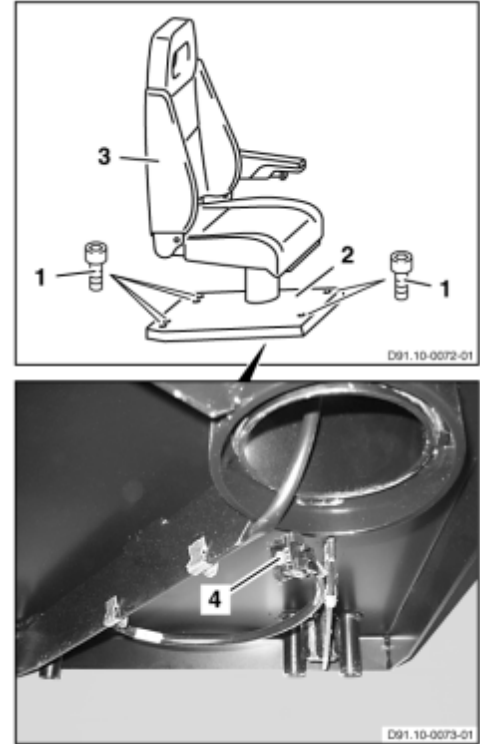

D91.10-0071-03

☒ ☒	Remove/Install		
⚠ Danger!	Risk of injury caused by scraping or cutting body parts on sharp vehicle parts	Always wear protective gloves when working on or near sharp and non-deburred vehicle parts. Deburr repair panels.	AS00.00-Z-0017-01B
1	Remove caps from screws (1)		
2	Unscrew bolts (1) at rotating base (2)		
3	Tilt rotating base (2) with front passenger seat (3) to the side		
4	Disconnect electrical connector (4)		
5	Remove rotating base (2) with front passenger seat (3)		
6	Release front passenger seat (3) and rotate		

7	Remove front passenger seat (3) from rotating base (2)		
8	Install in the reverse order		

MODEL 903.662

with CODE (ZU8) National version for USA

with CODE (Z29) "James Cook" touring camper, NAFTA
driver seat



1 Trim panel

2 Hand brake lever

3 Seat frame



D91.10-0056-11

 	Remove/Install		
1	Undo the velcro fastener at the trim (1) for the hand brake lever (2)		
2	Remove the trim panel (1) from the seat frame (3)	 Installation: Check for correct seating of trim panel (1).	
3	Install in the reverse order		

MODEL 903.662

with CODE (ZU8) National version for USA

with CODE (Z29) "James Cook" touring camper, NAFTA

1 Bolts
2 Cover

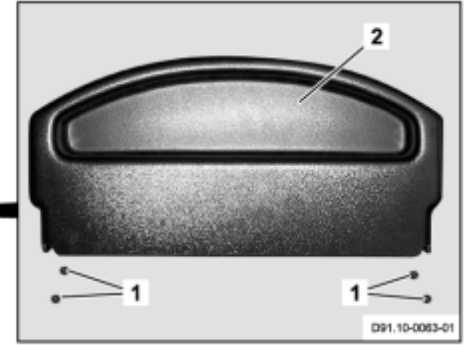

D91.10-0061-04

	Remove/Install		
1	Remove screws (1)		
2	Remove cover (2)		
3	Install in the reverse order		

MODEL 903.662

with CODE (ZU8) National version for USA

with CODE (Z29) "James Cook" touring camper, NAFTA

- 1 Bolts
- 2 Plate
- 3 Seat rails
- 4 Bolts
- 5 Turntable

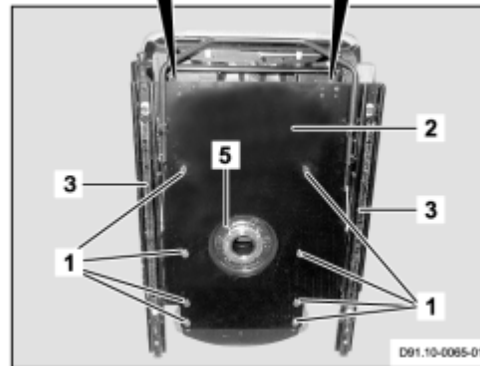
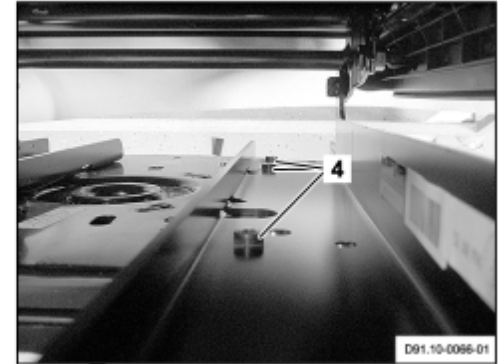
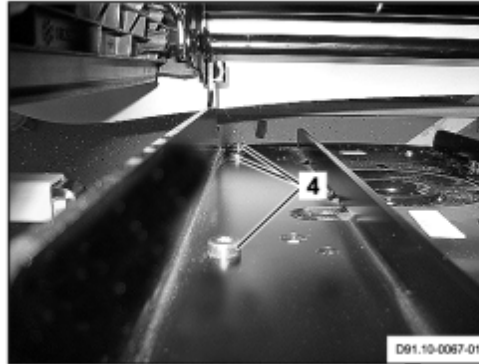

D91.10-0064-06

☒ ☒	Remove/Install		
⚠ Danger!	Risk of injury caused by scraping or cutting body parts on sharp vehicle parts	Always wear protective gloves when working on or near sharp and non-deburred vehicle parts. Deburr repair panels.	AS00.00-Z-0017-01B
1	Raise seat surface	i See Operator's Manual	
2	Remove driver's seat		AR91.10-D-1010B
3	Remove bolts (1)		
4	Remove plate (2) with seat rails (3)		
5	Remove bolts (4).		
6	Remove turntable (5)		
7	Install in the reverse order		

MODEL 903.662

with CODE (ZU8) National version for USA

with CODE (Z29) "James Cook" touring camper, NAFTA
front seats

1 Backrest

2 Electrical connector

3 Seat cushion

4 Lever

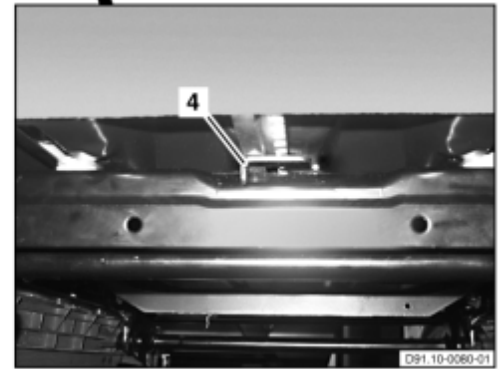

D91.10-0077-06

☒ ☒	Remove/Install		
1	Tip backrest (1) forward		
2	Separate electrical connector (2)		
3	Move the backrest (1) backwards		
4	Turn the front seat toward the outside		
5	Using lever (4), unlock the seat cushion (3) and pull it forward		
6	Remove seat cushion (3)		
7	Install in the reverse order		

MODEL 903.662

with CODE (ZU8) National version for USA

with CODE (Z29) "James Cook" touring camper, NAFTA

1 Backrest

2 Electrical connector

3 Bolts

4 Hose for lumbar support

5 Connecting piece

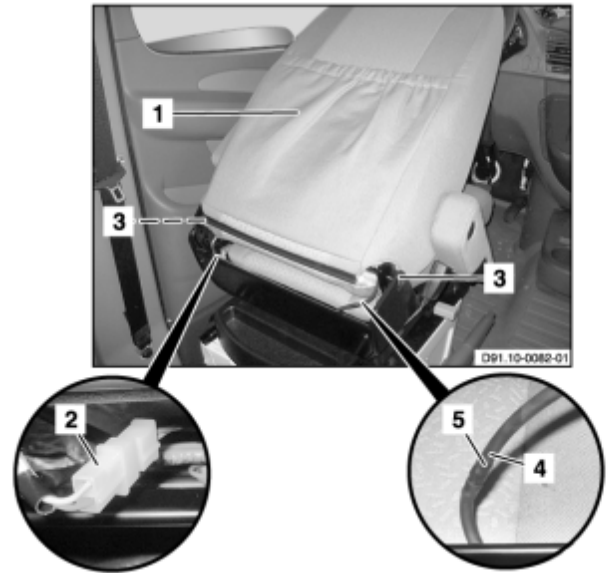

D91.10-0081-11

☒ ☒	Remove/Install		
⚠ Danger!	Risk of injury due to pinching, crushing or cutting off of limbs or other parts of the body by doors, covers, lids, flaps and other movable components	No limbs or other parts of the body should be within the operating range of the mechanism when moving components (doors, covers, lids, flaps, etc.). Wear protective gloves and work shoes.	AS00.00-Z-0025-01A
1	Drive front seat backwards		
2	Tip backrest (1) forward		
3	Separate electrical connector (2)		
4	Remove screws (3) from backrest (1)		
5	Detach hose for lumbar support (4) from connector (5)		
6	Remove backrest (1)		
7	Install in the reverse order		

MODEL 903.662

with CODE (ZU8) National version for USA

with CODE (Z29) "James Cook" touring camper, NAFTA

- 1 Cover
- 2 Armrest
- 3 Snap-in lug
- 4 Guide

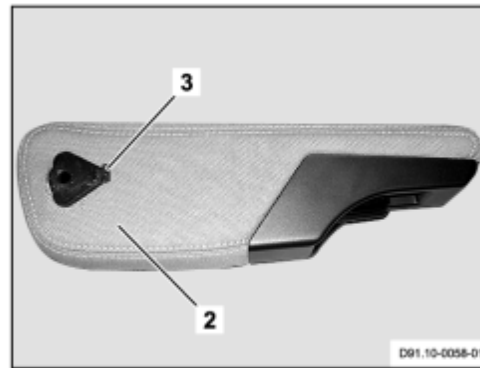
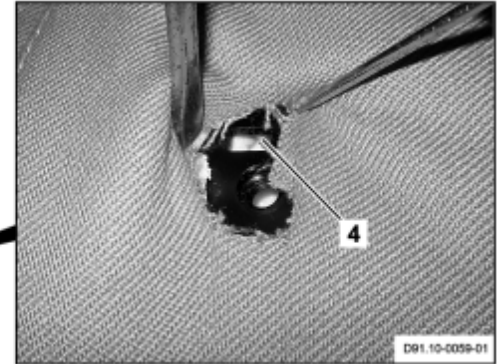
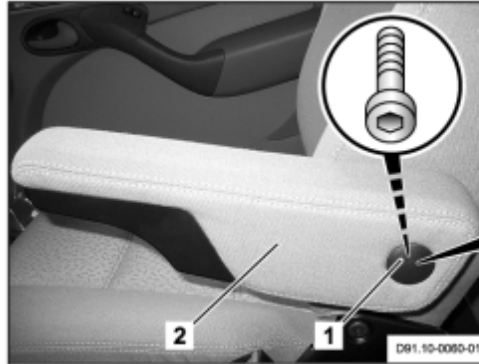

D91.10-0057-06

	Remove/Install		
1	Unclip covering (1)	Long wedge	115.589.03.59.00
2	Remove the screw under the cover (1)		
3	Remove armrest (2)	Installation: Make sure that the engagement lug (3) is properly positioned in the guide (4).	
4	Install in the reverse order		



115 589 03 59 00

Longitudinal wedge

MODEL 903.662

with CODE (ZU8) National version for USA

with CODE (Z29) "James Cook" touring camper, NAFTA

Driver seat

- 1 Bolts
- 2 Plate
- 3 Seat rails
- 4 Bolts

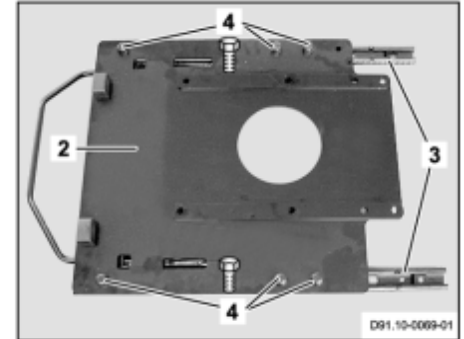
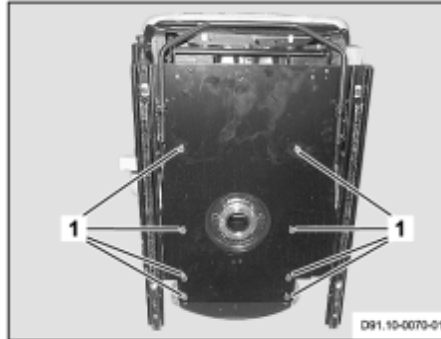

D91.10-0068-04

☒ ☒	Remove/Install		
⚠ Danger!	Risk of injury caused by scraping or cutting body parts on sharp vehicle parts	Always wear protective gloves when working on or near sharp and non-deburred vehicle parts. Deburr repair panels.	AS00.00-Z-0017-01B
1	Remove driver's seat		AR91.10-D-1010B
2	Remove bolts (1)		
3	Remove plate (2) with seat rails (3)		
4	Remove cover caps from screws (4)		
5	Remove bolts (4).		
6	Remove plate (2) from seat rails (3)		
7	Install in the reverse order		

MODEL 903.662

with CODE (ZU8) National version for USA

with CODE (Z29) "James Cook" touring camper, NAFTA

- 1 Screw
- 2 Stop
- 3 Bench seat
- 4 C-rail

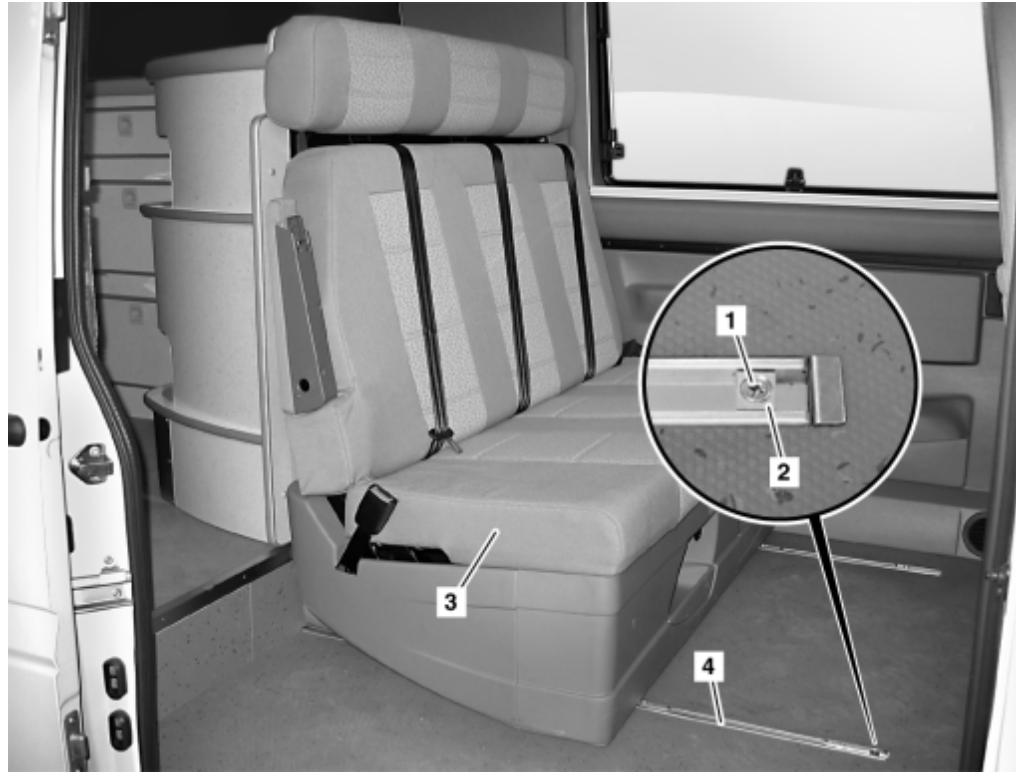

D91.12-1102-06

☒ ☒	Remove/Install		
⚠ Danger!	Risk of injury caused by body parts becoming jammed, pinched or severed by doors, covers, flaps or by loose components	Keep body parts well clear when moving doors, covers, flaps and components. Wear protective gloves and protective shoes.	AS00.00-Z-0025-01A
1	Remove screw (1)		
2	Remove stop (2) of bench seat (3)		
3	Slide bench seat (3) forwards	ⓘ See Operator's Manual	
4	Remove bench seat (3) out of C-rails (4)	ⓘ Helper required	
5	Install in the reverse order		

MODEL 903.662

with CODE (ZU8) National version for USA

with CODE (Z29) "James Cook" touring camper, NAFTA

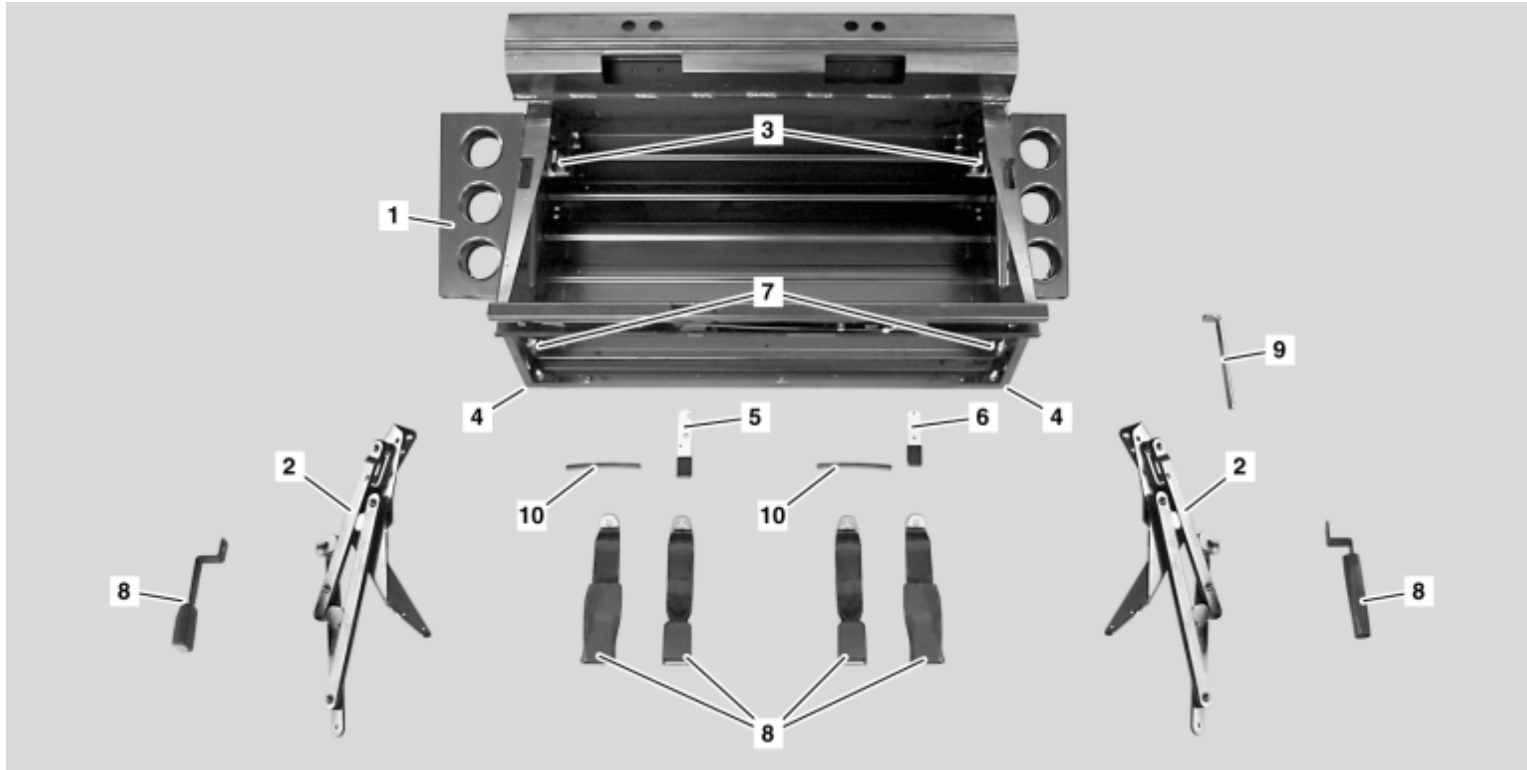

D91.12-1111-09

1 Bench seat casing
2 Backrest fittings
3 Sliding blocks
4 Sliding blocks

5 Notch lever
6 Adjustment lever
7 Index bolt

8 Seat belt buckles
9 Support
10 Edge guard

☒ ☒	Remove/Install		
⚠ Danger!	Risk of injury caused by body parts becoming jammed, pinched or severed by doors, covers, flaps or by loose components	Keep body parts well clear when moving doors, covers, flaps and components. Wear protective gloves and protective shoes.	AS00.00-Z-0025-01A
1	Remove paneling from bench seat casing (1)		AR91.21-D-5745A
2	Remove right side paneling from bench seat casing (1)		AR91.21-D-5746A
3	Remove backrest fittings (2)		AR91.21-D-4030A
4	Remove sliding blocks (3)	Rear sliding block	AR91.21-D-

			4040B
5	Remove sliding blocks (4)	Front sliding block	AR91.21-D-4040A
6	Remove notch lever (5) for seat bolster		AR91.21-D-4506A
7	Remove adjustment lever (6) for bench seat		AR91.21-D-4050A
8	Remove bench seat adjustment Bowden cable	Right Bowden cable	AR91.21-D-4060A
9	Remove bench seat adjustment Bowden cable	Left Bowden cable	AR91.21-D-4060B
10	Remove index bolt (7) for bench seat adjustment		AR91.21-D-4100A
11	Remove seat belt buckles (8)		AR91.40-D-1517A
		 Screws for seat belt buckle on rear seat	BA91.40-N-1010-01A
12	Remove support (9)		AR91.21-D-4120A
13	Remove edge guard (10)		
14	Install in the reverse order		

 **Seat belts/emergency tensioning retractors**

Number	Designation	Model 903.662 with code ZU8, Z29	
BA91.40-N-1010-01A	Screws for seat belt buckle on rear seat		Nm 38

MODEL 903.662

with CODE (ZU8) National version for USA

with CODE (Z29) "James Cook" touring camper, NAFTA

- 1 Armrest
- 2 Back cushion
- 3 Screw



D91.12-1107-06

☒ ☒	Remove/Install		
1	Fold armrest (1) upward		
2	Press back cushion (2) to the side		
3	Remove bolt (3)		
4	Remove armrest (1)		
5	Install in the reverse order		

MODEL 903.662

with CODE (ZU8) National version for USA

with CODE (Z29) "James Cook" touring camper, NAFTA

1 Bolts

2 Backrest fittings

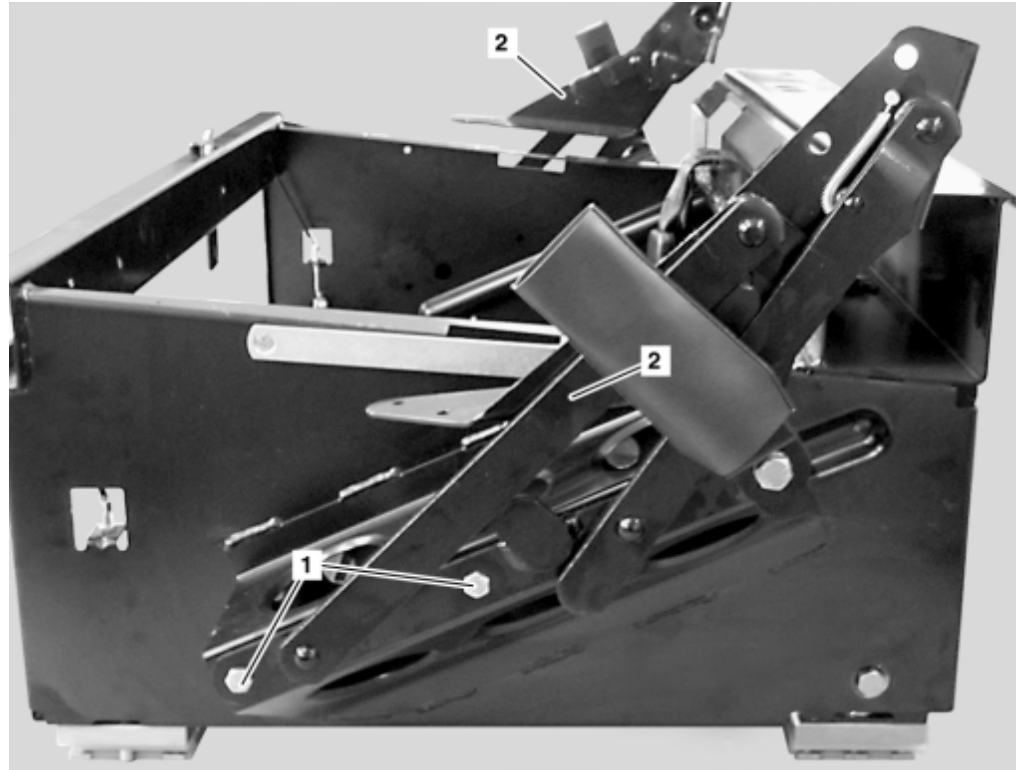

D91.12-1109-06

☒ ☒	Remove/Install		
⚠ Danger!	Risk of injury caused by body parts becoming jammed, pinched or severed by doors, covers, flaps or by loose components	Keep body parts well clear when moving doors, covers, flaps and components. Wear protective gloves and protective shoes.	AS00.00-Z-0025-01A
1	Remove bench seat backrest upholstery		AR91.21-D-4495A
2	Remove seat bolster for bench seat		AR91.21-D-4505A
3.1	Remove right side paneling from bench seat casing	ⓘ Only when removing right backrest fitting (2).	AR91.21-D-5746A
4	Remove seat belt buckle	ⓘ Only on the side on which the backrest fitting (2) is to be removed.	AR91.40-D-1517A
		ⓘ Screws for seat belt buckle on rear seat	BA91.40-N-1010-01A

5	Remove bolts (1)		
6	Remove backrest fittings (2)		
7	Install in the reverse order		

Nm **Seat belts/emergency tensioning retractors**

Number	Designation		Model 903.662 with code ZU8, Z29
BA91.40-N-1010-01A	Screws for seat belt buckle on rear seat	Nm	38

MODEL 903.662

with CODE (ZU8) National version for USA

with CODE (Z29) "James Cook" touring camper, NAFTA

Front sliding block

1 Bench seat

2 Seat cushion

3 Nuts

4 Sliding blocks

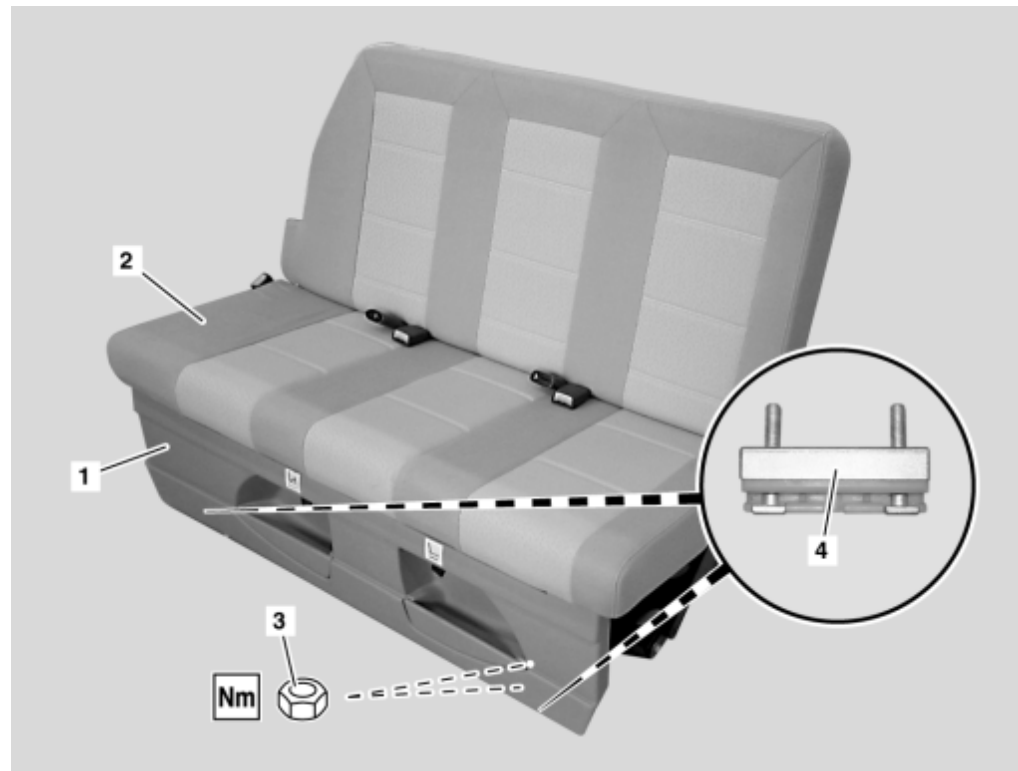

D91.12-1110-06

☒ ☒	Remove/Install		
⚠ Danger!	Risk of injury caused by body parts becoming jammed, pinched or severed by doors, covers, flaps or by loose components	Keep body parts well clear when moving doors, covers, flaps and components. Wear protective gloves and protective shoes.	AS00.00-Z-0025-01A
1	Remove bench seat (1)		AR91.21-D-4000A
2	Release seat bolster (2) and fold up	[i] See Operator's Manual	
3	Remove nuts (3)	[i] Installation: Only tighten nuts (3) when bench seat (1) is reinstalled and can be moved easily.	
		[Nm] Nut, sliding block to bench seat	BA91.12-N-1011-03A

4	Tilt bench seat (1) backwards		
5	Remove sliding block (4)		
6	Install in the reverse order		

Nm Rear seats

Number	Designation		Model 903.662 with code ZU8, Z29
BA91.12-N-1011-03A	Nut, sliding block to bench seat	Nm	20

MODEL 903.662

with CODE (ZU8) National version for USA

with CODE (Z29) "James Cook" touring camper, NAFTA

Rear sliding block

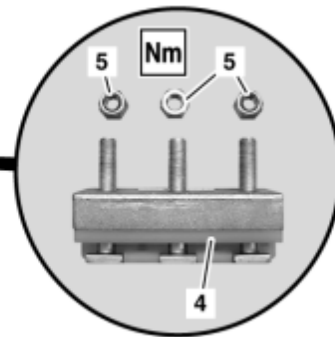
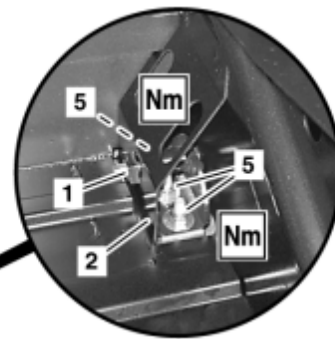
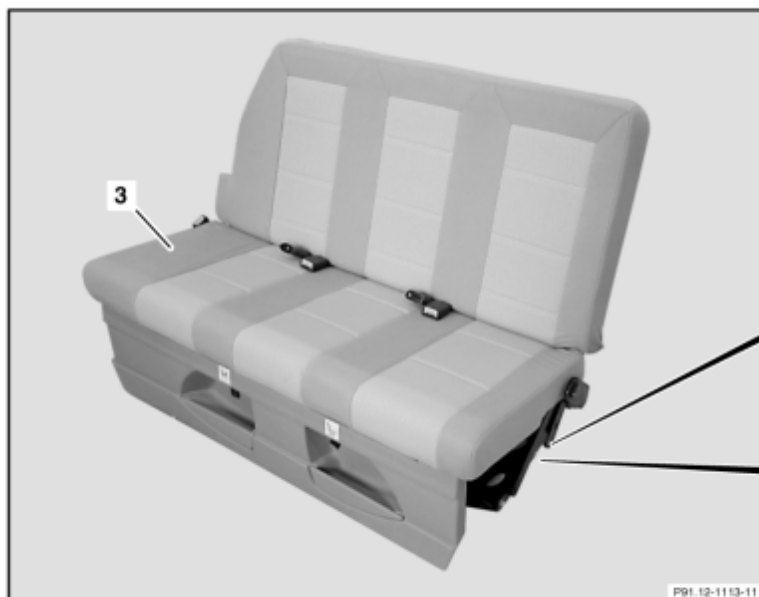

D91.12-1112-09

1 Screw

2 Sliding block bracket

3 Bench seat

4 Sliding block

5 Nuts

☒ ☒	Remove/Install		
⚠ Danger!	Risk of injury caused by body parts becoming jammed, pinched or severed by doors, covers, flaps or by loose components	Keep body parts well clear when moving doors, covers, flaps and components. Wear protective gloves and protective shoes.	AS00.00-Z-0025-01A
1	Remove right side paneling from bench seat casing		AR91.21-D-5746A
2	Unscrew bolt (1) at sliding block bracket (2)	i Installation: Bolt (1) is not tightened until the adjustment operation.	
3	Tilt bench seat (3) backwards		
4	Remove sliding block (4) with sliding block bracket (2)		

5	Unscrew nuts (5).	i Installation: Nuts (5) are not tightened until the adjustment operation.	
6	Remove sliding block (4) from sliding block bracket (2)		
7	Install in the reverse order		
8	Adjust sliding block (4)		AR91.21-D-4040-01B
		Nm Bolt, rear sliding block bracket to seat bench	BA91.12-N-1010-03A
		Nm Nut, sliding block to bench seat	BA91.12-N-1011-03A

Nm **Rear seats**

Number	Designation			Model 903.662 with code ZU8, Z29
BA91.12-N-1010-03A	Bolt, rear sliding block bracket to seat bench		Nm	39
BA91.12-N-1011-03A	Nut, sliding block to bench seat		Nm	20

MODEL 903.662

with CODE (ZU8) National version for USA

with CODE (Z29) "James Cook" touring camper, NAFTA

- 1 Screw
- 2 Washers
- 3 Sleeve
- 4 Control cables
- 5 Adjustment lever
- 6 Protective cap

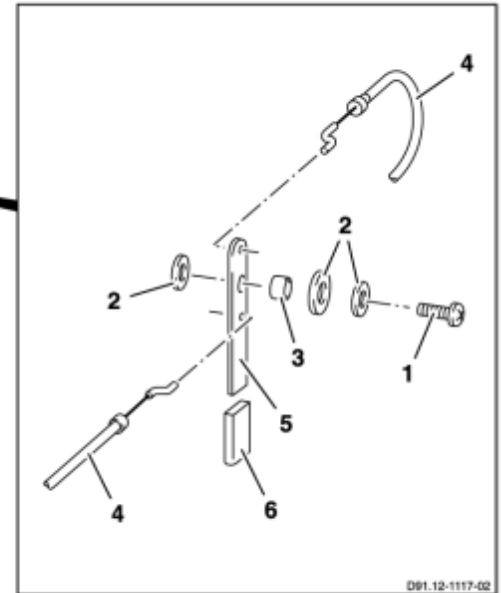

D91.12-1115-06

☒ ☒	Remove/Install		
⚠ Danger!	Risk of injury caused by body parts becoming jammed, pinched or severed by doors, covers, flaps or by loose components	Keep body parts well clear when moving doors, covers, flaps and components. Wear protective gloves and protective shoes.	AS00.00-Z-0025-01A
1	Remove front trim from seat bench housing		AR91.21-D-5745A
2	Remove screw (1)		
3	Remove shims (2) and sleeve (3) simultaneously		
4	Unhook Bowden cables (4) from adjustment lever (5)		
5	Remove adjustment lever (5)		
6	Detach protective cap (6)		
7	Install in the reverse order		

MODEL 903.662

with CODE (ZU8) National version for USA

with CODE (Z29) "James Cook" touring camper, NAFTA

Right Bowden cable

1 Nut

2 Control cable

3 Nut

4 Screw

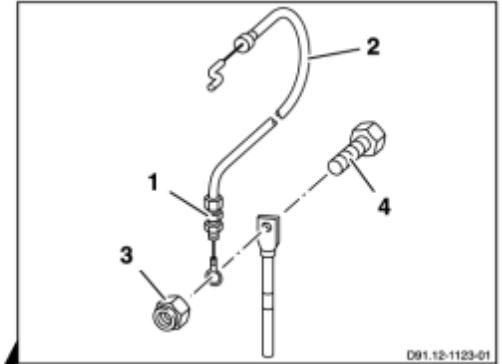

D91.12-1121-06

☒ ☒	Remove/Install		
⚠ Danger!	Risk of injury caused by body parts becoming jammed, pinched or severed by doors, covers, flaps or by loose components	Keep body parts well clear when moving doors, covers, flaps and components. Wear protective gloves and protective shoes.	AS00.00-Z-0025-01A
1	Remove bench seat adjustment lever		AR91.21-D-4050A
2	Slacken nut (1)	<input type="checkbox"/> When renewing the Bowden cable (2), apply the setting from the old Bowden cable (2) to the new one.	
3	Unscrew nut (3) from screw (4)		
4	Remove screw (4)		
5	Unhook control cable (2)		
6	Remove Bowden cable (2)		

7	Install in the reverse order		
8	Perform a function test	i Adjust Bowden cable (2) if necessary.	

MODEL 903.662

with CODE (ZU8) National version for USA

with CODE (Z29) "James Cook" touring camper, NAFTA



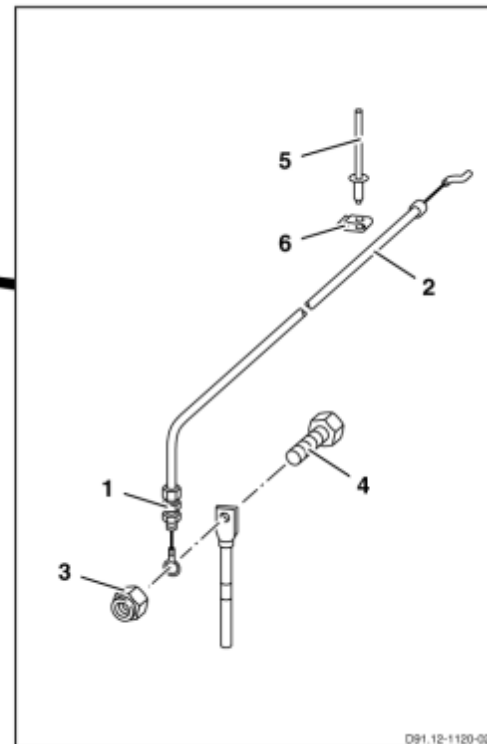

Left Bowden cable

- 1 Nut
- 2 Control cable
- 3 Nut
- 4 Screw
- 5 Pop rivet
- 6 Nail-type clamp



D91.12-1118-06

	Remove		
Danger!	Risk of injury caused by body parts becoming jammed, pinched or severed by doors, covers, flaps or by loose components	Keep body parts well clear when moving doors, covers, flaps and components. Wear protective gloves and protective shoes.	AS00.00-Z-0025-01A
1	Remove bench seat adjustment lever		AR91.21-D-4050A
2	Slacken nut (1)	When renewing the Bowden cable (2), apply the setting from the old Bowden cable (2) to the new one.	
3	Unscrew nut (3) from screw (4)		
4	Remove screw (4)		
5	Drill out blind rivet (5)	Drill (electric/pneumatic)	WE58.40-Z-1001- _____

			03A
		Wet/dry vacuum cleaner	WE58.40-Z-1005-03A
6	Remove nail-type clamp (6)		
7	Remove Bowden cable (2)		
	Install		
8	Install Bowden cable (2)		
9	Fit bolt (4)		
10	Tighten nut (3) on bolt (4)		
11	Tighten nut (1)		
12	Install nail-type clamp (6)		
13	Rivet in blind rivet (5)		
	General information on riveting	Model 168, 169, 171, 199, 203, 209, 211, 215, 219, 230, 240, 414, 639, 903	AH60.00-P-0003-01N
		 PowerBird blind rivet tool	WH58.30-Z-1003-29A
		 Hand riveter	WH58.30-Z-1005-29A
		Blind rivet 3.2×7.9	BR00.45-Z-1013-13A
14	Install adjustment lever on bench seat		AR91.21-D-4050A
15	Operational check	 Adjust Bowden cable (2) if necessary.	

Commercially available tools (see Workshop Equipment Manual)

Number	Designation	Make (e. g.)	Order number
WH58.30-Z-1003-29A	PowerBird blind rivet tool	Gesipa Blindniettechnik GmbH Nordenstraße 13-39 D-64546 Mörfelden - Walldorf	72 400 31
WH58.30-Z-1005-29A	Manual riveting pliers	Gesipa Blindniettechnik GmbH Nordenstraße 13-39 D-64546 Mörfelden -	70 100 01

Workshop equipment/MB testers (see Workshop Equipment Manual)

WE58.40-Z-1001-03A	Drill (electric/pneumatic)
WE58.40-Z-1005-03A	Wet/dry vacuum cleaner

Auxiliary repair materials

Number	Designation	Order number
BR00.45-Z-1013-13A	Blind rivet 3.2x7.9	A 002 990 80 97

MODEL 903.662

with CODE (ZU8) National version for USA

with CODE (Z29) "James Cook" touring camper, NAFTA

1 Seat cushion

2 Bolts

3 Stops



D91.12-1103-06

☒ ☒	Remove/Install		
⚠ Danger!	Risk of injury caused by body parts becoming jammed, pinched or severed by doors, covers, flaps or by loose components	Keep body parts well clear when moving doors, covers, flaps and components. Wear protective gloves and protective shoes.	AS00.00-Z-0025-01A
1	Release seat bolster (1) and fold up	[i] See Operator's Manual	
2	Unscrew bolts (2)	[i] When replacing the left rabbet, fasten seat bolster (1) in place.	
3	Remove stop (3)		
4	Install in the reverse order		

MODEL 903.662

with CODE (ZU8) National version for USA

with CODE (Z29) "James Cook" touring camper, NAFTA

1 Seat cushion

2 Bolts

3 Lock plate

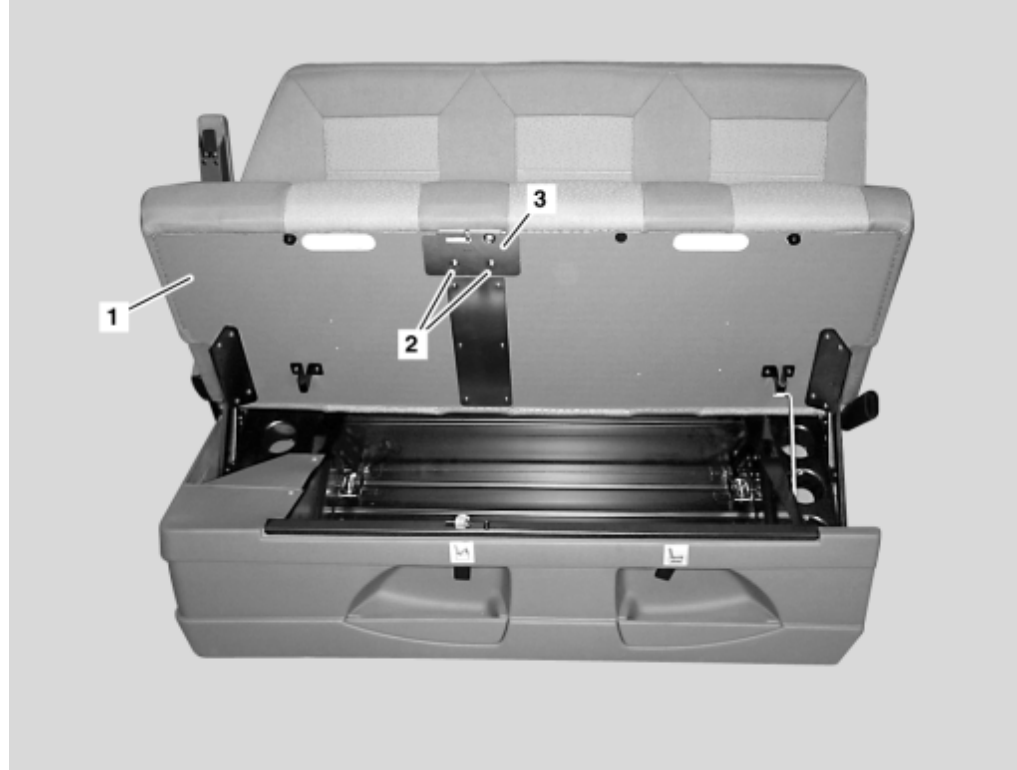

D91.12-1104-06

☒ ☒	Remove/Install		
⚠ Danger!	Risk of injury caused by body parts becoming jammed, pinched or severed by doors, covers, flaps or by loose components	Keep body parts well clear when moving doors, covers, flaps and components. Wear protective gloves and protective shoes.	AS00.00-Z-0025-01A
1	Release seat bolster (1) and fold up	ⓘ See Operator's Manual	
2	Unscrew bolts (2)		
3	Remove lock plate (3)		
4	Install in the reverse order		

MODEL 903.662

with CODE (ZU8) National version for USA

with CODE (Z29) "James Cook" touring camper, NAFTA

1 Seat cushion

2 Bolts

3 Protective plate

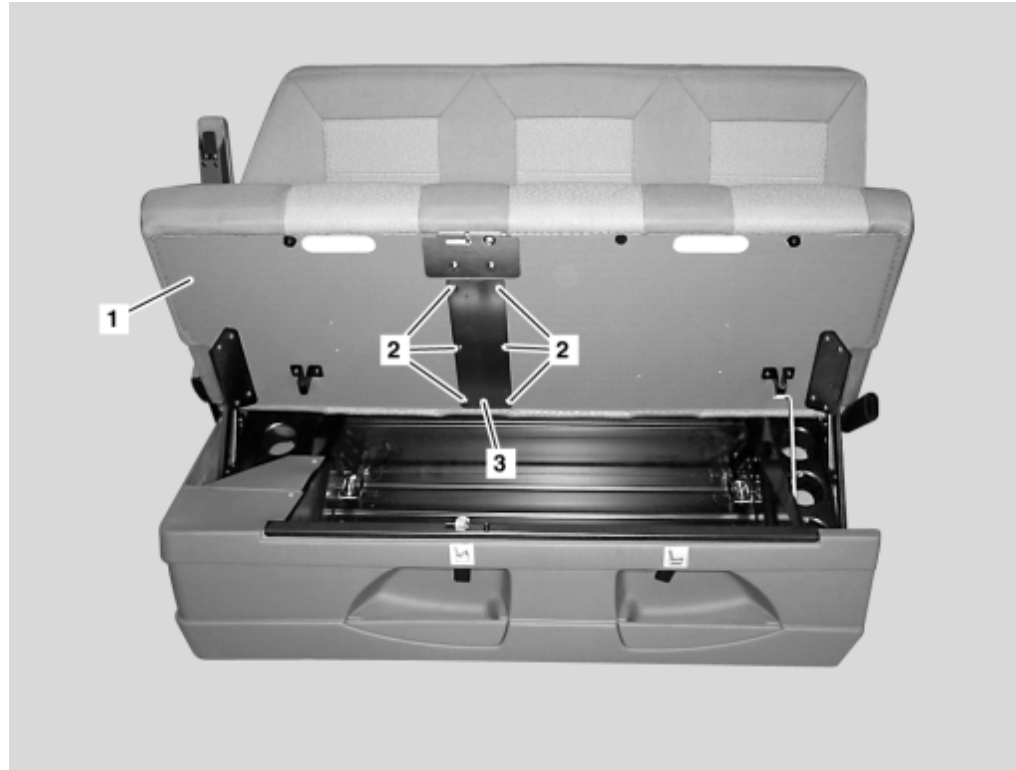

D91.12-1105-06

☒ ☒	Remove/Install		
⚠ Danger!	Risk of injury caused by body parts becoming jammed, pinched or severed by doors, covers, flaps or by loose components	Keep body parts well clear when moving doors, covers, flaps and components. Wear protective gloves and protective shoes.	AS00.00-Z-0025-01A
1	Release seat bolster (1) and fold up	[i] See Operator's Manual	
2	Unscrew bolts (2)		
3	Remove guard plate (3)		
4	Install in the reverse order		

MODEL 903.662

with CODE (ZU8) National version for USA

with CODE (Z29) "James Cook" touring camper, NAFTA

- 1 Bench seat
- 2 Seat cushion
- 3 Nut
- 4 Screw
- 5 Circlip
- 6 Washer
- 7 Compression spring
- 8 Index bolt

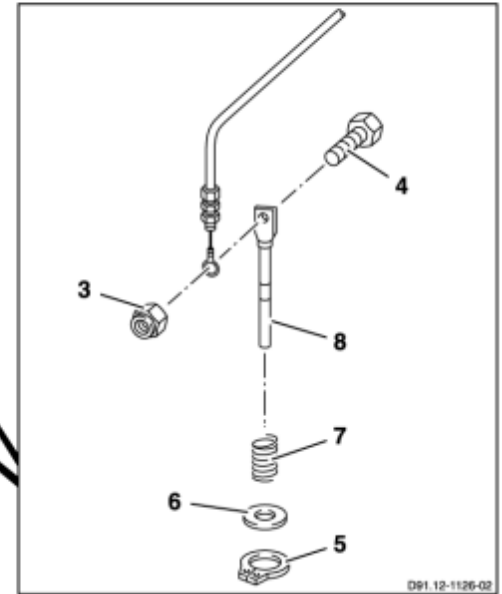
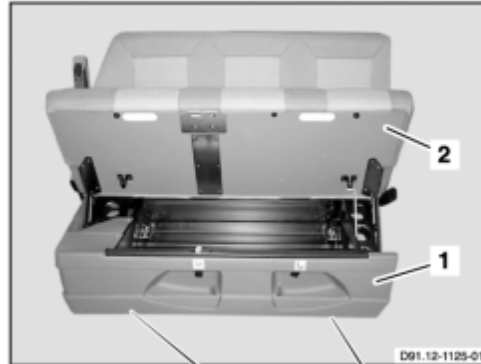

D91.12-1124-06

☒ ☒	Remove/Install		
⚠ Danger!	Risk of injury caused by body parts becoming jammed, pinched or severed by doors, covers, flaps or by loose components	Keep body parts well clear when moving doors, covers, flaps and components. Wear protective gloves and protective shoes.	AS00.00-Z-0025-01A
1	Remove bench seat (1)		AR91.21-D-4000A
2	Release seat bolster (2) and fold up	i See Operator's Manual	
3	Adjust nut (3) on bolt (4) downwards		
4	Remove screw (4)		
5	Tilt bench seat (1) to rear		
6	Remove locking ring (5)		
7	Remove shim (6)		

8	Remove compression spring (7)		
9	Withdraw index bolt (8) upwards		
10	Install in the reverse order		

MODEL 903.662

with CODE (ZU8) National version for USA

with CODE (Z29) "James Cook" touring camper, NAFTA

1 Seat cushion

2 Bolts

3 Rubber buffer

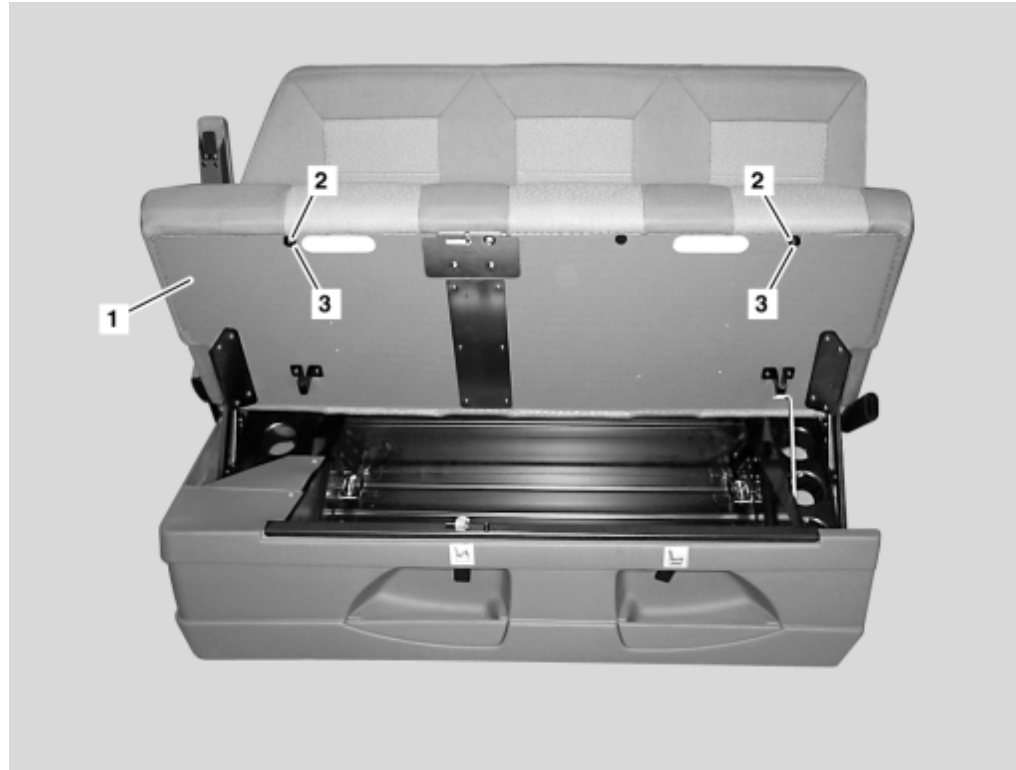

D91.12-1106-06

☒ ☒	Remove/Install		
⚠ Danger!	Risk of injury caused by body parts becoming jammed, pinched or severed by doors, covers, flaps or by loose components	Keep body parts well clear when moving doors, covers, flaps and components. Wear protective gloves and protective shoes.	AS00.00-Z-0025-01A
1	Release seat bolster (1) and fold up	i See Operator's Manual	
2	Unscrew bolts (2)		
3	Remove rubber damper (3)		
4	Install in the reverse order		

MODEL 903.662

with CODE (ZU8) National version for USA

with CODE (Z29) "James Cook" touring camper, NAFTA

1 Seat cushion

2 Screw

3 Support



D91.12-1108-06

☒ ☒	Remove/Install		
⚠ Danger!	Risk of injury caused by body parts becoming jammed, pinched or severed by doors, covers, flaps or by loose components	Keep body parts well clear when moving doors, covers, flaps and components. Wear protective gloves and protective shoes.	AS00.00-Z-0025-01A
1	Release seat bolster (1) and fold up	ⓘ See Operator's Manual	
2	Fasten seat bolster (1) in place		
3	Unscrew bolt (2).		
4	Remove support brace (3)		
5	Install in the reverse order		

MODEL 903.662

with CODE (ZU8) National version for USA

with CODE (Z29) "James Cook" touring camper, NAFTA

1 Back cushion

2 Bolts

4 Bolts

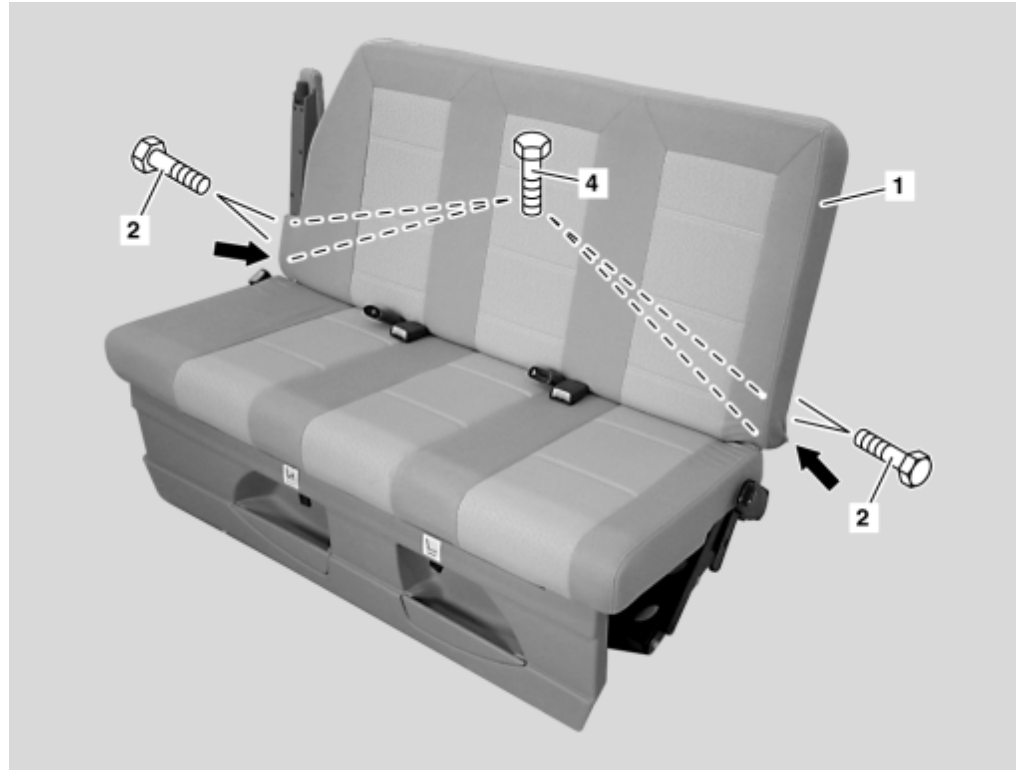

D91.21-0002-06

☒ ☒	Remove/Install		
⚠ Danger!	Risk of injury caused by body parts becoming jammed, pinched or severed by doors, covers, flaps or by loose components	Keep body parts well clear when moving doors, covers, flaps and components. Wear protective gloves and protective shoes.	AS00.00-Z-0025-01A
1	Remove bench		AR91.21-D-4000A
2	Fold armrest upward		
3	Unhook cushion upholstery at side and push to one side	i See arrows.	
4	Unscrew bolts (2)		
5	Undo bolts (4) on rear of back cushion (1)		
6	Remove back cushion (1)		
7	Install in the reverse order		

MODEL 903.662

with CODE (ZU8) National version for USA

with CODE (Z29) "James Cook" touring camper, NAFTA

1 Bolts

2 Seat cushion



D91.21-0001-06

☒ ☒	Remove/Install		
⚠ Danger!	Risk of injury caused by body parts becoming jammed, pinched or severed by doors, covers, flaps or by loose components	Keep body parts well clear when moving doors, covers, flaps and components. Wear protective gloves and protective shoes.	AS00.00-Z-0025-01A
1	Release seat bolster (2) and fold up	ⓘ See Operator's Manual	
2	Remove bolts (1)		
3	Remove seat cushion (2)		
4	Install in the reverse order		

MODEL 903.662

with CODE (ZU8) National version for USA

with CODE (Z29) "James Cook" touring camper, NAFTA

- 1 Spring
- 2 Notch lever
- 3 Screw
- 4 Washers
- 5 Sleeve
- 6 Protective cap

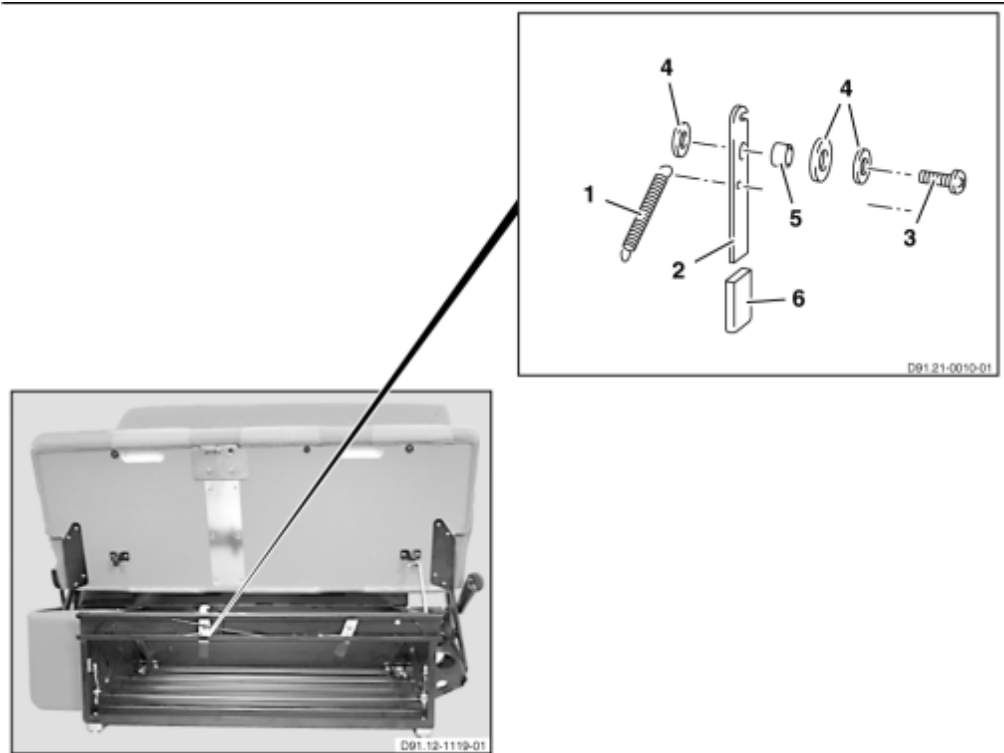

D91.21-0007-06

☒ ☒	Remove/Install		
⚠ Danger!	Risk of injury caused by body parts becoming jammed, pinched or severed by doors, covers, flaps or by loose components	Keep body parts well clear when moving doors, covers, flaps and components. Wear protective gloves and protective shoes.	AS00.00-Z-0025-01A
1	Remove front trim from seat bench housing		AR91.21-D-5745A
2	Unhook spring (1) on notch lever (2)		
3	Remove bolt (3)		
4	Remove shims (4) and sleeve (5) simultaneously		
5	Remove notch lever (2)		
6	Detach protective cap (6)		
7	Install in the reverse order		

MODEL 903.662

with CODE (ZU8) National version for USA

with CODE (Z29) "James Cook" touring camper, NAFTA

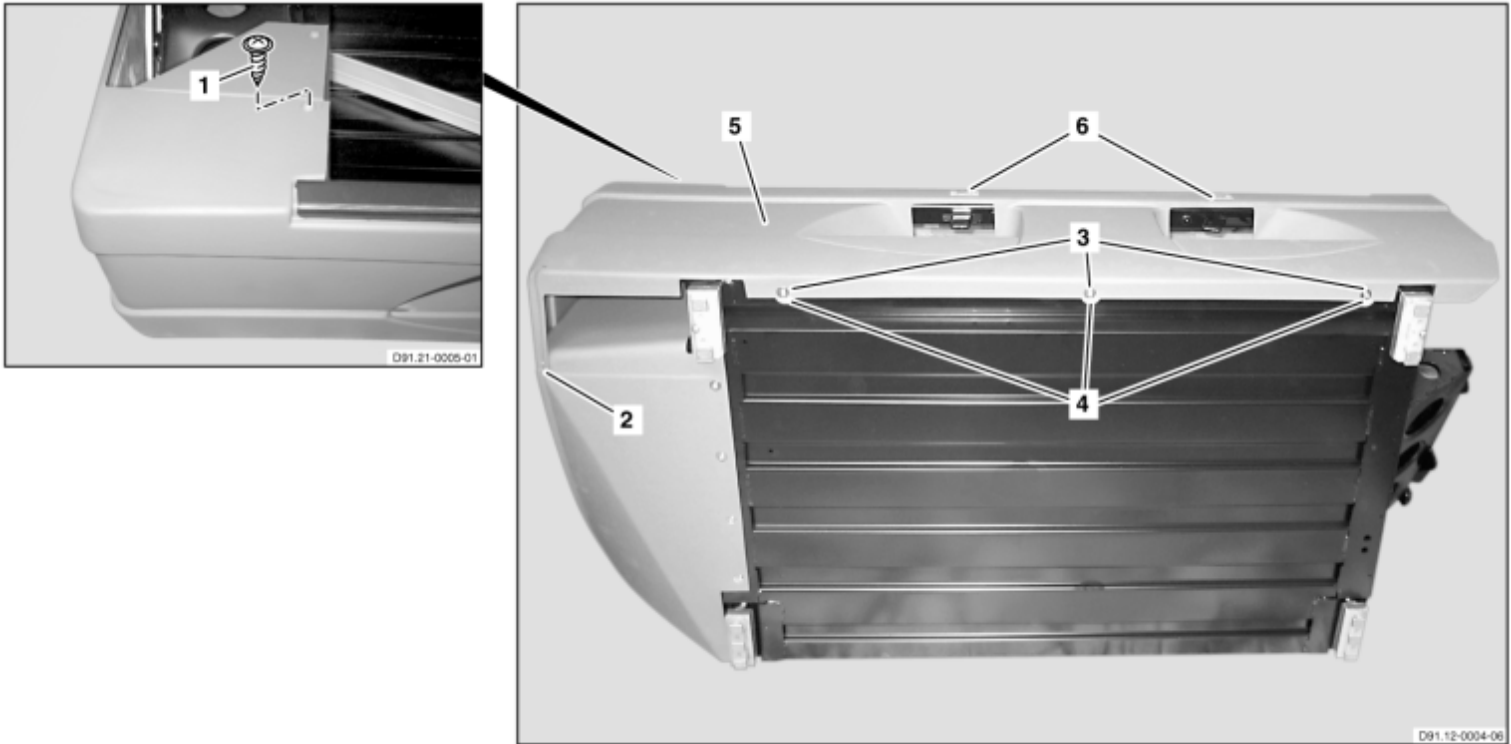





D91.21-0003-09

1 Screw
2 Screw

3 Bolts
4 Plastic disks

5 Trim panel
6 Information labels

	Remove/Install		
 Danger!	Risk of injury caused by body parts becoming jammed, pinched or severed by doors, covers, flaps or by loose components	Keep body parts well clear when moving doors, covers, flaps and components. Wear protective gloves and protective shoes.	AS00.00-Z-0025-01A
1	Remove bench		AR91.21-D-4000A
2	Release seat bolster and fold up	 See Operator's Manual	
3	Remove bolt cap (1)		
4	Remove screw (1)	 Painted shim.	
5	Tilt bench seat to rear		
6	Unscrew bolt (2).	 Bolt (2) is fixed on inside with clamp, which has to be fitted	

		again when reinstalled.	
7	Remove bolts (3)		
8	Remove plastic washers (4)		
9	Remove trim panel (5)	i When replacing panel (5), attach information signs (6).	
10	Install in the reverse order		

MODEL 903.662

with CODE (ZU8) National version for USA

with CODE (Z29) "James Cook" touring camper, NAFTA

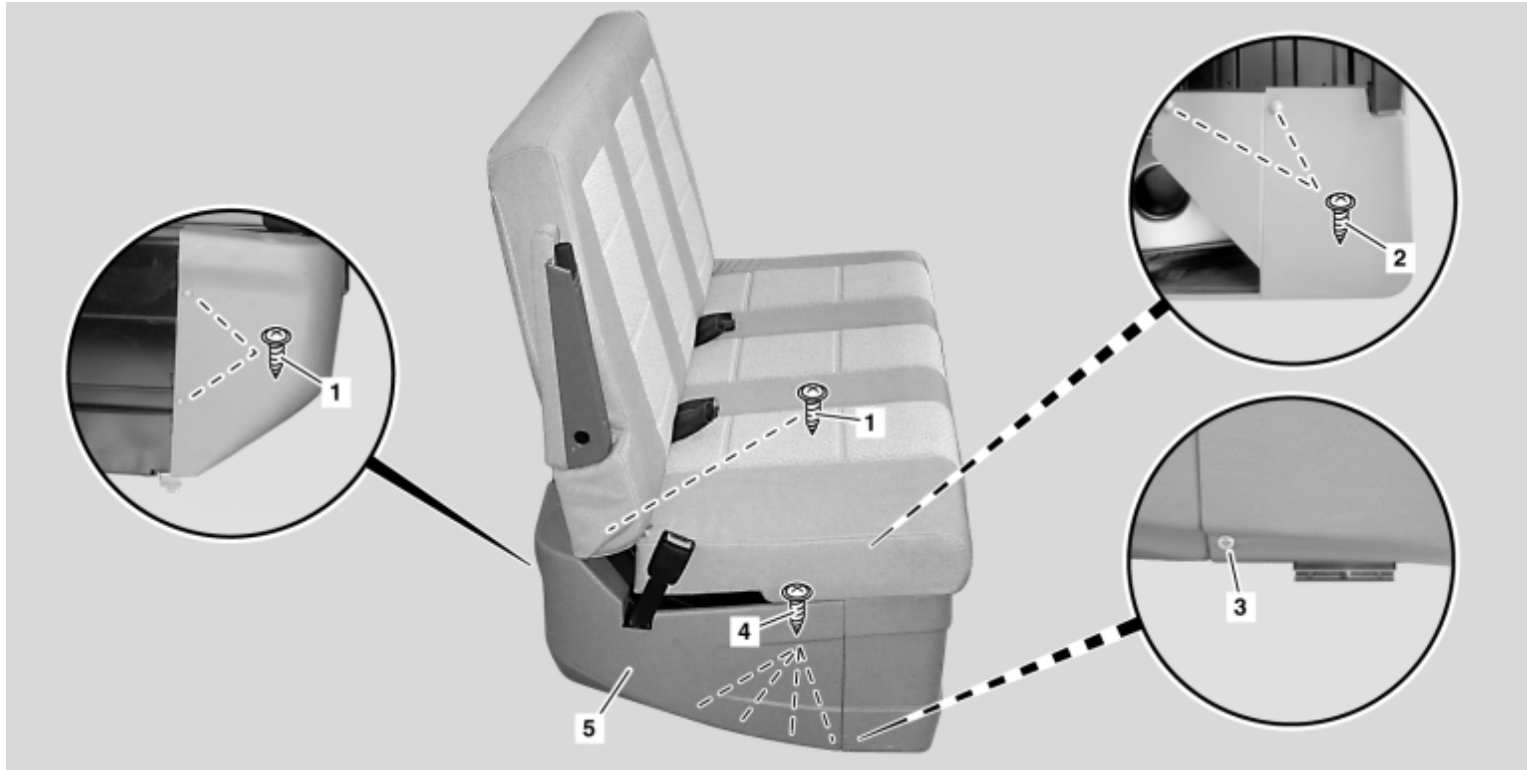

D91.21-0006-09

1 Bolts
2 Bolts3 Screw
4 Bolts

5 Trim panel

☒ ☒	Remove/Install		
⚠ Danger!	Risk of injury caused by body parts becoming jammed, pinched or severed by doors, covers, flaps or by loose components	Keep body parts well clear when moving doors, covers, flaps and components. Wear protective gloves and protective shoes.	AS00.00-Z-0025-01A
1	Remove bench		AR91.21-D-4000A
2	Remove cover caps from screws (1)		
3	Remove bolts (1)	i Painted shims.	
4	Release seat bolster and fold up	i See Operator's Manual	
5	Remove cover caps from screws (2)		

6	Unscrew bolts (2)	i Painted shims.	
7	Tilt bench seat to rear		
8	Remove bolt (3)	i Installation: Bolt (3) fixed on inside with clamp, which has to be fitted again.	
9	Remove bolts (4).		
10	Remove trim panel (5)		
11	Install in the reverse order		

MODEL 903.662

with CODE (ZU8) National version for USA

with CODE (Z29) "James Cook" touring camper, NAFTA

with CODE (H15) Heater for front passenger seat

with CODE (H16) Heater for driver seat

1 Shift gate frame

2 Stowage compartment

3 Screw

4 Trim panel

5 Heated seat connector

S12 Driver heated seat switch

S107 Front passenger heated seat switch

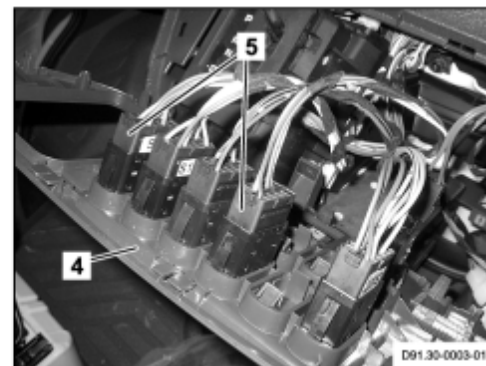

D91.30-0001-06

	Remove/Install		
1	Unclip the shift gate frame(1) and remove	<input checked="" type="checkbox"/> Long wedge	115 589 03 59 00
2	Unclip stowage compartment (2) and remove	<input checked="" type="checkbox"/> Long wedge	115 589 03 59 00
3	Remove bolt (3)		
4	Remove trim panel (4)		
5	Unplug the heated seats connector (5)		
6	Remove the driver heated seat switch (S12), front passenger heated seat switch (S107)		
7	Install in the reverse order		

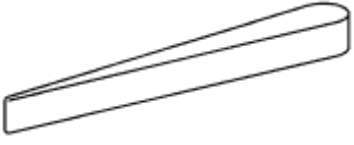

115 589 03 59 00

Longitudinal wedge

MODEL 903.662

with CODE (ZU8) National version for USA

with CODE (Z29) "James Cook" touring camper, NAFTA
Center and right seat belts

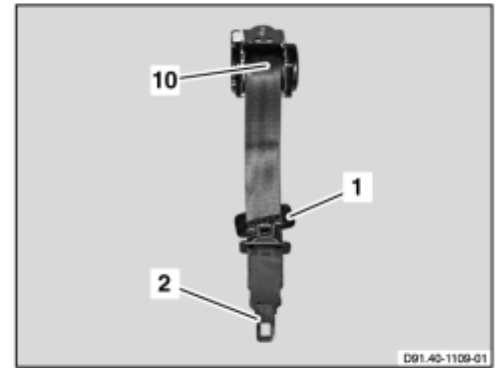
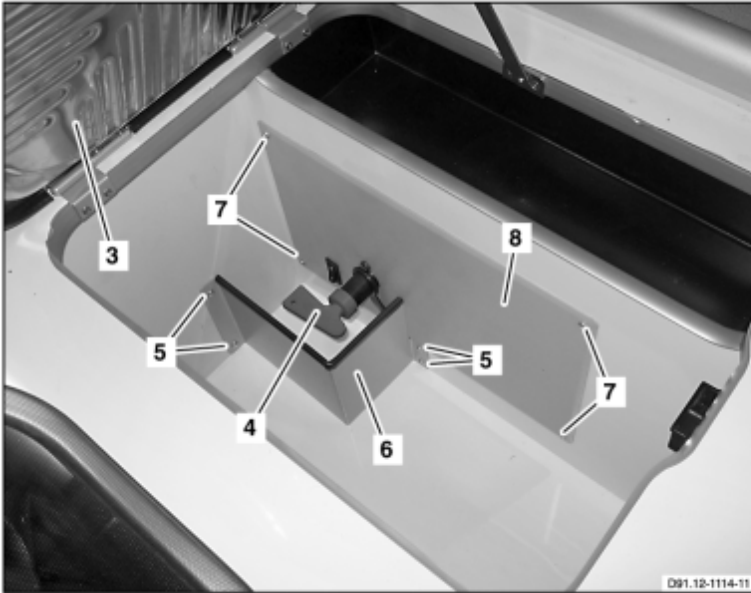

1 Covering
2 Belt buckle
3 Cover
4 12-V main switch

5 Bolts
6 Locking plate
7 Bolts

8 Carrier plate
10 Seat belt

D91.40-1114-09

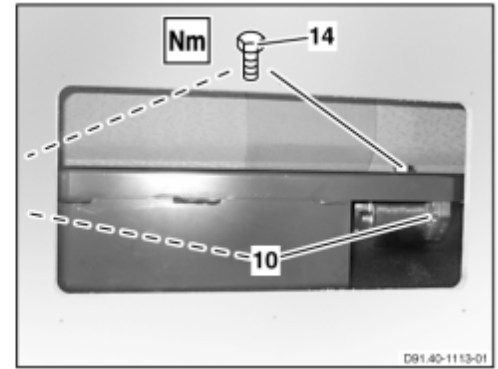
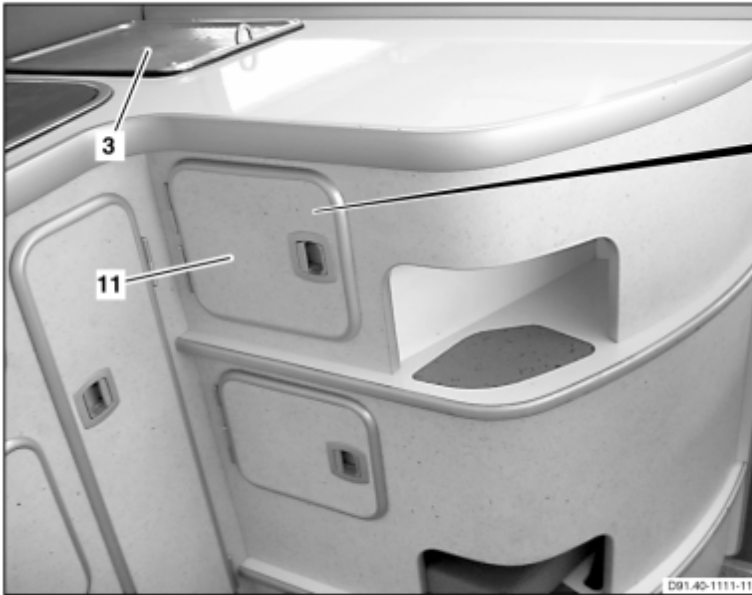

D91.40-1110-09

3 Cover
10 Seat belts

11 Flap
12 Bolts

13 Plate
14 Bolts

	Remove/Install		
Danger!	Risk of injury caused by body parts becoming jammed, pinched or severed by doors, covers, flaps or by loose components	Keep body parts well clear when moving doors, covers, flaps and components. Wear protective gloves and protective shoes.	AS00.00-Z-0025-01A
1	Move bench seat forwards	See Operator's Manual	
2	Unclip cover (1).		
3	Guide covering (1) with belt buckle (2) through belt support opening		
4	Open lid (3)		
5	Turn 12 V main switch (4) to "OFF" position		
6	Unscrew bolts (5).		
7	Remove locking plate (6)		
8	Unscrew bolts (7).		
9	Place carrier plate (8) to one side		
10	Open flap (11)		
11	Unscrew the bolts (12).		

12	Remove plate (13)		
13	Unscrew bolts (14).	Nm Bolt, automatic belt retractor to rear seat	BA91.40-N-1009-01A
14	Remove seat belt (10) towards rear	i Remove middle seat belt (10) through exposed opening of carrier plate (8).	
15	Install in the reverse order		

Nm **Seat belts/emergency tensioning retractors**

Number	Designation	Model
BA91.40-N-1009-01A	Bolt, inertia reel to rear seat	903.662 with code ZU8, Z29
		Nm 38

MODEL 903.662

with CODE (ZU8) National version for USA

with CODE (Z29) "James Cook" touring camper, NAFTA

Left seat belt

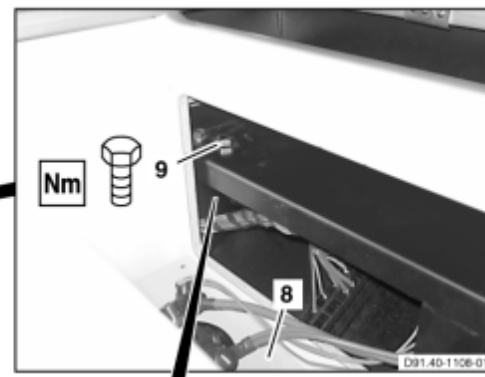
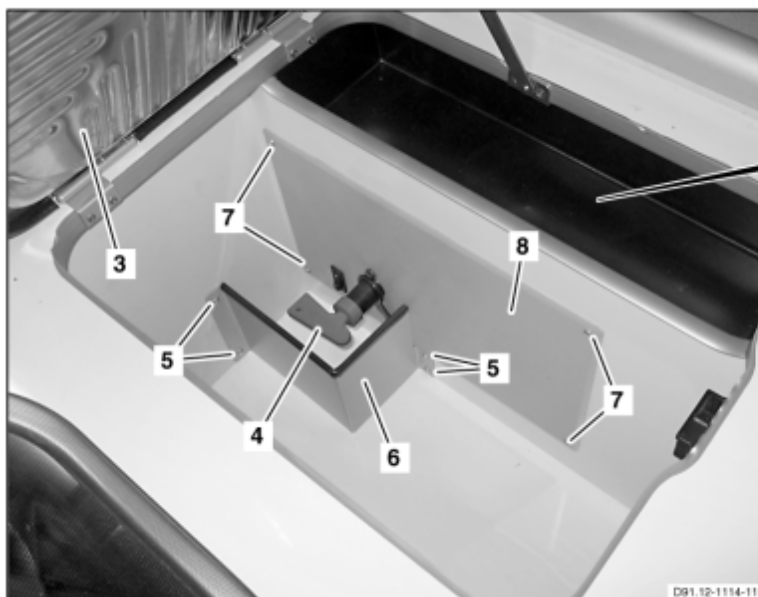

D91.40-1107-09

1 Covering
2 Belt buckle
3 Cover
4 12-V main switch

5 Bolts
6 Locking plate
7 Bolts

8 Carrier plate
9 Screw
10 Seat belt

☒ ☒	Remove/Install		
<p>⚠ Danger!</p>	<p>Risk of injury caused by body parts becoming jammed, pinched or severed by doors, covers, flaps or by loose components</p>	<p>Keep body parts well clear when moving doors, covers, flaps and components. Wear protective gloves and protective shoes.</p>	<p>AS00.00-Z-0025-01A</p>
1	Move bench seat forwards	<p>i See Operator's Manual</p>	
2	Unclip covering (1) at front		
3	Guide covering (1) with belt buckle (2) through belt support opening		
4	Open lid (3)		

5	Turn 12 V main switch (4) to "OFF" position		
6	Unscrew bolts (5).		
7	Remove locking plate (6)		
8	Unscrew bolts (7).		
9	Place carrier plate (8) to one side		
10	Unscrew bolt (9)	Nm Bolt, automatic belt retractor to rear seat	BA91.40-N-1009-01A
11	Remove seat belt (10) towards rear		
12	Install in the reverse order		

 Seat belts/emergency tensioning retractors

Number	Designation		Model 903.662 with code ZU8, Z29
BA91.40-N-1009-01A	Bolt, inertia reel to rear seat		Nm 38

MODEL 903.662

with CODE (ZU8) National version for USA

with CODE (Z29) "James Cook" touring camper, NAFTA

1 Seat cushion

2 Bolts

3 Seat belt buckles

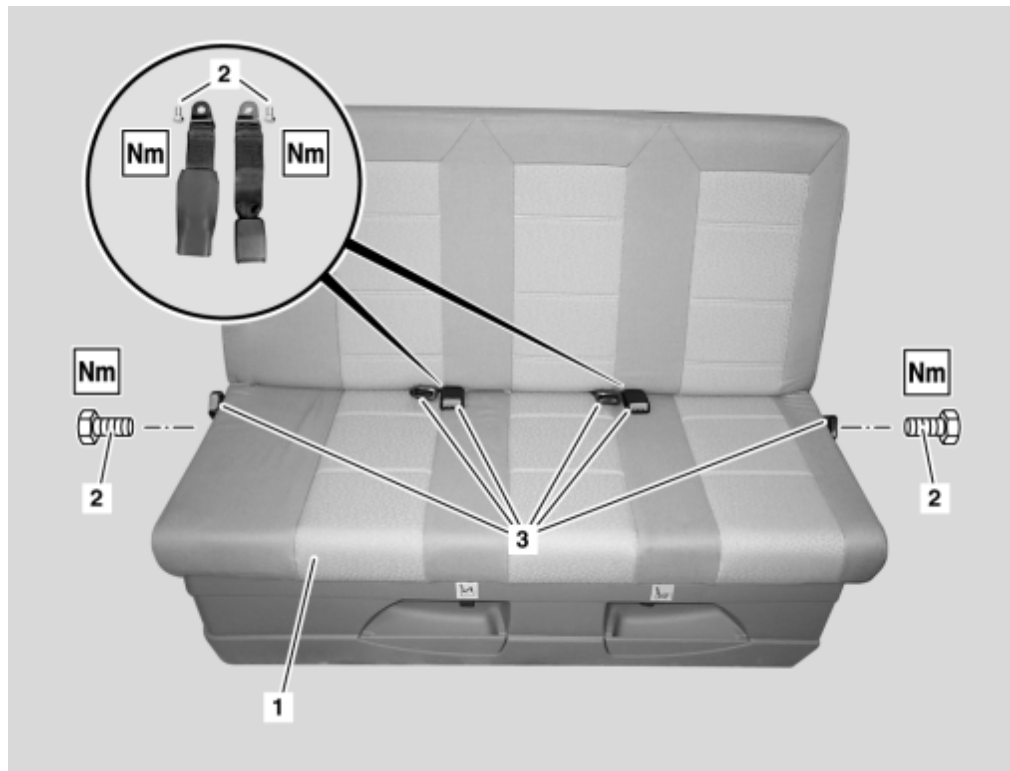

D91.40-1106-06

☒ ☒	Remove/Install		
⚠ Danger!	Risk of injury caused by body parts becoming jammed, pinched or severed by doors, covers, flaps or by loose components	Keep body parts well clear when moving doors, covers, flaps and components. Wear protective gloves and protective shoes.	AS00.00-Z-0025-01A
1.1	Remove panel at right side on bench seat housing	ⓘ Only when removing right seat belt buckles (3).	AR91.21-D-5746A
2.1	Release seat bolster (1) and fold up	ⓘ Only when removing center seat belt buckle (3).	
		ⓘ See Operator's Manual	
3	Unscrew bolts (2)	Nm Screws for seat belt buckle on rear seat	BA91.40-N-1010-01A
4	Remove buckle (3)		
5	Install in the reverse order		

Nm Seat belts/emergency tensioning retractors

Number	Designation		Model 903.662 with code ZU8, Z29
BA91.40-N-1010-01A	Screws for seat belt buckle on rear seat		Nm 38

MODEL 903.662

with CODE (ZU8) National version for USA

with CODE (Z29) "James Cook" touring camper, NAFTA

1 Bed extension
2 Bolts

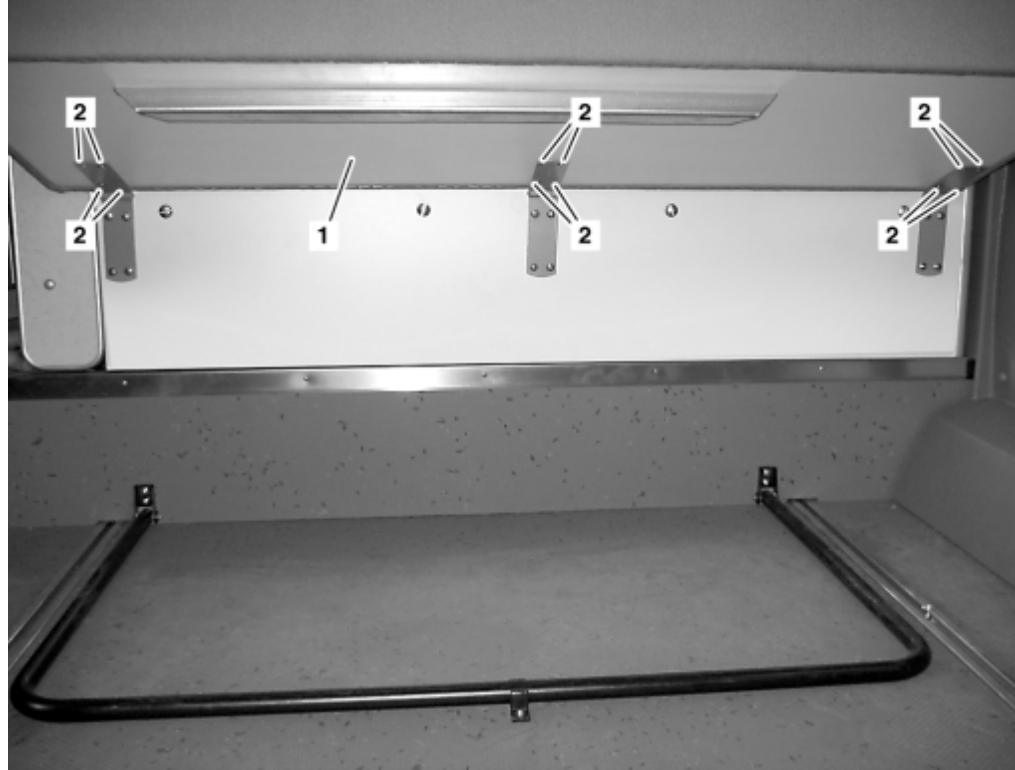

D91.75-0001-06

☒ ☒	Remove/Install		
⚠ Danger!	Risk of injury caused by body parts becoming jammed, pinched or severed by doors, covers, flaps or by loose components	Keep body parts well clear when moving doors, covers, flaps and components. Wear protective gloves and protective shoes.	AS00.00-Z-0025-01A
1	Move bench seat forwards	ⓘ See Operator's Manual	
2	Fold up bed extension (1)		
3	Unscrew bolts (2)		
4	Remove bed extension (1)		
5	Install in the reverse order		

MODEL 903.662

with CODE (ZU8) National version for USA

with CODE (Z29) "James Cook" touring camper, NAFTA

1 Bed extension

2 Bolts

3 Support brace for bed extension

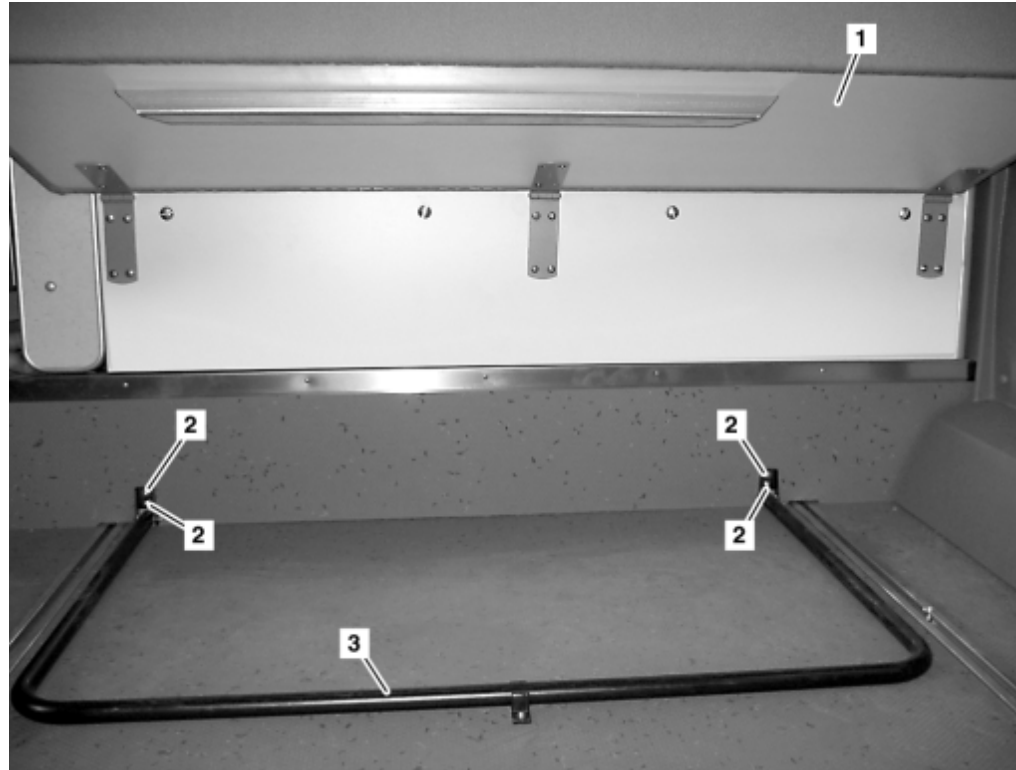

D91.75-0002-06

☒ ☒	Remove/Install		
⚠ Danger!	Risk of injury caused by body parts becoming jammed, pinched or severed by doors, covers, flaps or by loose components	Keep body parts well clear when moving doors, covers, flaps and components. Wear protective gloves and protective shoes.	AS00.00-Z-0025-01A
1	Unlock bench seat and move forward	i See Operator's Manual	
2	Fold up bed extension (1) and fasten in place		
3	Unscrew bolts (2)		
4	Remove support brace for bed extension (3)		
5	Install in the reverse order		

MODEL 903.662

with CODE (ZU8) National version for USA

with CODE (Z29) "James Cook" touring camper, NAFTA

Bench seat

1 Bed extension

2 Support brace for bed extension

3 Bolts

4 Clamping device

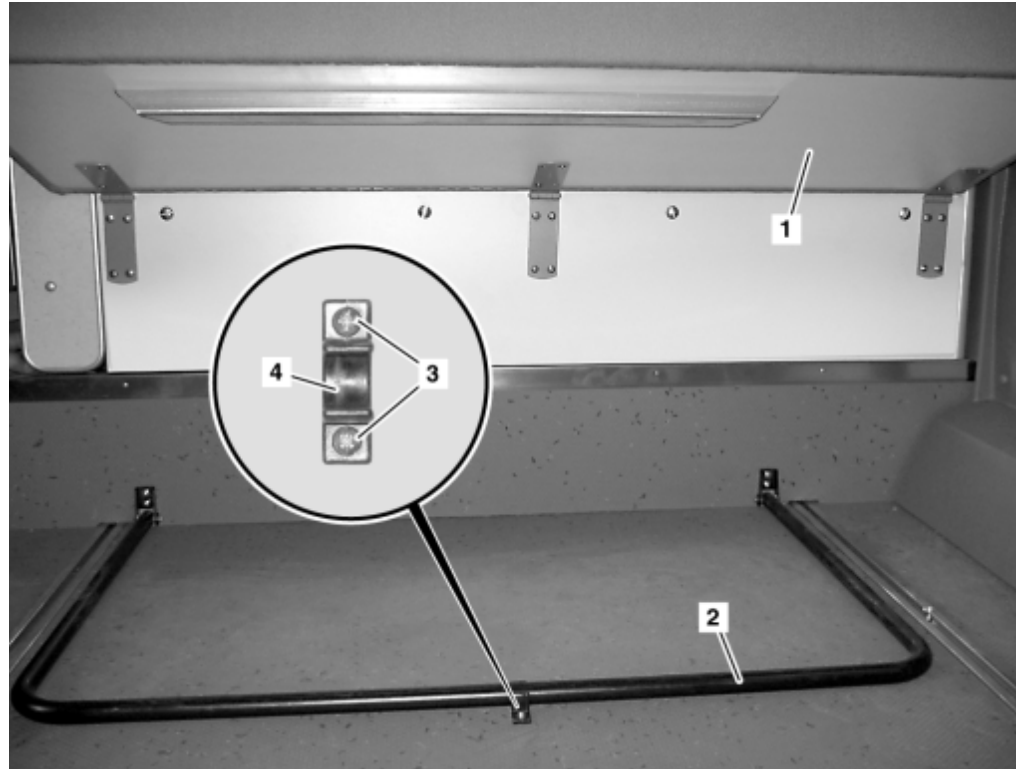

D91.75-0003-06

☒ ☒	Remove/Install		
⚠ Danger!	Risk of injury caused by body parts becoming jammed, pinched or severed by doors, covers, flaps or by loose components	Keep body parts well clear when moving doors, covers, flaps and components. Wear protective gloves and protective shoes.	AS00.00-Z-0025-01A
1	Unlock bench seat and move forward	ⓘ See Operator's Manual	
2	Fold up bed extension (1)		
3	Fold up support brace for bed extension (2) and hook into place		
4	Remove bolts (3)		
5	Remove clamping device (4)		
6	Install in the reverse order		

MODEL 903.662

with CODE (ZU8) National version for USA



with CODE (Z29) "James Cook" touring camper, NAFTA

1 Center bed plate

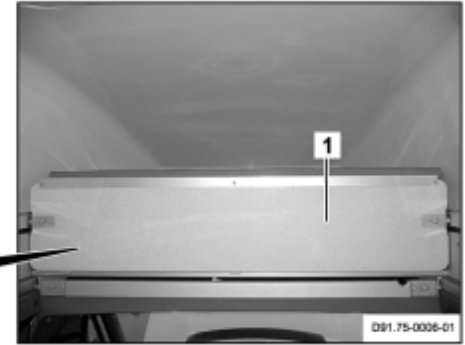
2 Individual suspension module



D91.75-0004-04

	Remove/Install		
 Danger!	Risk of injury caused by body parts becoming jammed, pinched or severed by doors, covers, flaps or by loose components	Keep body parts well clear when moving doors, covers, flaps and components. Wear protective gloves and protective shoes.	AS00.00-Z-0025-01A
1	Unlock and fold down the center bed plate (1)		
2	Fold up bed bolster		
3	Twist individual suspension module (2) and remove		
4	Install in the reverse order		

MODEL 903.662

with CODE (ZU8) National version for USA

with CODE (Z29) "James Cook" touring camper, NAFTA



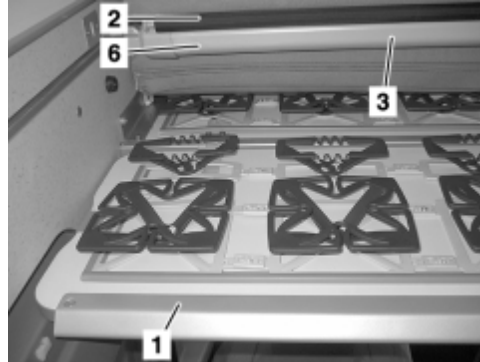

- 1 Center bed plate
- 2 Rear bed plate
- 3 Screw
- 4 Loop hanger
- 5 Bolts
- 6 Protective net

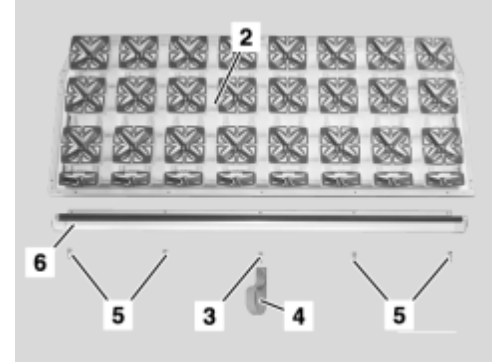

D91.75-0030-01



D91.75-0028-01

	Remove/Install		
 Danger!	Risk of injury due to pinching, crushing or cutting off of limbs or other parts of the body by doors, covers, lids, flaps and other movable components	No limbs or other parts of the body should be within the operating range of the mechanism when moving components (doors, covers, lids, flaps, etc.). Wear protective gloves and work shoes.	AS00.00-Z-0025-01A
1	Unlock and open the center bed plate (1)	 See Operating Instructions	
2	Slide the rear bed plate (2) toward the rear	 See Operating Instructions	
3	Remove bolt (3)		
4	Remove the loop hanger (4)		
5	Unscrew bolts (5).		
6	Remove the protective net (6)		
7	Install in the reverse order		

MODEL 903.662

with CODE (ZU8) National version for USA

with CODE (Z29) "James Cook" touring camper, NAFTA
protective net for high roof bed

1 Screw

2 Bracket for protective net

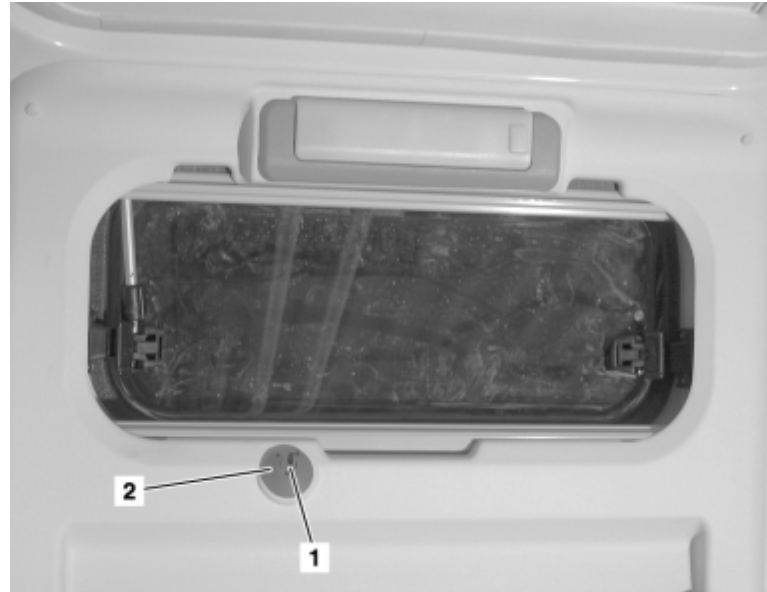

D91.75-0029-11

☒ ☒	Remove/Install		
1	Remove bolt (1)		
2	Remove bracket for protective net (2)		
3	Install in the reverse order		

MODEL 903.662

with CODE (ZU8) National version for USA

with CODE (Z29) "James Cook" touring camper, NAFTA

rear bed plate

1 Rear bed plate

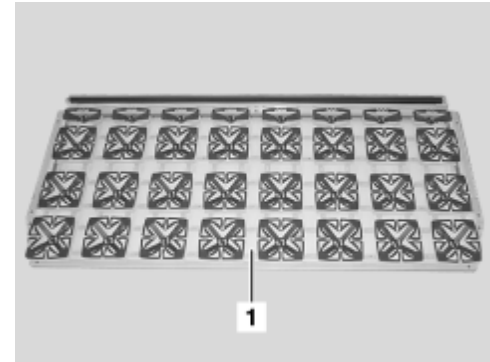

D91.75-0025-01

☒ ☒	Remove/Install		
⚠ Danger!	Risk of injury due to pinching, crushing or cutting off of limbs or other parts of the body by doors, covers, lids, flaps and other movable components	No limbs or other parts of the body should be within the operating range of the mechanism when moving components (doors, covers, lids, flaps, etc.). Wear protective gloves and work shoes.	AS00.00-Z-0025-01A
1	Remove bed plate guide rollers		AR91.75-D-7760A
2	Open the vent window on the right side of the high roof		
3	Remove the rear bed plate (1)	i Position the rear bed plate (1) at an angle as shown and remove it (let one corner of the rear bed plate (1) extend through the opening of the right vent window).	
4	Install in the reverse order		

MODEL 903.662

with CODE (ZU8) National version for USA

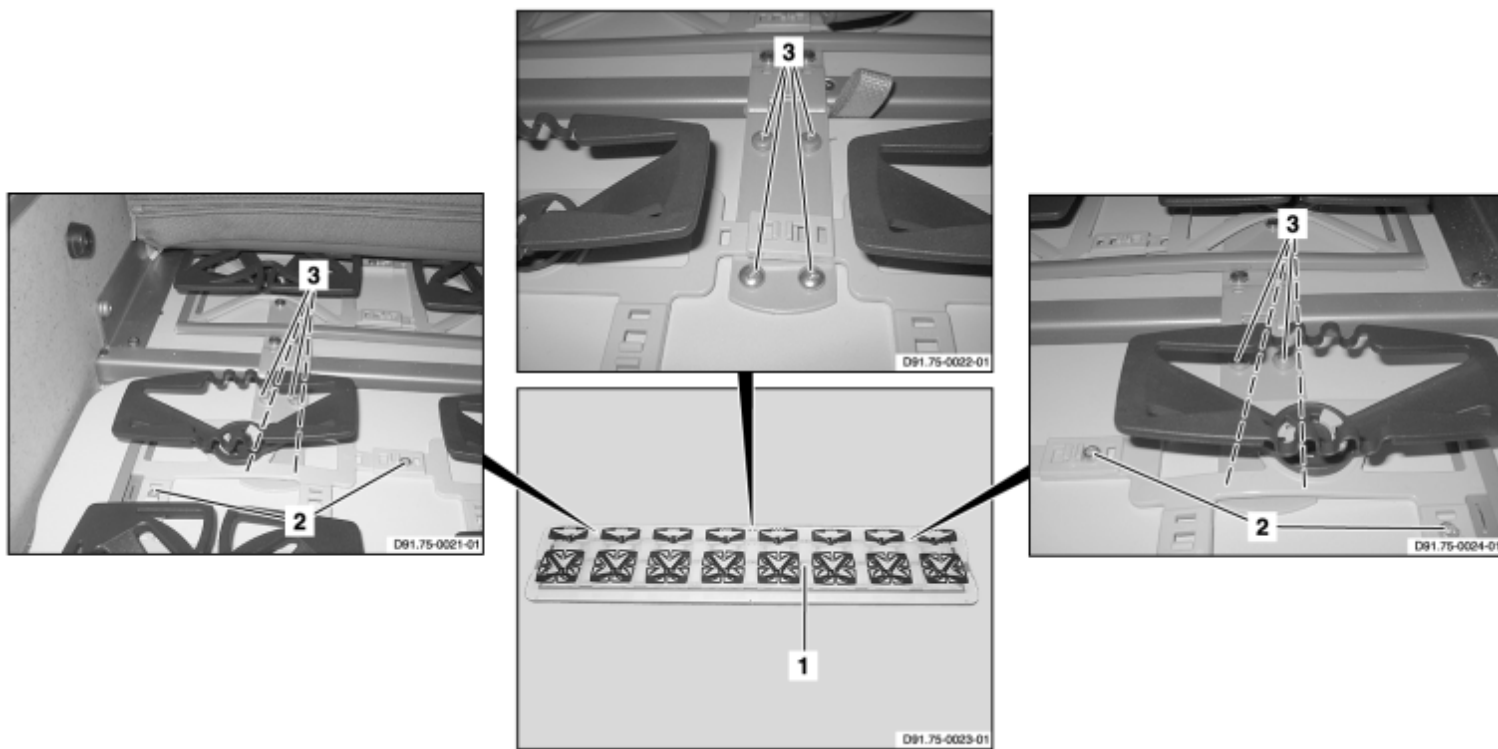

with CODE (Z29) "James Cook" touring camper, NAFTA
center bed plate

D91.75-0020-09

1 Center bed plate

2 Bolts

3 Bolts

	Remove/Install		
 Danger!	Risk of injury due to pinching, crushing or cutting off of limbs or other parts of the body by doors, covers, lids, flaps and other movable components	No limbs or other parts of the body should be within the operating range of the mechanism when moving components (doors, covers, lids, flaps, etc.). Wear protective gloves and work shoes.	AS00.00-Z-0025-01A
1	Unlock and fold down the center bed plate (1)		
2	Unscrew bolts (2)		
3	Remove bolts (3)		
4	Remove center bed plate (1)		
5	Install in the reverse order		



MODEL 903.662

with CODE (ZU8) National version for USA

with CODE (Z29) "James Cook" touring camper, NAFTA front bed plate

- 1 Bolts
- 2 Bolts
- 3 Bracket
- 5 Front bed plate

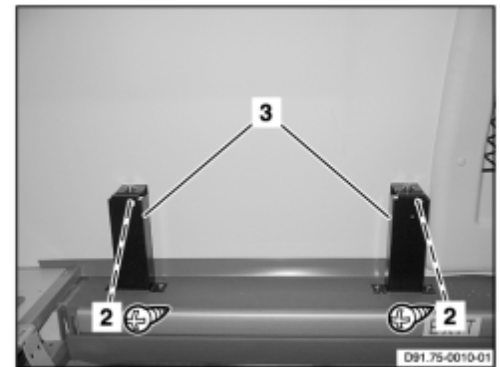
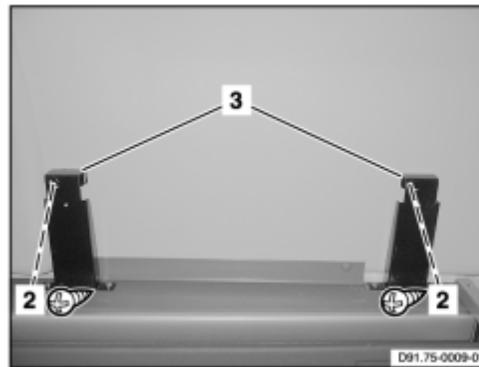
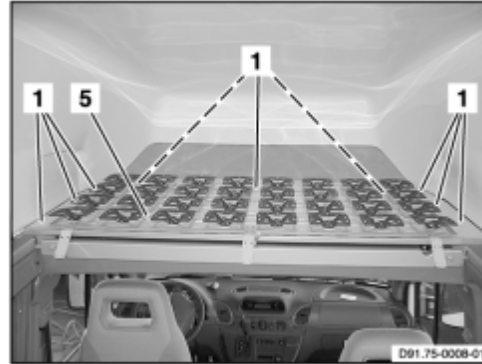

D91.75-0007-06

- 4 Right vent window
- 5 Front bed plate



D91.75-0011-01

	<p>Remove/Install</p>		
<p>⚠ Danger!</p>	<p>Risk of injury due to pinching, crushing or cutting off of limbs or other parts of the body by doors, covers, lids, flaps and other movable components</p>	<p>No limbs or other parts of the body should be within the operating range of the mechanism when moving components (doors, covers, lids, flaps, etc.). Wear protective</p>	<p>AS00.00-Z-0025-01A</p>

		gloves and work shoes.	
1	Remove bed plate	Rear bed plate	AR91.75-D-7755A
2	Remove bed plate	Center bed plate	AR91.75-D-7755B
3	Removing the guide rail	Left guide rail	AR91.75-D-7765A
4	Removing the guide rail	Right guide rail	AR91.75-D-7765B
5	Remove trim from the right side of the vent window	Side vent window for high roof	AR68.30-D-1550A
6	Remove screws (1)		
7	Remove screws (2) from bracket (3)		
8	Remove bracket (3)		
9	Open the right vent window (4) and secure it in place		
10	Remove the front bed plate (5)	i The front bed plate (5) must be removed from the vehicle as shown.	
11	Install in the reverse order		

MODEL 903.662

with CODE (ZU8) National version for USA

with CODE (Z29) "James Cook" touring camper, NAFTA
center bed plate

1 Bolts

2 Center bed plate

3 Bolts

4 Lock

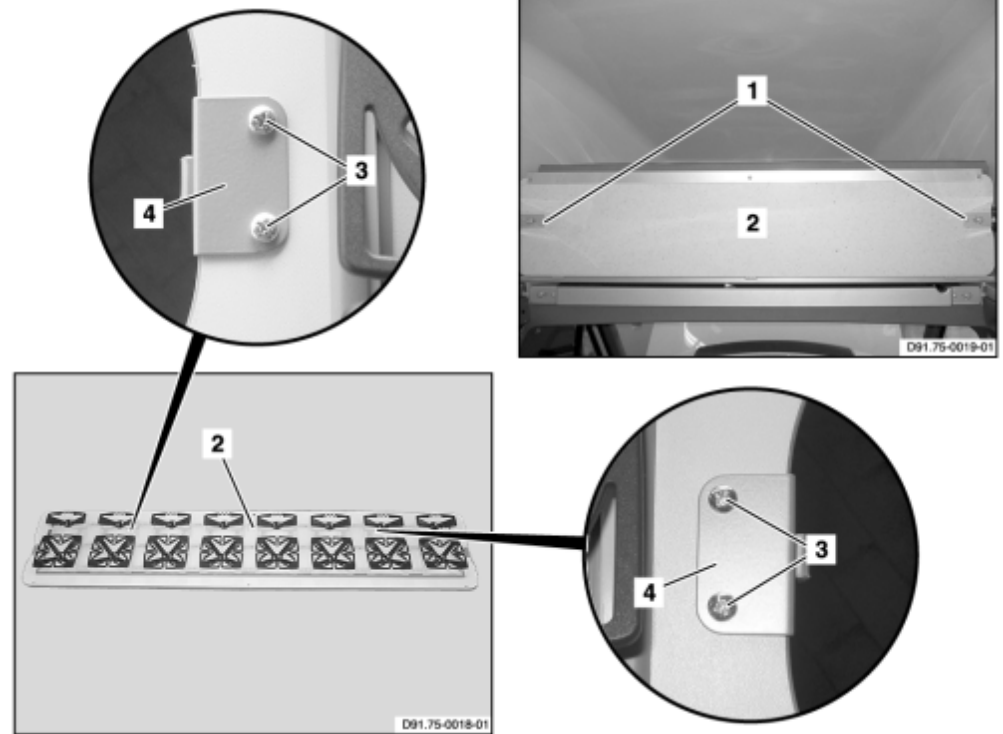

D91.75-0017-06

☒ ☒	Remove/Install		
1	Remove screws (1)		
2	Unlock and fold down the center bed plate (2)		
3	Remove bolts (3)		
4	Remove lock (4)		
5	Install in the reverse order		

MODEL 903.662

with CODE (ZU8) National version for USA



with CODE (Z29) "James Cook" touring camper, NAFTA
center bed plate

1 Bolts

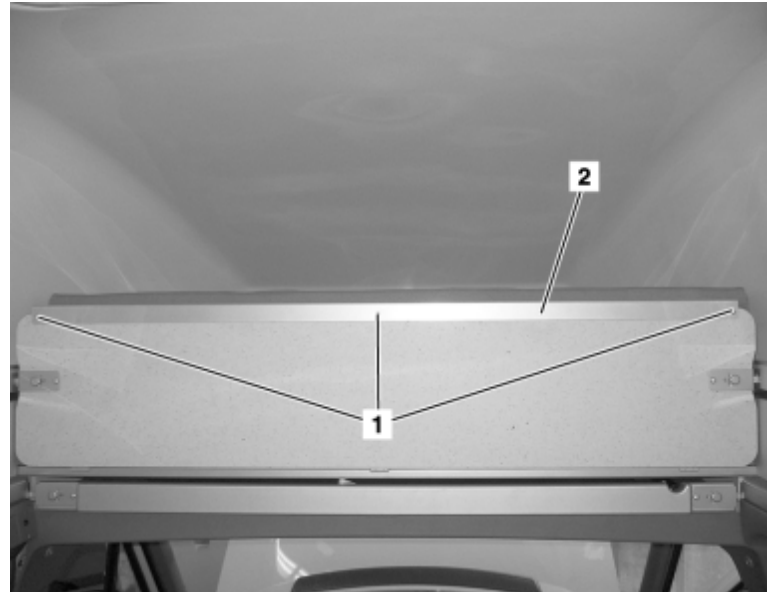
2 Protective strip



D91.75-0016-11

 	Remove/Install		
1	Remove screws (1)		
2	Remove protective molding (2).		
3	Install in the reverse order		

MODEL 903.662

with CODE (ZU8) National version for USA

with CODE (Z29) "James Cook" touring camper, NAFTA

1 Center bed plate

2 Bed padding

3 Rear bed plate

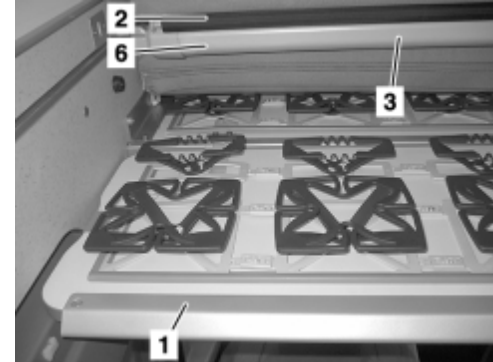

D91.75-0030-01

4 Bolts

5 Guide rollers

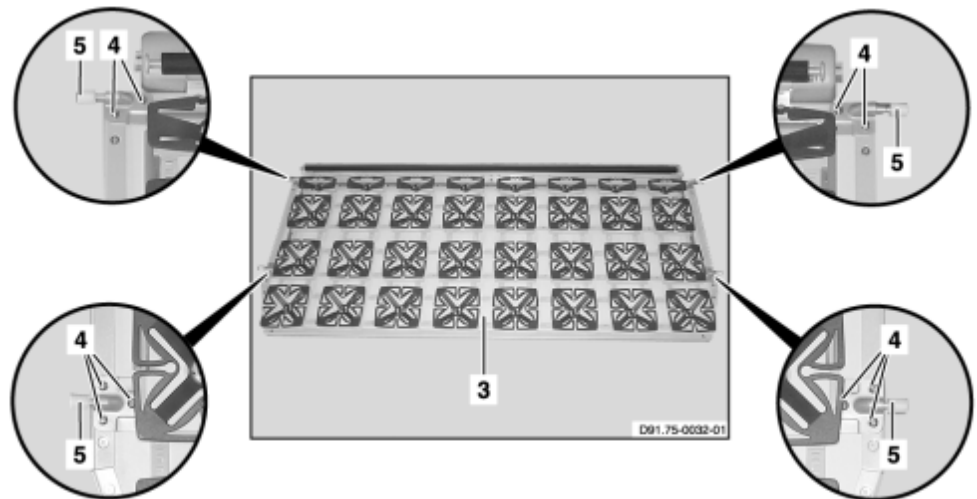

D91.75-0031-05

☒ ☒	Remove/Install		
⚠ Danger!	Risk of injury due to pinching, crushing or cutting off of limbs or other parts of the body by doors, covers, lids, flaps and other movable components	No limbs or other parts of the body should be within the operating range of the mechanism when moving components (doors, covers, lids, flaps, etc.). Wear protective gloves and work shoes.	AS00.00-Z-0025-01A
1	Unlock and open the center bed plate (1)		
2	Remove bed padding (2)		

3	Pull the rear bed plate (3) toward the rear		
4	Remove bolts (4).		
5	Remove the guide rollers (5)		
6	Install in the reverse order		

MODEL 903.662



with CODE (ZU8) National version for USA

with CODE (Z29) "James Cook" touring camper, NAFTA
left guide rail

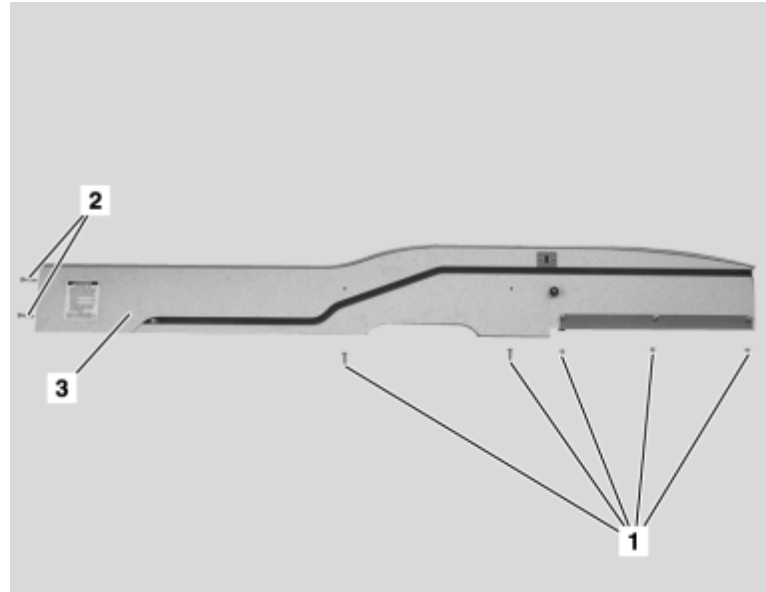
- 1 Bolts
- 2 Bolts
- 3 Guide rail



D91.75-0012-11

 	Remove/Install		
1	Remove bed plate	Rear bed plate	AR91.75-D-7755A
2	Remove bed plate	Center bed plate	AR91.75-D-7755B
3	Remove cover caps from screws (1)		
4	Remove screws (1)		
5	Remove floor in wall cupboard	Lengthwise in wall cupboard	AR86.60-D-0050-01A
6	Unscrew bolts (2)		
7	Remove guide rail (3)		
8	Install in the reverse order		

MODEL 903.662

with CODE (ZU8) National version for USA

with CODE (Z29) "James Cook" touring camper, NAFTA
right guide rail

- 1 Bolts
- 2 Bolts
- 3 Bolts
- 4 Bracket
- 6 Screw
- 8 Guide rail

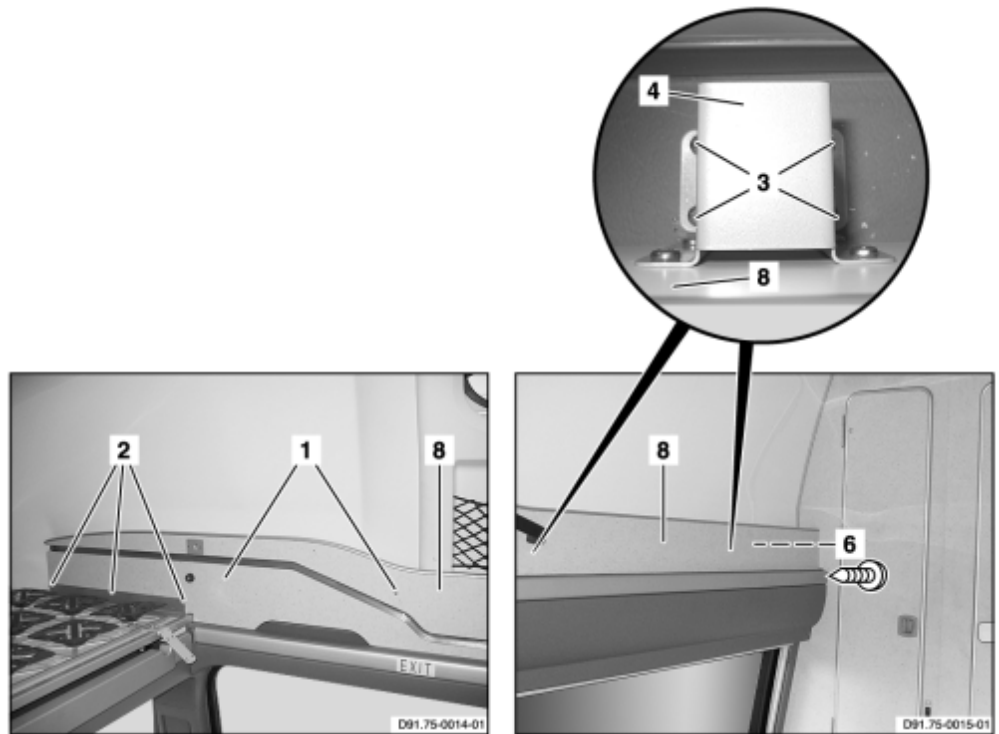

D91.75-0013-06

	Remove/Install		
1	Remove bed plate	Rear bed plate	AR91.75-D-7755A
2	Remove bed plate	Center bed plate	AR91.75-D-7755B
3	Remove cover caps from screws (1)		
4	Remove screws (1)		
5	Unscrew bolts (2)		
6	Remove screws (3) from bracket (4)		
7	Open door of clothes closet		
8	Unscrew bolt (6)		
9	Remove guide rail (8)		

PE68.00-D-2000-99D

[Display in a separate window](#)

To display wiring diagrams, you need a
JAVA 1.1 capable Browser like e.g. "Microsoft Internet Explorer 4.0"
or
"Netscape Navigator 4.05" and higher with AWT 1.1 support

A39/2	Refrigerator box
A97	Camper operating and display unit
A97	Camper operating and display unit
A97	Camper operating and display unit
A97	Camper operating and display unit
A97	Camper operating and display unit
A97	Camper operating and display unit
A97	Camper operating and display unit
B14/3	Additional battery temperature sensor
B14/5	Interior temperature sensor
B146	Gas sensor
B146/1	Wastewater fill level sensor
B146/2	Fresh water fill level sensor
E18	Hot air auxiliary heating control unit
F72	12V fuse strip
F72	12V fuse strip
F72f1	Camper operating and display unit fuse, gas sensor
F72f4	Warm air auxiliary heater fuse
F72f6	Refrigerator box fuse
F73	110V fuse strip
F73	110V fuse strip
F73	110V fuse strip
F73	110V fuse strip
F73	110V fuse strip
F73f1	110V fuse strip prefuse
F73f2	Fault-current circuit breaker

F73f3	Onboard charger fuse, 110V interior socket
F73f4	110V interior socket fuse
F73f5	Air conditioning voltage converter fuse
F80	Onboard charger fuse
F81	Charge line to additional battery fuse
F81/1	Charge line to vehicle battery fuse
G1/1	Additional battery
G1/1	Additional battery
G1/1	Additional battery
H4/7	Left rear speaker
H4/8	Right rear speaker
K52	Additional battery cutoff relay
M16	Metering pump
N83/5	110V/12V onboard charger control unit
N83/5	110V/12V onboard charger control unit
R20	Measuring resistor
S25/20	Main battery switch
S25/20	Main battery switch
U2	MB interface
U2	MB interface
W5	Ground point (seat box)
W29/3	Ground (left C-pillar)
W29/3	Ground (left C-pillar)
W29/3	Ground (left C-pillar)
W29/3	Ground (left C-

pillar)
W29/3 Ground (left C-pillar)
W29/3 Ground (left C-pillar)
W29/9 Ground (right D-pillar)
X5.1 LHD auxiliary heater connector
X5.2 LHD auxiliary heater metering pump connector
X6 Auxiliary heater connector
X58/30 110V interior socket
X58/31 110V interior socket
X58/32 110V interior socket
X156 110V feed socket
X310 Roof air conditioning control unit



PE68.00-D-2000-60D	Legend of wiring diagram for motor caravan	MODEL 903.662 with CODE (Z29) "James Cook" touring camper, NAFTA sheet 1	
--------------------	--	--	--

Code	Designation	Coordinates
A39/2	Refrigerator box	14L
A97	Operating and display unit for camper	2A 9A 16A 23A 30A 37A
B14/3	Additional battery temperature sensor	42L
B14/5	Interior temperature sensor	19L
B146	Gas sensor	9L
B146/1	Fill level sensor for waste water	22L
B146/2	Fill level sensor for fresh water	20L
E18	Hot air auxiliary heating control unit	29L
F72	12 V fuse strip	10F 24F
F72f1	Fuse for operating and display unit for camper, gas sensor	11E
F72f4	Fuse for warm air auxiliary heater	25E
F72f6	Refrigerator box fuse	12E
F73	110 V fuse strip	50H 50F 53F 55F 62F
F73f1	Prefuse for fuse strip 110 V	51H
F73f2	Fault current protection switch	52E
F73f3	Fuse for onboard charger, interior socket 110 V	54E
F73f4	Fuse for interior socket 110 V	57E
F73f5	Fuse for air conditioning voltage transformer	63E
F80	Fuse for onboard charger	46G
F81	Fuse for charge line to additional battery	44F
F81/1	Charge line to vehicle battery fuse	44H
G1/1	Additional battery	11L

		25L 40G
H4/7	Left rear speaker	70L
H4/8	Right rear speaker	68L
K52	Additional battery cutoff relay	47L
M16	Metering pump	34L
N83/5	Onboard charger control unit 110 V/12 V	38A 50A
R20	Measuring resistance	35L
S25/20	Main battery switch	10H 24H
U2	MB interface	1G 64G
W5	Ground point (seat box)	33L
W29/3	Ground (left C-pillar)	8L 17L 21L 23L 36L 43L
W29/9	Ground (right D-pillar)	17L
X5.1	LHD auxiliary heater connector	28F
X5.2	LHD auxiliary heater metering pump connector	33F
X6	Auxiliary heater connector	27F
X58/30	Interior socket 110 V	54L
X58/31	Interior socket 110 V	57L
X58/32	Interior socket 110 V	59L
X156	Power outlet 110 V	52L
X310	Roof air conditioning control unit	62L

OV00.01-N-1901-03D	Use of wiring diagrams	MODEL XD1, XD2, XD3, XD4, XD5, XD6, XD7, YD1, YD2, YD3, YD4, YD5, YD6, YD7, WD1, WD2, WD3, WD6, WD7 MODEL 903.61 /66 /67, 904.61 /66 with CODE (ZU7) national version for Canada MODEL 903.61 /66 /67, 904.61 /66 with CODE (ZU8) national version for USA MODEL 903.61 /62 /66 /67, 904.61 /62 /66 with CODE (ZU9) national version for Mexico MODEL 903.662 with CODE (Z29) "James Cook" touring camper, NAFTA	
--------------------	------------------------	--	--

Wiring diagrams

The wiring diagrams are assigned to the known function groups 00-91. To make it easier to locate individual wiring diagrams, the systems are listed alphabetically with an indication of the function group/ function subgroup in the "Search aid through all wiring diagram groups (**A3**)".

The wiring diagrams are filed in the respective function group according to the PE number, e.g.: PE07.16-D-2000E

The wiring diagrams are compiled as system wiring diagrams and are structured as follows:

The representation of the system, e.g. ABS, contains all the electrical components up to the feed at the terminal blocks or fuses, respectively.

The wiring diagrams also contain linkages of possible versions and functions.

Linkages, recognizable as versions, may be framed and provided with an abbreviated designation/ abbreviation.

Explanations on identifications of variants with abbreviations such as KAWA can be found under "abbreviations" for workshop literature (**A4**)".

Cable cross-sections and cable colors may differ from that shown in the wiring diagrams.

Explanations:

Wiring diagram number e.g.: PE 07.16-D-2000-99E

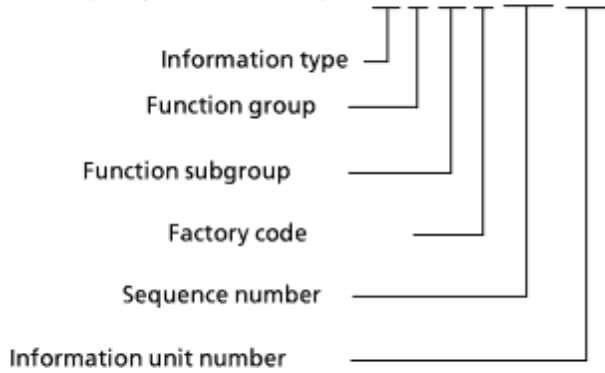

Wire designation e.g.: 1.5 gr/rt

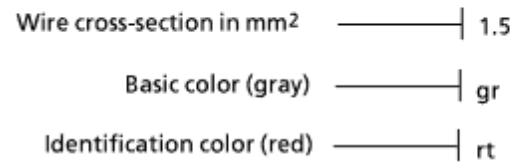

Connection designation e.g.:

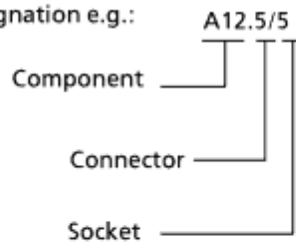

The symbol  PE . . refers to further wiring diagrams.

MODEL XD1, XD2, XD3, XD4, XD5, XD6, XD7, YD1, YD2, YD3, YD4, YD5, YD6, YD7, WD1, WD2, WD3, WD6, WD7

MODEL 903.61 /66 /67, 904.61 /66 with CODE (ZU7) National version for Canada

MODEL 903.61 /66 /67, 904.61 /66 with CODE (ZU8) National version for USA

MODEL 903.61 /62 /66 /67, 904.61 /62 /66 with CODE (ZU9) National version for Mexico

MODEL 903.662 with CODE (Z29) "James Cook" touring camper, NAFTA

	Designation	Notes	Wiring diagram
PE91.00-D-2000D	Airbag (AB), emergency tensioning retractor (ETR)	<p>MODEL XD1, XD2, XD3, XD4, XD5, XD6, XD7, YD1, YD2, YD3, YD4, YD5, YD6, YD7, WD1, WD2, WD3, WD6, WD7</p> <p>MODEL 903.61 /66 /67, 904.61 /66</p> <p>with CODE (SA5) Driver airbag with CODE (SA6) front passenger airbag with CODE (ZU7) national version for Canada</p> <p>MODEL 903.61 /66 /67, 904.61 /66</p> <p>with CODE (SA5) Driver airbag with CODE (SA6) front passenger airbag with CODE (ZU8) national version for USA</p> <p>MODEL 903.61 /62 /66 /67, 904.61 /62 /66</p> <p>with CODE (SA5) Driver airbag with CODE (SA6) front passenger airbag with CODE (ZU9) national version for Mexico</p>	PE91.00-D-2000D
PE31.19-D-2000G	Trailer hitch	<p>MODEL XD1##, XD2##, XD3##, XD4##, XD5##, XD6##, XD7##, YD1##, YD2##, YD3##, YD4##, YD5##, YD6##, YD7##, WD1##, WD2##, WD3##, WD6##, WD7## ### up to 649051 up to 31.3.04</p> <p>MODEL 903.61# /66# /67#,</p>	PE31.19-D-2000G

		<p>904.61# /66# ## up to 649051 up to 31.3.04 with CODE (E58) electrical system for trailer socket with CODE (ZU7) national version for Canada MODEL 903.61# /66# /67#, 904.61# /66# ## up to 649051 up to 31.3.04 with CODE (E58) electrical system for trailer socket with CODE (ZU8) national version for USA MODEL 903.61# /62# /66# /67#, 904.61# /62# /66# ## up to 649051 up to 31.3.04 with CODE (E58) electrical system for trailer socket with CODE (ZU9) national version for Mexico</p>	
PE31.19-D-2000H	Trailer hitch	<p>MODEL XD1##, XD2##, XD3##, XD4##, XD5##, XD6##, XD7##, YD1##, YD2##, YD3##, YD4##, YD5##, YD6##, YD7##, WD1##, WD2##, WD3##, WD6##, WD7## ### as of 649052 as of 1.4.04 MODEL 903.61# /66# /67#, 904.61# /66# ## as of 649052 as of 1.4.04 with CODE (E58) electrical system for trailer socket with CODE (ZU7) national version for Canada MODEL 903.61# /66# /67#, 904.61# /66# ## as of 649052 as of 1.4.04 with CODE (E58) electrical system for trailer socket with CODE (ZU8) national version for USA MODEL 903.61# /62# /66# /67#, 904.61# /62# /66# ## as of 649052 as of 1.4.04 with CODE (E58) electrical system for trailer socket with CODE (ZU9) national version for Mexico</p>	PE31.19-D-2000H
PE42.30-D-2200B	Anti-lock brake system (ABS)/acceleration slip	<p>MODEL XD1, XD2, XD3, XD6, XD7, YD1, YD2, YD3, YD6, YD7,</p>	PE42.30-D-2200B

	regulation (ASR)	WD1, WD2, WD3, WD6,WD7 MODEL 903.61 /66 /67 with CODE (BB0) brake system, ABS antilock brake system with CODE (ZU7) national version for Canada MODEL 903.61 /66 /67 with CODE (BB0) brake system, ABS antilock brake system with CODE (ZU8) national version for USA MODEL MODEL 903.61 62 /66 /67 with CODE (BB0) Brake system, antilock brake system ABS with CODE (ZU9) National version for Mexico	
PE42.30-D-2200C	Anti-lock brake system (ABS)/acceleration slip regulation (ASR)	MODEL XD4, XD5, YD4, YD5 MODEL /904.61 /66 with CODE (BB0) brake system, ABS antilock brake system with CODE (ZU7) national version for Canada MODEL /904.61 /66 with CODE (BB0) brake system, ABS antilock brake system with CODE (ZU8) national version for USA MODEL MODEL 903.61 62 /62 /66 with CODE (BB0) Brake system, antilock brake system ABS with CODE (ZU9) National version for Mexico	PE42.30-D-2200C
PE27.45-D-2000A	Working speed control (ADR)	Transmission 722.681 in MODELS XD1, XD2, XD3, XD4, XD5, XD6, XD7, YD1, YD2, YD3, YD4, YD5, YD6, YD7, WD1, WD2, WD3, WD6, WD7 with CODE (G40) Automatic transmission with CODE (M54) rpm increase with constant speed control Transmission 722.681 MODEL 903.61 /66 /67, 904.61 /66 with CODE (G40) Automatic transmission with CODE (M54) rpm increase with constant speed control with CODE (ZU7) National	PE27.45-D-2000A

		<p>version for Canada Transmission 722.681 in MODELS 903.61 /66 /67, 904.61 /66 with CODE (G40) Automatic transmission with CODE (M54) rpm increase with constant speed control with CODE (ZU8) national version for USA</p>	
PE82.10-D-2000E	Exterior lights	<p>MODEL XD1, XD2, XD3, XD4, XD5, XD6, XD7, YD1, YD2, YD3, YD4, YD5, YD6, YD7, WD1, WD2, WD3, WD6, WD7 MODEL 903.61 /66 /67, 904.61 /66 with CODE (ZU7) national version for Canada MODEL 903.61 /66 /67, 904.61 /66 with CODE (ZU8) national version for USA MODEL 903.61 /62 /66 /67, 904.61 /62 /66 with CODE (ZU9) national version for Mexico</p>	PE82.10-D-2000E
PE88.79-D-2000F	Exterior rearview mirrors	<p>MODEL XD1, XD2, XD3, XD4, XD5, XD6, XD7, YD1, YD2, YD3, YD4, YD5, YD6, YD7, WD1, WD2, WD3, WD6, WD7 MODEL 903.61 /66 /67, 904.61 /66 with CODE (F68) exterior rearview mirror, heated+electrically adjustable left and right with CODE (ZU7) national version for Canada MODEL 903.61 /66 /67, 904.61 /66 with CODE (F68) exterior rearview mirror, heated+electrically adjustable left and right with CODE (ZU8) national version for USA MODEL 903.61 /62 /66 /67, 904.61 /62 /66 with CODE (F68) exterior rearview mirror,</p>	PE88.79-D-2000F

		heated+electrically adjustable left and right with CODE (ZU9) national version for Mexico	
PE67.29-D-2000E	Heated rear window	MODEL YD1##, YD2##, YD3##, YD4##, YD5##, YD6##, YD7##, WD1##, WD2##, WD3##, WD6##, WD7## ### up to 605787 up to 28.11.03 MODEL 903.66# /67#, 904.66# ## up to 605787 up to 28.11.03 with CODE (H22) Heated rear window with CODE (ZU7) national version for Canada MODEL 903.66# /67#, 904.66# ## up to 605787 up to 28.11.03 with CODE (H22) Heated rear window with CODE (ZU8) national version for USA MODEL 903.66# /67#, 904.66# ## up to 605787 up to 28.11.03 with CODE (H22) Heated rear window with CODE (ZU9) national version for Mexico	PE67.29-D-2000E
PE67.29-D-2000F	Heated rear window	MODEL YD1##, YD2##, YD3##, YD4##, YD5##, YD6##, YD7##, WD1##, WD2##, WD3##, WD6##, WD7## ### up to 605787 up to 28.11.03 MODEL 903.66# /67#, 904.66# ## up to 605787 up to 28.11.03 with CODE (FY1) Breaking and entering- /anti-theft alarm system with interior protection, towing sensor and battery-operated horn with CODE (H22) heated rear window with CODE (ZU7) national version for Canada MODEL 903.66# /67#, 904.66# ## up to 605787 up to 28.11.03 with CODE (FY1) Breaking and entering- /anti-theft alarm system with interior protection, towing sensor and battery-operated horn	PE67.29-D-2000F

		with CODE (H22) heated rear window with CODE (ZU8) national version for USA	
PE67.29-D-2000G	Heated rear window	MODEL YD1##, YD2##, YD3##, YD4##, YD5##, YD6##, YD7##, WD1##, WD2##, WD3##, WD6##, WD7## ### as of 605788 as of 1.12.03 MODEL 903.66# /67#, 904.66## as of 605788 as of 1.12.03 with CODE (H22) Heated rear window with CODE (ZU7) national version for Canada MODEL 903.66# /67#, 904.66## as of 605788 as of 1.12.03 with CODE (H22) Heated rear window with CODE (ZU8) national version for USA MODEL 903.66# /67#, 904.66## as of 605788 as of 1.12.03 with CODE (H22) Heated rear window with CODE (ZU9) national version for Mexico	PE67.29-D-2000G
PE67.29-D-2000H	Heated rear window	MODEL YD1##, YD2##, YD3##, YD4##, YD5##, YD6##, YD7##, WD1##, WD2##, WD3##, WD6##, WD7## ### as of 605788 as of 1.12.03 MODEL 903.66# /67#, 904.66## as of 605788 as of 1.12.03 with CODE (FZ4) Breaking and entering- /anti-theft alarm system with interior protection and towing sensor with CODE (H22) heated rear window with CODE (ZU7) national version for Canada MODEL 903.66# /67#, 904.66## as of 605788 as of 1.12.03 with CODE (FZ4) breaking and entering- /anti-theft alarm system with interior protection and towing sensor with CODE (H22) heated rear window	PE67.29-D-2000H

		with CODE (ZU8) national version for USA	
PE82.10-D-2300B	Stop lamp	<p>MODEL YD1, YD2, YD3, YD4, YD5, YD6, YD7, WD1, WD2, WD3, WD6, WD7</p> <p>MODEL 903.61 /66 /67, 904.61 /66</p> <p>with CODE (LB5) Center high-mounted stop lamp</p> <p>with CODE (ZU7) national version for Canada</p> <p>MODEL 903.61 /66 /67, 904.61 /66</p> <p>with CODE (LB5) Center high-mounted stop lamp</p> <p>with CODE (ZU8) national version for USA</p> <p>MODEL 903.61 /66 /67, 904.61 /66</p> <p>with CODE (LB5) Center high-mounted stop lamp</p> <p>with CODE (ZU9) national version for Mexico</p>	PE82.10-D-2300B
PE00.19-D-2200D	Engine CAN bus	<p>MODEL XD1##, XD2##, XD3##, XD4##, XD5##, XD6##, XD7##, YD1##, YD2##, YD3##, YD4##, YD5##, YD6##, YD7##, WD1##, WD2##, WD3##, WD6##, WD7## ### up to 529900 up to 30.4.03</p> <p>MODEL 903.61# /66# /67#, 904.61# /66# ## up to 529900 up to 30.4.03</p> <p>with CODE (ZU7) national version for Canada</p> <p>MODEL 903.61# /66# /67#, 904.61# /66# ## up to 529900 up to 30.4.03</p> <p>with CODE (ZU8) national version for USA</p> <p>MODEL 903.61# /62# /66# /67#, 904.61# /62# /66# ## up to 529900 up to 30.4.03</p> <p>with CODE (ZU9) national version for Mexico</p>	PE00.19-D-2200D
PE00.19-D-2200E	Engine CAN bus	<p>MODEL XD1##, XD2##, XD3##, XD4##, XD5##, XD6##, XD7##, YD1##, YD2##, YD3##, YD4##, YD5##, YD6##, YD7##, WD1##,</p>	PE00.19-D-2200E

		<p>WD2##, WD3##, WD6##, WD7## ### as of 529901 as of 5.5.03 MODEL 903.61# /66# /67#, 904.61# /66# ## as of 529901 as of 5.5.03 with CODE (ZU7) national version for Canada MODEL 903.61# /66# /67#, 904.61# /66# ## as of 529901 as of 5.5.03 with CODE (ZU8) national version for USA MODEL 903.61# /62# /66# /67#, 904.61# /62# /66# ## as of 529901 as of 5.5.03 with CODE (ZU9) national version for Mexico</p>	
PE07.16-D-2000E	Common rail diesel injection (CDI)	<p>ENGINE 612.981 in MODEL XD1, XD2, XD3, XD4, XD5, XD6, XD7, YD1, YD2, YD3, YD4, YD5, YD6, YD7, WD1, WD2, WD3, WD6, WD7 ENGINE 612.981 in MODEL 903.61 /66 /67, 904.61 /66 with CODE (ZU7) national version for Canada ENGINE 612.981 in MODELS 903.61 /66 /67, 904.61 /66 with CODE (ZU8) national version for USA ENGINE 612.981 in MODEL 903.61 /62 /66 /67, 904.61 /62 /66 with CODE (ZU9) national version for Mexico vehicle wiring harness</p>	PE07.16-D-2000E
PE07.16-D-2000F	Common rail diesel injection (CDI)	<p>ENGINE 612.981 in MODELS XD1, XD2, XD3, XD4, XD5, XD6, XD7, YD1, YD2, YD3, YD4, YD5, YD6, YD7, WD1, WD2, WD3, WD6, WD7, ENGINE 612.981 in MODEL 903.61 /66 /67, 904.61 /66 with CODE (ZU7) national version for Canada ENGINE 612.981 in MODELS 903.61 /66 /67, 904.61 /66 with CODE (ZU8) national version for USA</p>	PE07.16-D-2000F

		ENGINE 612.981 in MODELS 903.61 /62 /660 /67, 904.61 /62 /66 with CODE (ZU9) national version for Mexico Engine wiring harness	
PE07.16-D-2000G	Common rail diesel injection (CDI)	ENGINE 647.981 in MODELS XD1, XD2, XD3, XD4, XD5, XD6, XD7, YD1, YD2, YD3, YD4, YD5, YD6, YD7, WD1, WD2, WD3, WD6, WD7 ENGINE 647.981 in MODELS 903.61 /66 /67, 904.61 /66 with CODE (ZU7) national version for Canada ENGINE 647.981 in MODELS 903.61 /66 /67, 904.61 /66 with CODE (ZU8) national version for USA ENGINE 647.981 in MODELS 903.61 /62 /66 /67, 904.61 /62 /66 with CODE (ZU9) national version for Mexico Engine wiring harness	PE07.16-D-2000G
PE07.16-D-2000H	Common rail diesel injection (CDI)	ENGINE 647.981 in MODELS XD1, XD2, XD3, XD4, XD5, XD6, XD7, YD1, YD2, YD3, YD4, YD5, YD6, YD7, WD1, WD2, WD3, WD6, WD7 ENGINE 647.981 in MODEL 903.61 /66 /67, 904.61 /66 with CODE (ZU7) national version for Canada ENGINE 647.981 in MODELS 903.61 /66 /67, 904.61 /66 with CODE (ZU8) national version for USA ENGINE 647.981 in MODELS 903.61 /62 /66 /67, 904.61 /62 /66 with CODE (ZU9) national version for Mexico Vehicle wiring harness	PE07.16-D-2000H
PE83.10-D-2100B	Roof ventilator	MODEL YD1, YD2, YD3, YD4, YD5, YD6, YD7, WD1, WD2, WD3, WD6, WD7 MODEL 903.61 /66 /67, 904.61 /66	PE83.10-D-2100B

		<p>with CODE (H72) Electric roof ventilator with CODE (ZU7) national version for Canada MODEL 903.61 /66 /67, 904.61 /66 with CODE (H72) Electric roof ventilator with CODE (ZU8) national version for USA MODEL 903.61 /66 /67, 904.61 /66 with CODE (H72) Electric roof ventilator with CODE (ZU9) national version for Mexico</p>	
PE35.40-D-2000D	Rear axle differential lock mechanism	<p>Rear axle 741 in MODELS XD1, XD2, XD3, XD4, XD5, XD6, XD7, YD1, YD2, YD3, YD4, YD5, YD6, YD7, WD1, WD2, WD3, WD6, WD7 Rear axle 741 in MODELS 903.61 /66 /67, 904.61 /66 with CODE (A71) rear axle differential lock with CODE (ZU7) national version for Canada Rear axle 741 in MODELS 903.61 /66 /67, 904.61 /66 with CODE (A71) Rear axle differential lock with CODE (ZU8) national version for USA</p>	PE35.40-D-2000D
PE82.20-D-2100C	Entry/exit lamps	<p>MODEL XD1, XD2, XD3, XD4, XD5, XD6, XD7, YD1, YD2, YD3, YD4, YD5, YD6, YD7, WD1, WD2, WD3, WD6, WD7 MODEL 903.61 /66 /67, 904.61 /66 with CODE (LB9) exit illuminated with CODE (ZU7) national version for Canada MODEL 903.61 /66 /67, 904.61 /66 with CODE (LB9) exit illuminated with CODE (ZU8) national version for USA</p>	PE82.20-D-2100C
PE80.50-D-2000D	Anti-theft alarm system [ATA]	<p>MODEL XD1, XD2, XD3, XD4, XD5, XD6, XD7, YD1, YD2, YD3,</p>	PE80.50-D-2000D

		<p>YD4, YD5, YD6, YD7, WD1, WD2, WD3, WD6, WD7 MODEL 903.61 /66 /67, 904.61 /66 with CODE (FY1) breaking and entering- /anti-theft alarm system with interior protection, towing sensor and battery-operated horn with CODE (ZU7) national version for Canada MODEL 903.61 /66 /67, 904.61 /66 with CODE (FY1) breaking and entering- /anti-theft alarm system with interior protection, towing sensor and battery-operated horn with CODE (ZU8) national version for USA</p>	
PE27.19-D-2100A	Electronic transmission control (ETC [EGS])	<p>Transmission 722.681 in MODELS XD1, XD2, XD3, XD4, XD5, XD6, XD7, YD1, YD2, YD3, YD4, YD5, YD6, YD7, WD1, WD2, WD3, WD6, WD7 Transmission 722.681 in MODELS 903.61 /66 /67, 904.61 /66 with CODE (G40) Automatic transmission with CODE (ZU7) national version for Canada Transmission 722.681 in MODELS 903.61 /66 /67, 904.61 /66 with CODE (G40) Automatic transmission with CODE (ZU8) national version for USA Transmission 722.681 in MODELS 903.61 /62 /66 /67, 904.61 /62 /66 with CODE (G40) Automatic transmission with CODE (ZU9) national version for Mexico</p>	PE27.19-D-2100A
PE42.45-D-2200B	Electronic stability program (ESP)	<p>MODEL XD1, XD2, XD3, XD6, XD7, YD1, YD2, YD3, YD6, YD7, WD1, WD2, WD3, WD6,WD7 MODEL 903.61 /66 /67</p>	PE42.45-D-2200B

		<p>with CODE (BB3) Electronic Stability Program with CODE (ZU7) national version for Canada MODEL 903.61 /66 /67 with CODE (BB3) Electronic Stability Program with CODE (ZU8) national version for USA</p>	
PE72.29-D-2001D	Power window	<p>MODEL XD1, XD2, XD3, XD4, XD5, XD6, XD7, YD1, YD2, YD3, YD4, YD5, YD6, YD7, WD1, WD2, WD3, WD6, WD7 MODEL 903.61 /66 /67, 904.61 /66 with CODE (V50) Power windows (2 doors) with CODE (ZU7) national version for Canada MODEL 903.61 /66 /67, 904.61 /66 with CODE (V50) Power windows (2 doors) with CODE (ZU8) national version for USA MODEL MODEL 903.61 /62 /66 /67, 904.61 /62 /66 with CODE (V50) Power window (2 doors) with CODE (ZU9) National version for Mexico</p>	PE72.29-D-2001D
PE80.35-D-2200C	Radio remote control with immobilizer and transponder	<p>MODEL XD1, XD2, XD3, XD4, XD5, XD6, XD7, YD1, YD2, YD3, YD4, YD5, YD6, YD7, WD1, WD2, WD3, WD6, WD7 MODEL 903.61 /66 /67, 904.61 /66 with CODE (ZU7) national version for Canada MODEL 903.61 /66 /67, 904.61 /66 with CODE (ZU8) national version for USA MODEL 903.61 /62 /66 /67, 904.61 /62 /66 with CODE (ZU9) national version for Mexico</p>	PE80.35-D-2200C
PE54.30-D-2001G	Instrument cluster	<p>Model XD1, XD2, XD3, XD4, XD5, XD6, XD7, YD1, YD2, YD3,</p>	PE54.30-D-2001G

		<p>YD4, YD5, YD6, YD7, WD1, WD2, WD3, WD6, WD7 MODEL 903.61 /66 /67, 904.61 /66 with CODE (J65) outside temperature indicator with CODE (ZU7) national version for Canada MODEL 903.61 /66 /67, 904.61 /66 with CODE (J65) outside temperature indicator with CODE (ZU8) national version for USA MODEL 903.61 /62 /66 /67, 904.61 /62 /66 with CODE (J65) outside temperature indicator with CODE (ZU9) national version for Mexico</p>	
PE83.20-D-2000E	Heater	<p>MODEL YD1, YD2, YD3, YD4, YD5 ## up to 365850 up to 18.1.02, WD1, WD2, WD3 ### up to 365850 up to 18.1.02 MODEL 903.66# /67#, 904.66# ## up to 365850 up to 18.1.02 with CODE (ZU8) national version for USA</p>	PE83.20-D-2000E
PE83.20-D-2000F	Heater	<p>MODEL YD1, YD2, YD3, YD4, YD5 ## up to 365850 up to 18.1.02, WD1, WD2, WD3 ### up to 365850 up to 18.1.02 MODEL 903.66# /67#, 904.66# ## up to 365850 up to 18.1.02 with CODE (H25) "Heizmatic" automatic heater control with CODE (ZU8) national version for USA</p>	PE83.20-D-2000F
PE83.20-D-2000G	Heater	<p>MODEL XD1, XD2, XD3, XD4, XD5, XD6, XD7, YD1, YD2, YD3, YD4, YD5, YD6, YD7 ## as of 365851 as of 21.1.02, WD1, WD2, WD3, WD6, WD7 ### as of 365851 as of 21.1.02 MODEL 903.61 /66 /67, 904.61 /66</p>	PE83.20-D-2000G

		<p>with CODE (ZU7) national version for Canada MODEL 903.61# /66# /67#, 904.61# /66# ## as of 365851 as of 21.1.02</p> <p>with CODE (ZU8) national version for USA MODEL 903.61 /62/66 /67, 904.61 /62/66</p> <p>with CODE (ZU9) national version for Mexico</p>	
PE83.20-D-2000H	Heater	<p>MODEL XD1, XD2, XD3, XD4, XD5, XD6, XD7, YD1##, YD2##, YD3##, YD4##, YD5##, YD6##, YD7##, WD1##, WD2##, WD3##, WD6##, WD7## ### as of 365851 as of 21.1.02</p> <p>MODEL 903.61 /66 /67, 904.61 /66</p> <p>with CODE (ZU7) national version for Canada MODEL 903.61# /66# /67#, 904.61# /66# ## as of 365851 as of 21.1.02</p> <p>with CODE (ZU8) national version for USA MODEL 903.61 /62 /66 /67, 904.61 /62 /66</p> <p>with CODE (ZU9) national version for Mexico</p>	PE83.20-D-2000H
PE82.20-D-2000L	Interior lights	<p>MODEL XD1, XD2, XD3, XD4, XD5, XD6, XD7, YD1, YD2, YD3, YD4, YD5, YD6, YD7, WD1, WD2, WD3, WD6, WD7</p> <p>MODEL 903.61 /66 /67, 904.61 /66</p> <p>with CODE (ZU7) national version for Canada MODEL 903.61 /66 /67, 904.61 /66</p> <p>with CODE (ZU8) national version for USA MODEL 903.61 /62 /66 /67, 904.61 /62 /66</p> <p>with CODE (ZU9) national version for Mexico</p>	PE82.20-D-2000L
PE82.20-D-2000M	Interior lights	<p>MODEL YD1##, YD2##, YD3##, YD4##, YD5##, YD6##, YD7##,</p>	PE82.20-D-2000M

		<p>WD1##, WD2##, WD3##, WD6##, WD7## ### up to 605787 up to 28.11.03 MODEL 903.61# /66# /67#, 904.61# /66# ## up to 605787 up to 28.11.03 with CODE (L63) Load compartment dome lamp with CODE (ZU7) national version for Canada MODEL 903.61# /66# /67#, 904.61# /66# ## up to 605787 up to 28.11.03 with CODE (L63) dome lamp load compartment with CODE (ZU8) national version for USA MODEL 903.61# /66# /67#, 904.61# /66# ## up to 605787 up to 28.11.03 with CODE (L63) dome lamp load compartment with CODE (ZU9) national version for Mexico</p>	
PE82.20-D-2000N	Interior lights	<p>MODEL YD1##, YD2##, YD3##, YD4##, YD5##, YD6##, YD7##, WD1##, WD2##, WD3##, WD6##, WD7## ### as of 605788 as of 1.12.03 MODEL 903.61# /66# /67#, 904.61# /66# ## up to 605788 up to 1.12.03 with CODE (L63) Load compartment dome lamp with CODE (ZU7) national version for Canada MODEL 903.61# /66# /67#, 904.61# /66# ## up to 605788 up to 1.12.03 with CODE (L63) Load compartment dome lamp with CODE (ZU8) national version for USA MODEL 903.61# /66# /67#, 904.61# /66# ## as of 605788 as of 1.12.03 with CODE (L63) Load compartment dome lamp with CODE (ZU9) national version for Mexico</p>	PE82.20-D-2000N

PE83.30-D-2001B	Climate control	MODEL YD1##, YD2##, YD3##, YD4##, YD5##, WD1##, WD2##, WD3## ### up to 365850 up to 18.1.02 MODEL MODEL 903.66# /67#, 904.66# ## to 365850 up to 18.1.02 with CODE (HH9) "Tempmatik" regulated air conditioning with CODE (ZU8) national version for USA	PE83.30-D-2001B
PE83.30-D-2001C	Climate control	MODEL WD1, WD2, WD3, WD6, WD7 MODEL MODELS 903.67 with CODE (HH7) Additional air conditioning in the rear with CODE (ZU8) National version for USA	PE83.30-D-2001C
PE83.30-D-2001E	Climate control	MODEL XD1, XD2, XD3, XD4, XD5, XD6, XD7, YD1##, YD2##, YD3##, YD4##, YD5##, YD6##, YD7##, WD1##, WD2##, WD3##, WD6##, WD7## ### as of 365851 as of 21.1.02 MODEL MODELS 903.61 /66 /67, 904.61 /66 with CODE (HH9) "Tempmatik" regulated air conditioning with CODE (ZU7) National version for Canada MODEL MODEL 903.61# /66# /67#, 904.61# /66# ## from 365851 as of 21.1.02 with CODE (HH9) "Tempmatik" regulated air conditioning with CODE (ZU8) national version for USA MODEL MODELS 903.61 /62 /66 /67, 904.61 /62 /66 with CODE (HH9) Regulated air conditioning, "Tempmatik" with CODE (ZU9) National version for Mexico	PE83.30-D-2001E
PE83.30-D-2001H	Climate control	MODEL YD1, YD2, YD3, YD4, YD5, YD6, YD7, WD1, WD2, WD3, WD6, WD7 MODEL 903.66 /67, 904.66 with CODE (H08) high-	PE83.30-D-2001H

		<p>performance air conditioning with CODE (ZU7) national version for Canada MODEL 903.66 /67, 904.66 with CODE (H08) high-performance air conditioning with CODE (ZU8) national version for USA MODEL 903.66 /67, 904.66 with CODE (H08) high-performance air conditioning with CODE (ZU9) national version for Mexico</p>	
PE54.25-D-2200C	Combination switch at electrical center, interior circuit	<p>MODEL XD1, XD2, XD3, XD4, XD5, XD6, XD7, YD1, YD2, YD3, YD4, YD5, YD6, YD7, WD1, WD2, WD3, WD6, WD7 MODEL 903.61 /66 /67, 904.61 /66 with CODE (ZU7) national version for Canada MODEL 903.61 /66 /67, 904.61 /66 with CODE (ZU8) national version for USA MODEL 903.61 /62 /66 /67, 904.61 /62 /66 with CODE (ZU9) national version for Mexico</p>	PE54.25-D-2200C
PE82.10-D-2501A	Front fog lamp	<p>MODEL XD1, XD2, XD3, XD4, XD5, XD6, XD7, YD1, YD2, YD3, YD4, YD5, YD6, YD7, WD1, WD2, WD3, WD6, WD7 MODEL 903.61 /66 /67, 904.61 /66 with CODE (L16) Halogen front fog lamp with CODE (ZU7) national version for Canada MODEL 903.61 /66 /67, 904.61 /66 with CODE (L16) Halogen front fog lamp with CODE (ZU8) national version for USA MODEL 903.61 /62 /66 /67, 904.61 /62 /66 with CODE (L16) Halogen front fog lamp with CODE (ZU9) national</p>	PE82.10-D-2501A

		version for Mexico	
PE54.22-D-2000E	Diagnosis/diagnostic socket data link connector	<p>MODEL XD1, XD2, XD3, XD4, XD5, XD6, XD7, YD1, YD2, YD3, YD4, YD5, YD6, YD7, WD1, WD2, WD3, WD6, WD7</p> <p>MODEL 903.61 /66 /67, 904.61 /66</p> <p>with CODE (ZU7) national version for Canada</p> <p>MODEL 903.61 /66 /67, 904.61 /66</p> <p>with CODE (ZU8) national version for USA</p> <p>MODEL 903.61 /62 /66 /67, 904.61 /62 /66</p> <p>with CODE (ZU9) national version for Mexico</p>	PE54.22-D-2000E
PE82.60-D-2000E	Radio	<p>MODEL XD1, XD2, XD3, XD4, XD5, XD6, XD7, YD1, YD2, YD3, YD4, YD5, YD6, YD7, WD1, WD2, WD3, WD6, WD7</p> <p>MODEL 903.61 /66 /67, 904.61 /66</p> <p>with CODE (E77) Additional stereo speaker</p> <p>with CODE (EF5) Sound 10 radio</p> <p>with CODE (EF7) Sound 30 radio</p> <p>with CODE (ZU7) national version for Canada</p> <p>MODEL 903.61 /66 /67, 904.61 /66</p> <p>with CODE (E77) Additional stereo speaker</p> <p>with CODE (EF5) Sound 10 radio</p> <p>with CODE (EF7) Sound 30 radio</p> <p>with CODE (ZU8) national version for USA</p> <p>MODEL 903.61 /62 /66 /67, 904.61 /62 /66</p> <p>with CODE (EF5) Sound 10 radio</p> <p>with CODE (ZU9) national version for Mexico</p>	PE82.60-D-2000E
PE82.10-D-2200D	Turn signal indicator lamps/hazard warning flasher	<p>MODEL XD1, XD2, XD3, XD4, XD5, XD6, XD7, YD1, YD2, YD3, YD4, YD5, YD6, YD7, WD1, WD2, WD3, WD6, WD7</p> <p>MODEL 903.61 /66 /67, 904.61 /66</p> <p>with CODE (ZU7) national</p>	PE82.10-D-2200D

		<p>version for Canada MODEL 903.61 /66 /67, 904.61 /66 with CODE (ZU8) national version for USA MODEL 903.61 /62 /66 /67, 904.61 /62 /66 with CODE (ZU9) national version for Mexico</p>	
PE82.30-D-2000D	Windshield wiper	<p>MODEL XD1, XD2, XD3, XD4, XD5, XD6, XD7, YD1, YD2, YD3, YD4, YD5, YD6, YD7, WD1, WD2, WD3, WD6, WD7 MODEL 903.61 /66 /67, 904.61 /66 with CODE (ZU7) national version for Canada MODEL 903.61 /66 /67, 904.61 /66 with CODE (ZU8) national version for USA MODEL 903.61 /62 /66 /67, 904.61 /62 /66 with CODE (ZU9) national version for Mexico</p>	PE82.30-D-2000D
PE82.30-D-2000F	Windshield wiper	<p>MODEL XD1, XD2, XD3, XD4, XD5, XD6, XD7, YD1, YD2, YD3, YD4, YD5, YD6, YD7, WD1, WD2, WD3, WD6, WD7 MODEL 903.61 /66 /67, 904.61 /66 with CODE (FM2) Tinted windshield, heated with rain sensor with CODE (ZU7) national version for Canada MODEL 903.61 /66 /67, 904.61 /66 with CODE (FM2) Tinted windshield, heated with rain sensor with CODE (ZU8) national version for USA MODEL 903.61 62 /66 /67, 904.61 62 /66 with CODE (FM2) Tinted windshield, heated with rain sensor with CODE (ZU9) national version for Mexico</p>	PE82.30-D-2000F

PE82.10-D-2400C	Side marking / Clearance lamps	<p>MODEL XD1, XD2, XD3, XD4, XD5, XD6, XD7, YD1, YD2, YD3, YD4, YD5, YD6, YD7, WD1, WD2, WD3, WD6, WD7</p> <p>MODEL 903.61 /66 /67, 904.61 /66</p> <p>with CODE (LB1) Side-marker lamps</p> <p>with CODE (ZU7) national version for Canada</p> <p>MODEL 903.61 /66 /67, 904.61 /66</p> <p>with CODE (LB1) Side-marker lamps</p> <p>with CODE (ZU8) national version for USA</p> <p>MODEL 903.61 /62 /66 /67, 904.61 /62 /66</p> <p>with CODE (LB1) Side-marker lamps</p> <p>with CODE (ZU9) national version for Mexico</p>	PE82.10-D-2400C
PE54.35-D-2000D	Signaling system	<p>MODEL XD1, XD2, XD3, XD4, XD5, XD6, XD7, YD1, YD2, YD3, YD4, YD5, YD6, YD7, WD1, WD2, WD3, WD6, WD7</p> <p>MODEL 903.61 /66 /67, 904.61 /66</p> <p>with CODE (ZU7) national version for Canada</p> <p>MODEL 903.61 /66 /67, 904.61 /66</p> <p>with CODE (ZU8) national version for USA</p> <p>MODEL 903.61 /62 /66 /67, 904.61 /62 /66</p> <p>with CODE (ZU9) national version for Mexico</p>	PE54.35-D-2000D
PE91.30-D-2000D	Heated seats (HS)	<p>MODEL XD1, XD2, XD3, XD4, XD5, XD6, XD7, YD1, YD2, YD3, YD4, YD5, YD6, YD7, WD1, WD2, WD3, WD6, WD7</p> <p>MODEL 903.61 /66 /67, 904.61 /66</p> <p>with CODE (SA5) Driver airbag</p> <p>with CODE (SA6) front passenger airbag</p> <p>with CODE (ZU7) national version for Canada</p>	PE91.30-D-2000D

		<p>MODEL 903.61 /66 /67, 904.61 /66 with CODE (SA5) Driver airbag with CODE (SA6) front passenger airbag with CODE (ZU8) national version for USA MODEL 903.61 /62 /66 /67, 904.61 /62 /66 with CODE (SA5) Driver airbag with CODE (SA6) front passenger airbag with CODE (ZU9) national version for Mexico</p>	
PE15.00-D-2000R	Starter, generator	<p>ENGINE 612.981 in MODEL XD1, XD2, XD3, XD4, XD5, XD6, XD7, YD1, YD2, YD3, YD4, YD5, YD6, YD7, WD1, WD2, WD3, WD6, WD7 ENGINE 612.981 in MODEL 903.61 /66 /67, 904.61 /66 with CODE (ZU7) national version for Canada ENGINE 612.981 in MODELS 903.61 /66 /67, 904.61 /66 with CODE (ZU8) national version for USA ENGINE ENGINE 612.981 in MODELS 903.61 /62 /66 /67, 904.61 /62 /66 with CODE (ZU9) National version for Mexico</p>	PE15.00-D-2000R
PE15.00-D-2000S	Starter, generator	<p>ENGINE 612.981 in MODELS YD1, YD2, YD3, YD4, YD5 ## up to 313476 up to 31.8.01, WD1, WD2, WD3 ### up to 313476 up to 31.8.01 ENGINE 612.981 in MODELS 903.66# /67#, 904.66# ## up to 313476 up to 31.8.01 with CODE (E28) Additional 12V/88 AH battery with CODE (E36) cutoff relay with CODE (ZU8) national version for USA</p>	PE15.00-D-2000S
PE15.00-D-2000T	Starter, generator	<p>ENGINE 612.981 in MODELS YD1##, YD2##, YD3##, YD4##, YD5##, WD1##, WD2##, WD3## ### up to 313476 up to 31.8.01</p>	PE15.00-D-2000T

		ENGINE ENGINE 612.981 in MODEL 903.66# /67#, 904.66# ## up to 313476 up to 31.8.01 with CODE (E28) Additional 12V/88 AH battery with CODE (E36) Isolating relay with CODE (M35) 14 V / 115 A alternator with CODE (ZU8) National version for USA	
PE15.00-D-2000U	Starter, generator	ENGINE 612.981 in MODEL XD1, XD2, XD3, XD4, XD5, XD6, XD7, YD1##, YD2##, YD3##, YD4##, YD5##, YD6##, YD7##, WD1##, WD2##, WD3##, WD6##, WD7## ### as of 313477 as of 3.9.01 ENGINE ENGINE 612.981 in MODEL 903.61 /66 /67, 904.61 /66 with CODE (E28) Additional 12V/88 AH battery with CODE (E36) Separating relay with CODE (ZU7) National version for Canada ENGINE 612.981 in MODELS 903.61# /66# /67#, 904.61# /66# ## as of 313477 as of 3.9.01 with CODE (E28) Additional 12V/88 AH battery with CODE (E36) cutoff relay with CODE (ZU8) national version for USA ENGINE 612.981 in MODELS 903.61 /62 /66 /67, 904.61 /62 /66 with CODE (E28) Additional 12V/88 AH battery with CODE (E36) cutoff relay with CODE (ZU9) national version for Mexico	PE15.00-D-2000U
PE15.00-D-2000W	Starter, generator	ENGINE 647.981 in MODELS XD1, XD2, XD3, XD4, XD5, XD6, XD7, YD1, YD2, YD3, YD4, YD5, YD6, YD7, WD1, WD2, WD3, WD6, WD7 ENGINE 647.981 in MODELS 903.61 /66 /67, 904.61 /66	PE15.00-D-2000W

		<p>with CODE (ZU7) national version for Canada ENGINE 647.981 in MODELS 903.61 /66 /67, 904.61 /66</p> <p>with CODE (ZU8) national version for USA ENGINE 647.981 in MODELS 903.61 /62 /66 /67, 904.61 /62 /66</p> <p>with CODE (ZU9) national version for Mexico</p>	
PE82.00-D-2500C	Interior socket	<p>MODEL XD1, XD2, XD3, XD4, XD5, XD6, XD7, YD1, YD2, YD3, YD4, YD5, YD6, YD7, WD1, WD2, WD3, WD6, WD7</p> <p>MODEL MODEL 903.61 /66, 67 with CODE (EK1) Terminal strip for electrical connection at driver seat frame</p> <p>with CODE (ES5) 12V socket in instrument panel</p> <p>with CODE (ZU7) national version for Canada</p> <p>MODEL MODEL 903.61 /66, 67 with CODE (EK1) Terminal strip for electrical connection at driver seat frame</p> <p>with CODE (ES5) 12V socket in instrument panel</p> <p>with CODE (ZU8) national version for Canada</p> <p>MODEL MODEL 903.61 /62 /66 67, 904.61 62 /66</p> <p>with CODE (EK1) Terminal strip for electrical connection to driver seat frame</p> <p>with CODE (ES5) 12V socket in instrument panel</p> <p>with CODE (ZU9) Mexico national version</p>	PE82.00-D-2500C
PE82.10-D-2100F	Daytime running lamps	<p>MODEL XD1, XD2, XD3, XD4, XD5, XD6, XD7, YD1, YD2, YD3, YD4, YD5, YD6, YD7, WD1, WD2, WD3, WD6, WD7</p> <p>MODEL 903.61 /66 /67, 904.61 /66</p> <p>with CODE (L05) automatic daytime running lamps</p> <p>with CODE (ZU7) national version for Canada</p>	PE82.10-D-2100F

		<p>MODEL 903.61 /66 /67, 904.61 /66 with CODE (L05) automatic daytime running lamps with CODE (ZU8) national version for USA</p>	
PE82.70-D-2000D	Telephone (TEL)	<p>MODEL XD1, XD2, XD3, XD4, XD5, XD6, XD7, YD1, YD2, YD3, YD4, YD5, YD6, YD7, WD1, WD2, WD3, WD6, WD7 MODEL 903.61 /66 /67, 904.61 /66 with CODE (JV4) portable CTEL telephone preinstallation with CODE (EV7) preinstallation for hands-free system with CODE (ZU7) national version for Canada MODEL 903.61 /66 /67, 904.61 /66 with CODE (JV4) portable CTEL telephone preinstallation with CODE (EV7) preinstallation for hands-free system with CODE (ZU8) national version for USA</p>	PE82.70-D-2000D
PE68.00-D-2000D	Mobile caravan	<p>MODEL 903.662 with CODE (Z29) "James Cook" touring camper, NAFTA sheet 1</p>	PE68.00-D-2000D
PE68.00-D-2000E	Mobile caravan	<p>MODEL 903.662 with CODE (Z29) "James Cook" touring camper, NAFTA sheet 2</p>	PE68.00-D-2000E
PE80.20-D-2000F	Central locking (CL [ZV])	<p>MODEL XD1, XD2, XD3, XD4, XD5, XD6, XD7, YD1, YD2, YD3, YD4, YD5, YD6, YD7, WD1, WD2, WD3, WD6, WD7 MODEL 903.61 /66 /67, 904.61 /66 with CODE (FY6) Central locking with radio remote control with CODE (ZU7) national version for Canada MODEL 903.61 /66 /67, 904.61 /66 with CODE (FY6) Central locking with radio remote control with CODE (ZU8) national</p>	PE80.20-D-2000F

		<p>version for USA MODEL 903.61 /62 /66 /67, 904.61 /62 /66 with CODE (FY6) Central locking with radio remote control with CODE (ZU9) national version for Mexico</p>	
PE83.70-D-2001LA	Auxiliary heater (ZHE)	<p>MODEL YD1, YD2, YD3, YD4, YD5, YD6, YD7 ## as of 382002 as of 12.3.02, WD1, WD2, WD3, WD6, WD7 ### as of 382002 as of 12.3.02 MODEL 903.66 /67, 904.66 with CODE (H11) Warm air auxiliary heater with CODE (ZU7) national version for Canada MODEL MODEL 903.66# /67#, 904.66# ## from 382002 as of 12.3.02 with CODE (H11) Warm air auxiliary heater with CODE (ZU8) national version for USA Heater designation AIRTRONIC D4</p>	PE83.70-D-2001LA
PE83.70-D-2001S	Auxiliary heater (ZHE)	<p>MODEL YD1, YD2, YD3, YD4, YD5 ## up to 382001 up to 11.3.02, WD1, WD2, WD3 ### up to 382001 up to 11.3.02 MODEL 903.66# /67#, 904.66# ## up to 382001 up to 11.3.02 with CODE (H11) Warm air auxiliary heater with code (ZU8) national version for USA Heater designation D3L-C compact</p>	PE83.70-D-2001S
PE83.70-D-2001T	Auxiliary heater (ZHE)	<p>MODEL XD1, XD2, XD3, XD4, XD5, XD6, XD7, YD1, YD2, YD3, YD4, YD5, YD6, YD7, WD1, WD2, WD3, WD6, WD7 MODEL 903.61 /66 /67, 904.61 /66 with CODE (HZ9) Heater booster, diesel with CODE (ZU7) national</p>	PE83.70-D-2001T

		<p>version for Canada MODEL 903.61 /66 /67, 904.61 /66 with CODE (HZ9) Heater booster, diesel with CODE (ZU8) national version for USA</p>	
PE83.70-D-2001U	Auxiliary heater (ZHE)	<p>MODEL YD1, YD2, YD3, YD4, YD5, YD6, YD7, WD1, WD2, WD3, WD6, WD7 MODEL 903.66 /67, 904.66 with CODE (H13) additional heat exchanger in load compartment with CODE (ZU7) national version for Canada MODEL 903.66 /67, 904.66 with CODE (H13) additional heat exchanger in the load compartment with CODE (ZU8) national version for USA MODEL 903.66 /67, 904.66 with CODE (H13) additional heat exchanger in load compartment with CODE (ZU9) national version for Mexico</p>	PE83.70-D-2001U
PE83.70-D-2001V	Auxiliary heater (ZHE)	<p>MODEL XD1, XD2, XD3, XD4, XD5, XD6, XD7, YD1, YD2, YD3, YD4, YD5, YD6, YD7, WD1, WD2, WD3, WD6, WD7 MODEL 903.61 /66 /67, 904.61 /66 with CODE (H12) warm water auxiliary heater with CODE (H86) Timer for auxiliary heater with CODE (ZU7) national version for Canada MODEL 903.61 /66 /67, 904.61 /66 with CODE (H12) warm water auxiliary heater with CODE (H86) Timer for auxiliary heater with CODE (ZU8) national version for USA MODEL MODEL 903.61 /62/66 /67, 904.61 /62/66 with CODE (H12) Warm water</p>	PE83.70-D-2001V

		auxiliary heater with CODE (H86) Preselection timer for auxiliary heater with CODE (ZU9) national version for Mexico Heater designation D5WS	
--	--	---	--

OV00.01-N-1001-27E	Abbreviations for electrical wiring diagrams	<p>MODEL XD1, XD2, XD3, XD4, XD5, XD6, XD7, YD1, YD2, YD3, YD4, YD5, YD6, YD7, WD1, WD2, WD3, WD6, WD7</p> <p>MODEL 903.61 /66 /67, 904.61 /66 with CODE (ZU7) national version for Canada</p> <p>MODEL 903.61 /66 /67, 904.61 /66 with CODE (ZU8) national version for USA</p> <p>MODEL 903.61 /62 /66 /67, 904.61 /62 /66 with CODE (ZU9) national version for Mexico</p> <p>MODEL 903.662 with CODE (Z29) "James Cook" touring camper, NAFTA</p>	
--------------------	--	---	--

Abbreviation	Designation	Code	FG.FSG
AB	Airbag	CODE (SA5) Driver airbag CODE (SA6) Front passenger airbag	91.00
ABS	Antilock brake system	CODE (BB0) Brake system anti-lock brake system ABS	42.30
ASR	Acceleration slip regulation	CODE (BB0) Brake system anti-lock brake system ABS	42.30
BLL	Turn signal lamps		82.10
BLS	Wastrail wiring harness		
CAN	Controller Area Network (databus)		
CDI	Common rail diesel injection		07.16
DLS	Roof wiring harness		
ATA	Anti-theft alarm system	CODE (FY1) Anti-theft alarm with interior motion sensor, towing sensor and battery-operated horn	80.50
ETC	Electronic transmission control	CODE (G40) Automatic transmission	27.19
ESP	Electronic Stability Program	CODE (BB3) Electronic Stability Program	42.45
ESM	Electronic selector module	CODE (G40) Automatic transmission	27.19

FAB	Non-MB body	CODE (L72) Electrical system for non-MB bodies	82.10
GUS	Emergency tensioning retractor	CODE (SA5) Driver airbag	91.00
KAWA	Panel van		82.10
IC	Instrument cluster	CODE (J65) Ambient temperature display	54.30
KLR	Climate control	CODE (HH9) "Tempmatik" regulated air conditioning CODE (HH7) Additional air conditioning in the rear	83.30
KZL	License plate lights		82.10
MLS	Engine wiring harness		
RLS	Frame wiring harness		
HS	Heated seats	CODE (H15) Heater for front passenger seat CODE (H16) Heater for driver seat	91.30
SML	Side-marker lamps		82.10
SRS	Supplemental restraint systems	CODE (SA5) Driver airbag CODE (SA6) Front passenger airbag	91.00
TFL	Daytime running lamps	CODE (L05) Automatic daytime running lamps	82.10
TEL	Telephone	CODE (JV4) Preinstallation for portable CTEL	82.70
CC	Cruise control		07
URL	Clearance lamps		82.10
WSP	Immobilizer		80.35
ZHE	Auxiliary heater	CODE (HZ9) Heater booster, diesel CODE (H11) Warm air auxiliary heater CODE (H12) Warm water auxiliary heater CODE (H13) Additional heat exchanger in cargo area CODE (H86) Timer for auxiliary heater	83.70
CL	Central locking	CODE (FY6) Central locking with radio remote control	80.20

GF00.19-D-2000D	Arrangement and assignment of ground points	19.1.01
------------------------	--	----------------

MODELSXD1, XD2, XD3, XD4, XD5, XD6, XD7, YD1, YD2, YD3, YD4, YD5, YD6, YD7, WD1, WD2, WD3, WD6, WD7

MODELS903.61 /66 /67, 904.61 /66 with CODE (ZU7) National version for Canada

MODELS903.61 /66 /67, 904.61 /66 with CODE (ZU8) National version for USA

MODELS903.61 /62 /66 /67, 904.61 /62 /66 with CODE (ZU9) National version for Mexico

GF00.19-D-2000-07D	Arrangement and assignment of ground points	<p>Models XD1, XD2, XD3, XD4, XD5, XD6, XD7, YD1, YD2, YD3, YD4, YD5, YD6, YD7, WD1, WD2, WD3, WD6, WD7</p> <p>Models 903.61/66/67, 904.61/66 with code (ZU7) National version for Canada</p> <p>Models 903.61/66/67, 904.61/66 with code (ZU8) National version for USA</p> <p>Models 903.61/62/66/67, 904.61/62/66 with code (ZU9) National version for Mexico</p>	GF00.19-D-2000-07D
GF00.19-D-2000-08D	Assignment of ground points	<p>Models XD1, XD2, XD3, XD4, XD5, XD6, XD7, YD1, YD2, YD3, YD4, YD5, YD6, YD7, WD1, WD2, WD3, WD6, WD7</p> <p>Models 903.61/66/67, 904.61/66 with code (ZU7) National version for Canada</p> <p>Models 903.61/66/67, 904.61/66 with CODE (ZU8) National version for USA</p> <p>Models 903.61/62/66/67, 904.61/62/66 with code (ZU9) National version for Mexico</p>	GF00.19-D-2000-08D

PE15.00-D-1100D	Survey of wiring diagrams, electrical system, engine	6.3.01
------------------------	---	---------------

ENGINE612.981, 647.981 in MODEL XD1, XD2, XD3, XD4, XD5, XD6, XD7, YD1, YD2, YD3, YD4, YD5, YD6, YD7, WD1, WD2, WD3, WD6, WD7

ENGINE612.981, 647.981 in MODEL 903.61 /66 /67, 904.61 /66 with CODE (ZU7) National version for Canada

ENGINE612.981, 647.981 in MODEL 903.61 /66 /67, 904.61 /66 with CODE (ZU8) National version for USA

ENGINE612.981, 647.981 in MODEL 903.61 /62 /66 /67, 904.61 /62 /66 with CODE (ZU9) National version for Mexico

PE15.00-D-2000R	Wiring diagram starter, alternator	ENGINE 612.981 in MODEL XD1, XD2, XD3, XD4, XD5, XD6, XD7, YD1, YD2, YD3, YD4, YD5, YD6, YD7, WD1, WD2, WD3, WD6, WD7 ENGINE 612.981 in MODEL 903.61 /66 /67, 904.61 /66 with CODE (ZU7) National version Canada ENGINE 612.981 in MODEL 903.61 /66 /67, 904.61 /66 with CODE (ZU8) National version USA ENGINE 612.981 in MODEL 903.61 /62 /66 /67, 904.61 /62 /66 with CODE (ZU9) National version Mexico	PE15.00-D-2000R
PE15.00-D-2000S	Wiring diagram starter, alternator	ENGINE 612.981 in MODEL YD1##, YD2##, YD3##, YD4##, YD5##, WD1##, WD2##, WD3## ### up to 313476 up to 31.8.01 ENGINE 612.981 in MODEL 903.66# /67#, 904.66# ## up to 313476 up to 31.8.01 with CODE (E28) Additional battery 12V/88 AH with CODE (E36) Cutoff relay with CODE (ZU8) National version USA	PE15.00-D-2000S
PE15.00-D-2000T	Wiring diagram starter, alternator	ENGINE 612.981 in MODEL YD1##, YD2##, YD3##, YD4##, YD5##, WD1##, WD2##, WD3## ### up to 313476 up to 31.8.01 ENGINE 612.981 in MODEL 903.66# /67#, 904.66# ## up to	PE15.00-D-2000T

		<p>313476 up to 31.8.01 with CODE (E28) Additional battery 12V/88 AH with CODE (E36) Cutoff relay with CODE (M35) Alternator 14 V / 115 A with CODE (ZU8) National version USA</p>	
PE15.00-D-2000U	Wiring diagram starter, alternator	<p>ENGINE 612.981 in MODEL XD1, XD2, XD3, XD4, XD5, XD6, XD7, YD1##, YD2##, YD3##, YD4##, YD5##, YD6##, YD7##, WD1##, WD2##, WD3##, WD6##, WD7## ### as of 313477 as of 3.9.01 ENGINE 612.981 in MODEL 903.61 /66 /67, 904.61 /66 with CODE (E28) Additional battery 12V/88 AH with CODE (E36) Cutoff relay with CODE (ZU7) National version Canada ENGINE 612.981 in MODEL 903.61# /66/67#, 904.61# /66# ## as of 313477 as of 3.9.01 with CODE (E28) Additional battery 12V/88 AH with CODE (E36) Cutoff relay with CODE (ZU8) National version USA ENGINE 612.981 in MODEL 903.61 /62 /66 67, 904.61 /62 /66 with CODE (E28) Additional battery 12V/88 AH with CODE (E36) Cutoff relay with CODE (ZU9) National version Canada</p>	PE15.00-D-2000U
PE15.00-D-2000W	Wiring diagram starter, alternator	<p>ENGINE 647.981 in MODEL XD1, XD2, XD3, XD4, XD5, XD6, XD7, YD1, YD2, YD3, YD4, YD5, YD6, YD7, WD1, WD2, WD3, WD6, WD7 ENGINE 647.981 in MODEL 903.61 /66 /67, 904.61 /66 with CODE (ZU7) National version Canada ENGINE 647.981 in MODEL 903.61 /66 /67, 904.61 /66 with CODE (ZU8) National</p>	PE15.00-D-2000W

	version USA ENGINE 647.981 in MODEL 903.61 /62 /66 /67, 904.61 /62 /66 with CODE (ZU9) National version Mexico	
--	---	--

MODEL XD1, XD2, XD3, XD4, XD5, XD6, XD7, YD1, YD2, YD3, YD4, YD5, YD6, YD7, WD1, WD2, WD3, WD6, WD7

MODEL 903.61 /66 /67, 904.61 /66 with CODE (ZU7) National version for Canada

MODEL 903.61 /66 /67, 904.61 /66 with CODE (ZU8) National version for USA

MODEL 903.61 /62 /66 /67, 904.61 /62 /66 with CODE (ZU9) National version for Mexico

PE83.10-D-2100B	Wiring diagram roof fan	<p>MODEL YD1, YD2, YD3, YD4, YD5, YD6, YD7, WD1, WD2, WD3, WD6, WD7</p> <p>MODEL 903.61 /66 /67, 904.61 /66 with CODE (H72) Electric roof ventilator with CODE (ZU7) National version for Canada</p> <p>MODEL 903.61 /66 /67, 904.61 /66 with CODE (H72) Electric roof ventilator with CODE (ZU8) National version for USA</p> <p>MODEL 903.61 /66 /67, 904.61 /66 with CODE (H72) Electric roof ventilator with CODE (ZU9) National version for Mexico</p>	PE83.10-D-2100B
PE83.20-D-2000E	Wiring diagram heater	<p>MODEL YD1, YD2, YD3, YD4, YD5 ## up to 365850 up to 18.1.02, WD1, WD2, WD3 ### up to 365850 up to 18.1.02</p> <p>MODEL 903.66# /67#, 904.66# ## to 365850 up to 18.1.02 with CODE (ZU8) National version for USA</p>	PE83.20-D-2000E
PE83.20-D-2000F	Wiring diagram heater	<p>MODEL YD1, YD2, YD3, YD4, YD5 ## up to 365850 up to 18.1.02, WD1, WD2, WD3 ### up to 365850 up to 18.1.02</p> <p>MODEL 903.66# /67#, 904.66#</p>	PE83.20-D-2000F

		## to 365850 up to 18.1.02 with CODE (H25) "Heizmatic" automatic heater control with CODE (ZU8) National version for USA	
PE83.20-D-2000G	Wiring diagram heater	MODEL XD1, XD2, XD3, XD4, XD5, XD6, XD7, YD1, YD2, YD3, YD4, YD5, YD6, YD7 ## as from 365851 as from 21.1.02, WD1, WD2, WD3, WD6, WD7 ### as from 365851 as from 21.1.02 MODEL 903.61 /66 /67, 904.61 /66 with CODE (ZU7) National version for Canada MODEL 903.61# /66# /67#, 904.61# /66# ## from 365851 as of 21.1.02 with CODE (ZU8) National version for USA MODEL 903.61 /62 /66 /67, 904.61 /62 /66 with CODE (ZU9) National version for Mexico	PE83.20-D-2000G
PE83.20-D-2000H	Wiring diagram heater	MODEL XD1, XD2, XD3, XD4, XD5, XD6, XD7, YD1##, YD2##, YD3##, YD4##, YD5##, YD6##, YD7##, WD1##, WD2##, WD3##, WD6##, WD7## ### as from 365851 as from 21.1.02 MODEL 903.61 /66 /67, 904.61 /66 with CODE (ZU7) National version for Canada MODEL 903.61# /66# /67#, 904.61# /66# ## from 365851 as of 21.1.02 with CODE (ZU8) National version for USA MODEL 903.61 /62 /66 /67, 904.61 /62 /66 with CODE (ZU9) National version for Mexico	PE83.20-D-2000H
PE83.30-D-2001B	Wiring diagram of climate control	MODEL YD1##, YD2##, YD3##, YD4##, YD5##, WD1##, WD2##, WD3## ### up to 365850 up to	PE83.30-D-2001B

		18.1.02 MODEL 903.66# /67#, 904.66# ## up to 365850 up to 18.1.02 with CODE (HH9) "Tempmatic" regulated air conditioning with CODE (ZU8) National version for USA	
PE83.30-D-2001C	Wiring diagram of climate control	MODEL WD1, WD2, WD3, WD6, WD7 MODEL 903.67 with CODE (HH7) Air conditioning additionally in rear with CODE (ZU8) National version for USA	PE83.30-D-2001C
PE83.30-D-2001E	Wiring diagram of climate control	MODEL XD1, XD2, XD3, XD4, XD5, XD6, XD7, YD1##, YD2##, YD3##, YD4##, YD5##, YD6##, YD7##, WD1##, WD2##, WD3##, WD6##, WD7## ### as from 365851 as from 21.1.02 MODEL 903.61 /66 /67, 904.61 /66 with CODE (HH9) Regulated air conditioning,"Tempmatic" with CODE (ZU7) National version for Canada MODEL 903.61# /66# /67#, 904.61# /66# ## from 365851 as from 21.1.02 with CODE (HH9) "Tempmatic" regulated air conditioning with CODE (ZU8) National version for USA MODEL 903.61 /62 /66 /67, 904.61 /62 /66 with CODE (HH9) Tempmatic" regulated air conditioning with CODE (ZU9) National version for Mexico	PE83.30-D-2001E
PE83.30-D-2001H	Wiring diagram of climate control	MODEL YD1, YD2, YD3, YD4, YD5, YD6, YD7, WD1, WD2, WD3, WD6, WD7 MODEL 903.66 /67, 904.66 with CODE (H08) Heavy-duty air-conditioning system with CODE (ZU7) National version for Canada MODEL 903.66 /67, 904.66	PE83.30-D-2001H

		<p>with CODE (H08) Heavy-duty air-conditioning system with CODE (ZU8) National version for USA MODEL 903.66 /67, 904.66 with CODE (H08) Heavy-duty air-conditioning system with CODE (ZU9) National version for Mexico</p>	
PE83.70-D-2001LA	Wiring diagram of auxiliary heater (ZHE)	<p>MODEL YD1, YD2, YD3, YD4, YD5, YD6, YD7 ## as from 382002 as from 12.3.02, WD1, WD2, WD3, WD6, WD7 ### as from 382002 as from 12.3.02 MODEL 903.66 /67, 904.66 with CODE(H11) Warm air auxiliary heater with CODE (ZU7) National version for Canada MODEL 903.66# /67#, 904.66# ## as from 382002 as from 12.3.02 with CODE (H11) Warm air auxiliary heater with CODE (ZU8) National version for USA Heater designation AIRTRONIC D4</p>	PE83.70-D-2001LA
PE83.70-D-2001S	Wiring diagram of auxiliary heater (ZHE)	<p>MODEL YD1, YD2, YD3, YD4, YD5 ## up to 382001 up to 11.3.02, WD1, WD2, WD3 ### up to 382001 up to 11.3.02 MODEL 903.66# /67#, 904.66# ## up to 382001 up to 11.3.02 with CODE (H11) Warm air auxiliary heater with CODE (ZU8) National version for USA Heater designation D3L-C compact</p>	PE83.70-D-2001S
PE83.70-D-2001T	Wiring diagram of auxiliary heater (ZHE)	<p>MODEL XD1, XD2, XD3, XD4, XD5, XD6, XD7, YD1, YD2, YD3, YD4, YD5, YD6, YD7, WD1, WD2, WD3, WD6, WD7 MODEL 903.61 /66 /67, 904.61 /66</p>	PE83.70-D-2001T

		<p>with CODE (HZ9) Heater booster, diesel</p> <p>with CODE (ZU7) National version for Canada</p> <p>MODEL 903.61 /66 /67, 904.61 /66</p> <p>with CODE (HZ9) Heater booster, diesel</p> <p>with CODE (ZU8) National version for USA</p>	
PE83.70-D-2001U	Wiring diagram of auxiliary heater (ZHE)	<p>MODEL YD1, YD2, YD3, YD4, YD5, YD6, YD7, WD1, WD2, WD3, WD6, WD7</p> <p>MODEL 903.66 /67, 904.66</p> <p>with CODE (H13) Additional heat exchanger in load compartment</p> <p>with CODE (ZU7) National version for Canada</p> <p>MODEL 903.66 /67, 904.66</p> <p>with CODE (H13) Additional heat exchanger in load compartment</p> <p>with CODE (ZU8) National version for USA</p> <p>MODEL 903.66 /67, 904.66</p> <p>with CODE (H13) Additional heat exchanger in load compartment</p> <p>with CODE (ZU9) National version for Mexico</p>	PE83.70-D-2001U
PE83.70-D-2001V	Wiring diagram of auxiliary heater (ZHE)	<p>MODEL XD1, XD2, XD3, XD4, XD5, XD6, XD7, YD1, YD2, YD3, YD4, YD5, YD6, YD7, WD1, WD2, WD3, WD6, WD7</p> <p>MODEL 903.61 /66 /67, 904.61 /66</p> <p>with CODE (H12) Warm water auxiliary heater</p> <p>with CODE (H86) Timer for auxiliary heater</p> <p>with CODE (ZU7) National version for Canada</p> <p>MODEL 903.61 /66 /67, 904.61 /66</p> <p>with CODE (H12) Warm water auxiliary heater</p> <p>with CODE (H86) Timer for auxiliary heater</p> <p>with CODE (ZU8) National version for USA</p> <p>MODEL 903.61 /62/66 /67,</p>	PE83.70-D-2001V

		904.61 /62/66 with CODE (H12) Warm water auxiliary heater with CODE (H86) Timer for auxiliary heater with CODE (ZU9) National version for Mexico Heater designation D5WS	
--	--	---	--

PE68.00-D-2000-99E

[Display in a separate window](#)

To display wiring diagrams, you need a
JAVA 1.1 capable Browser like e.g. "Microsoft Internet Explorer 4.0"
or
"Netscape Navigator 4.05" and higher with AWT 1.1 support

A99	Hot water boiler
A100	Lavatory
A101	Tilting/sliding roof window
A102	Exhaust hood
B146/3	Black water fill level sensor
B146/4	Black water fill level indicator
E18/1	Luggage compartment lamp
E25/10	Roof fluorescent lamp, right
E25/11	Roof fluorescent lamp, left
E25/12	Washroom fluorescent lamp
E25/13	Kitchen halogen lamp, right
E25/14	Kitchen halogen lamp, left
E25/15	Roof halogen lamp, right
E25/16	Roof halogen lamp, left
E25/17	Side window fluorescent lamp
F72	12V fuse strip
F72	12V fuse strip
F72	12V fuse strip
F72	12V fuse strip
F72f2	Water pump, lavatory, illumination fuse
F72f2	Water pump, lavatory, illumination fuse
F72f3	Illumination, exhaust hood fuse
F72f5	Tilting/sliding roof window fuse
G1/1	Additional battery
G1/1	Additional battery

G1/1	Additional battery
G1/1	Additional battery
J1/1	Voltage supply cabinet connector sleeve
J2/1	Right D-pillar ground connector sleeve
J4/1	Roof illumination connector sleeve
M77/1	Fresh water pump
S25/20	Main battery switch
S25/20	Main battery switch
S25/20	Main battery switch
S25/20	Main battery switch
S190/1	Kitchen water tap switch
S190/2	Shower switch
S190/5	Roof halogen lamp switch
S190/7	Washroom fluorescent lamp switch
S190/8	Luggage compartment lamp door contact switch
S190/9	Kitchen halogen lamp switch
S190/10	Roof fluorescent lamp switch
S190/11	Water pump switch
S190/12	Shower switch, outside
S190/13	Town water switch
W29/3	Ground (left C-pillar)
W29/3	Ground (left C-pillar)

W29/9	Ground (right D-pillar)
W29/9	Ground (right D-pillar)
W48	Ground (left rear roof frame)
W48	Ground (left rear roof frame)
W48	Ground (left rear roof frame)
W48	Ground (left rear roof frame)
W48	Ground (left rear roof frame)
W48	Ground (left rear roof frame)
X7	Cab socket
X7/1	Roof stowage box connector
X7/2	Cabinet connector
X7/3	Lavatory connector
X7/4	Lavatory connector
X58/29	12V socket



PE68.00-D-2000-60E	Legend of wiring diagram for motor caravan	MODEL 903.662 with CODE (Z29) "James Cook" touring camper, NAFTA sheet 1	
--------------------	--	--	--

Code	Designation	Coordinates
A99	Hot water boiler	39L
A100	Toilet	56L
A101	Raising/tilting roof window	5L
A102	Range hood	29L
B146/3	Fill level sensor for faeces	46L
B146/4	Fill level display for faeces	49L
E18/1	Luggage compartment lamp	14L
E25/10	Right roof fluorescent lamp	7L
E25/11	Left roof fluorescent lamp	9L
E25/12	Washroom fluorescent lamp	37L
E25/13	Right kitchen halogen bulb	26L
E25/14	Left kitchen halogen bulb	25L
E25/15	Right roof halogen bulb	42L
E25/16	Left roof halogen bulb	44L
E25/17	Side window halogen lamp	17L
F72	12 V fuse strip	1F 18F 31F 51F
F72f2	Fuse for water pump, lavatory, illumination	32E 51E
F72f3	Fuse for illumination, odor extraction hood	19E
F72f5	Fuse for lifting/tilting roof window	2E
G1/1	Additional battery	2L 19L 32L 51L
J1/1	Voltage supply cabinet connector sleeve	35F
J2/1	Right D-pillar ground connector sleeve	39G
J4/1	Roof illumination connector sleeve	41G
M77/1	Fresh water pump	60A

S25/20	Main battery switch	1H 18H 31H 50H
S190/1	Switch for kitchen water tap	56A
S190/2	Switch for shower	58L
S190/5	Switch for roof halogen bulb	41L
S190/7	Switch for washroom fluorescent lamp	35L
S190/8	Door contact switch for luggage compartment lamp	11L
S190/9	Switch for kitchen halogen lamp	23L
S190/10	Switch for roof fluorescent lamp	2A
S190/11	Water pump switch	52A
S190/12	Switch for shower, outer	59L
S190/13	Mains water switch	53A
W29/3	Ground (left C-pillar)	53L 61L
W29/9	Ground (right D-pillar)	13L 40L
W48	Ground (left rear roof frame)	4L 16L 28L 30L 48L
X7	High roof connector	5F
X7/1	Connector for roof stowage box	21F
X7/2	Connector for cabinet	34F
X7/3	Connector for lavatory	54F
X7/4	Connector for lavatory	56F
X58/29	12 V socket	22L

AS00.00-Z-0017-01B	Risk of injury caused by scraping or cutting body parts on sharp vehicle parts	Always wear protective gloves when working on or near sharp and non-deburred vehicle parts. Deburr repair panels.	 Danger!
--------------------	---	---	---

Potential risks

Risk of injury

When performing work on body parts, major assembly parts and suspension parts that, due to their manufacturing process or their finishing stage, have not yet been deburred, there is the risk of cutting, ripping and scraping body parts on non-deburred edges.



D00.00-1126-01

Safety precautions/instructions

- Wear protective gloves.
- Deburr repair panels and edges that have been cut.
- Avoid applying too much pressure when working, otherwise there is the danger of slipping.

First aid measures:

Move the victim out of the hazard area. Treat the wound to stop the bleeding. If any arteries have been cut, the flow of blood to that area must be stopped (by applying a tourniquet above the injured area).

 Consult a physician immediately in the case of serious injuries (heavy bleeding, severed limbs, etc.), signs of blood poisoning or if victim is unconscious.

AS54.10-Z-0001-01A	Risk of explosion from gas. Risk of poisoning and burns from swallowing battery electrolyte. Risk of injury to eyes and skin as result of caustic burns from battery electrolyte or from handling damaged lead-acid batteries.	No fire, sparks, naked flames or smoking. Wear acid-resistant gloves, clothing and eye protection. Pour battery electrolyte only into suitable and appropriately marked containers.	 Danger!
--------------------	--	---	---

Possible hazards

Risk of explosion

A highly explosive gas mixture is produced when charging lead-acid batteries.

Risk of poisoning

If battery electrolyte is swallowed, this can result in manifestations of poisoning such as headaches, dizziness, stomach pain, respiratory paralysis, unconsciousness, vomiting and cramps.

Battery electrolyte mist causes caustic burns to the eyes.

If swallowed, this can result in caustic burns to the mucous membranes and respiratory passages.

The absorption of lead in the body can cause damage to blood, nerves and kidneys; in addition, lead compounds are considered to represent a reproductive hazard.

- Keep lead-acid batteries and battery electrolyte away from unauthorized persons.
- Pour battery electrolyte only into suitable and appropriately marked containers.
- Always store lead-acid batteries horizontally.
- Ensure the gassing line is properly connected.
- Ensure the gassing line does not have any kinks and is not blocked at any point.
- Pay attention to instructions for use of the particular lead-acid battery and the operating instructions of the vehicle.
- Wear acid-resistant clothing and eye protection with side guards.

Injury hazard

Battery electrolyte contains sulfuric acid which can cause severe caustic burns to skin and eyes. Strict caution is required when handling damaged lead-acid batteries (removing from vehicle damaged in accident) because of the sharp edges on the fractured housing and direct contact with the lead plates.

Protective measures/rules of conduct

- Charge lead-acid batteries only in well ventilated areas.
- No fire, sparks, naked flames or smoking.
- Do not place any tool or other conducting objects onto the lead-acid battery (risk of short-circuit).
- Disconnect and remove lead-acid batteries for charging.
- Always **disconnect negative terminal** first of all; always **connect positive terminal** first of all.
- Do not switch on the charger until after it has been connected to the terminals; switch it off before disconnecting.

First-aid measures

Eye contact

- Rinse out eyes immediately with plenty of water.

Skin contact

- Take off moistened clothing.
- Immediately neutralize acid splashes on skin or clothing with acid converter or soap suds and rinse off with plenty of water.

Inhaling battery electrolyte mist

- Take the affected person out into the fresh air.

Swallowing battery electrolyte

- Have the person affected drink plenty of water with the addition of activated charcoal.

As a general rule, the person affected should consult a medical service or doctor after first-

aid has been rendered.

Fire protection measures

Suitable extinguishing agents

- CO2 and dry extinguishing agent

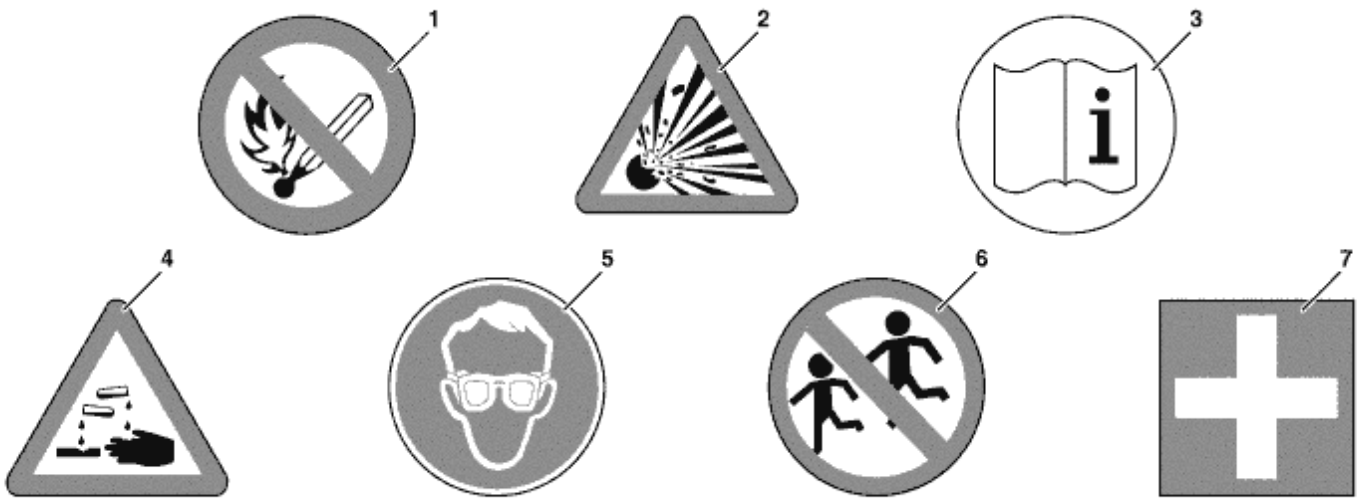

P54.10-0270-08

Warning instructions for lead-acid batteries

1 No fire, sparks, naked flames or smoking

2 Risk of explosion

3 Pay attention to operating instructions

4 Risk of caustic burns

5 Wear eye protection

6 Keep away from children

7 First-aid



- Do not store lead-acid batteries for longer periods of time in direct sunlight.
- Always store lead lead-acid batteries horizontally to prevent acid leaking out and do not tilt during transportation.
- Flat or defective acid lead batteries may freeze, therefore store away from frost.
- Keep tools and other conductive objects away from batteries (risk of short-circuit).
- Avoid polarity reversal and short-circuits.
- To prevent unintentional sparking, turn off all switchable current consumers and the engine before removing and installing lead-acid batteries.
- Always **disconnect the negative terminal** first; always **connect the positive terminal** first.

- Switch on the charging equipment only after connecting to the terminals; switch off the charging equipment before disconnecting from the terminals.
- Only charge lead-acid batteries with direct current (DC). The recommended charging current for slow charging is 10 % capacity and 50 % capacity for fast charging.
- When fast charging, ensure that the housing of the lead-acid battery does not heat up too much (< 55 °C).
- Whenever possible, lead-acid batteries should be stored in a clean and dry place.
- We recommend greasing the terminals slightly with battery-terminal grease.
- Lead-acid batteries should not be stored for longer periods of time without recharging.
- The negative terminal should be disconnected if the lead-acid battery remains in a parked or unused vehicle for a longer period of time.

AS00.00-Z-0027-01A	Risk of death caused by coming into contact with electrical parts of the 110 V system. Risk of injury caused by burns, which can be produced by electrical shocks or by body parts coming in direct contact with electrical currents.	Do not touch any conductive parts of the 110 V system.	 Danger!
--------------------	---	--	---

Potential risks

Risk of death caused by electric shock

Risk of death caused by coming into contact with electrical parts of the 110 V system. Electric shocks can cause fibrillation of the heart or even cardiac arrest. The effects of an electric shock may sometimes first appear after several minutes; for this reason always consult a physician.



Risk of injury caused by burns

Electric shock or direct body contact with a power source can lead to burns or scalding.

D00.00-1129-01

Safety precautions/instructions

The 110 V power supply should not be hooked up to an outside socket during any repair work.

Do not touch any conductive parts of the 110 V system.

Before starting any work, the 110 V system must:

- be disconnected
- be secured from being turned on again
- be tested for no voltage.

Before starting any work on the 110 V system, parts which are to be worked on, should be grounded and short circuited.

All work involving assembly and disassembly and all function tests may only be performed by authorized personnel.

First aid measures

- Separate the victim from the source of electricity. Use protective gloves, a wooden board or a wooden ladder to push or pull the victim out of the danger zone.

Workshop personnel must demonstrate their knowledge in accordance with the OSHA requirements (Occupational Safety and Health Administration) and be able to act accordingly.

All work involving assembly and disassembly and all function tests must be performed as per the relevant regulations and requirements of the ANSI, NEMA, NFPA and UL standards.

Persons who have electronic implants (e.g. heart pacemakers) must not perform any work on conductive parts of the 110V system.

When performing any repair work on the 110 V system, proper insulated protective clothing must be worn and insulated tools and protective devices must be used as per the safety regulations.

- Treat **burns** by placing the affected area under cold running water for at least 15 min. Cover the affected area with a sterile Metalline burn compress. Apply the Metalline coated side to the burn and wrap loosely with a gauze bandage or a triangular bandage. The burn compress will not

i First attempt to turn off the power.

- Check for breathing. If there is no breathing or insufficient breathing, the preferable action is to perform mouth-to-mouth resuscitation. If necessary, carry out CPR.
- If victim is unconscious, but breathing, place victim in the recovery position.

stick to the wound, is heat insulating and protects the wound from contamination.

i If any of these symptoms occur, consult a physician immediately.

AR86.60-D-0050-01A	Remove/install floor in cabinet		
⚠ Danger!	Risk of injury caused by body parts becoming jammed, pinched or severed by doors, covers, flaps or by loose components	Keep body parts well clear when moving doors, covers, flaps and components. Wear protective gloves and protective shoes.	AS00.00-Z-0025-01A



110 589 03 59 00

Mounting wedge

1 Open roller blind.

2 Remove floor carrier (1) from corresponding stowage floor .

3 Remove stowage floor (2) to be taken out from hanging cabinet in longitudinal direction

4 Install in reverse sequence.

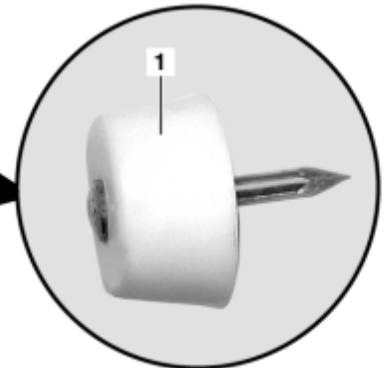
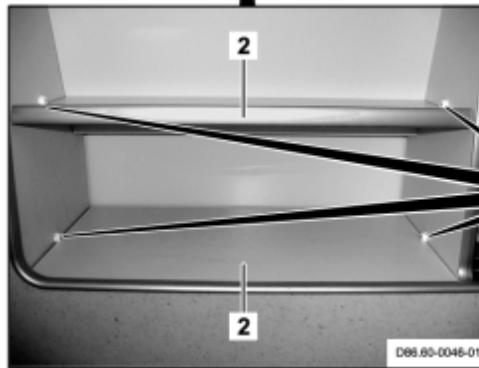

D86.60-0047-06

AR86.60-D-0051-01A

Remove/install cover panel from hanging cabinet

1 Open stowage compartment flap on lateral hanging cabinet (3).

2 Unscrew bolts (1).

3 Remove cover panel (2).

4 Install in the reverse order.



When tightening bolts (1) ensure that no electrical lines are pinched below the cover panel to prevent damaging the leads and avoiding malfunctions of the components.

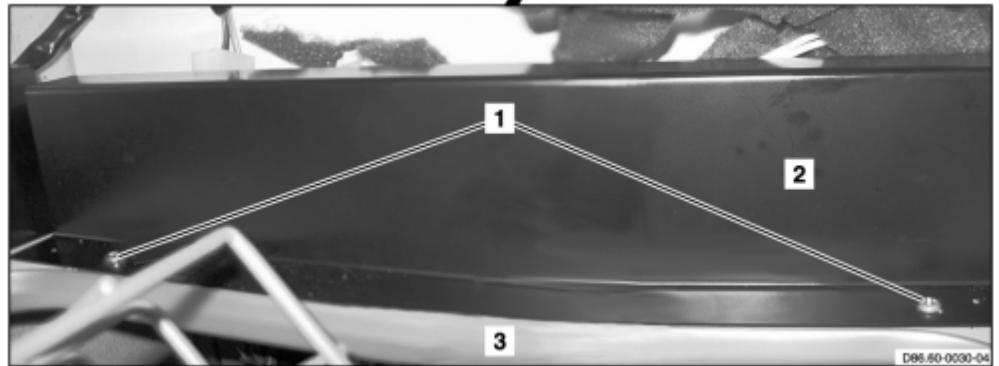
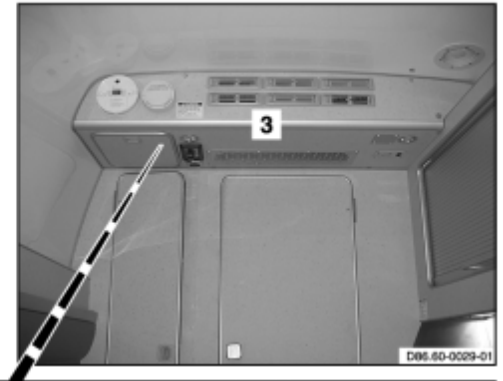

D86.60-0031-06

AR86.60-D-0051-01B

Remove/ install cover panel from hanging cabinet

1 Open stowage compartment on lateral hanging cabinet (3).

2 Unscrew bolts (1).

3 Remove cover panel (2).

4 Install in the reverse order.



When tightening bolts (1) ensure that no electrical lines are pinched below the cover panel to prevent damaging the leads and avoiding malfunctions of the components.

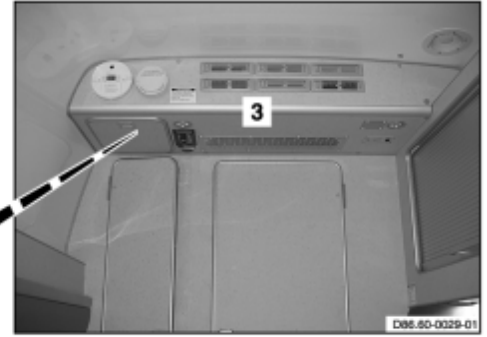
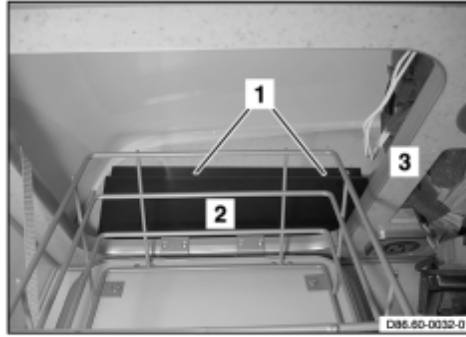

D86.60-0033-04

AR68.30-D-4630-01A

Remove/ install kitchen element front paneling

1 Move bench seat (1) toward front.

i See Operating Instructions

2 Remove upholstery (2).

3 Remove caps from bolts (4)

4 Unscrew bolts (4)

5 Remove paneling (3)

6 Install in the reverse order.

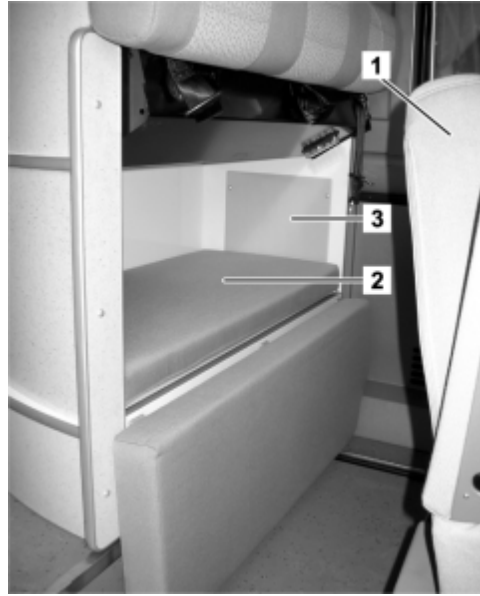

D68.30-1121-02

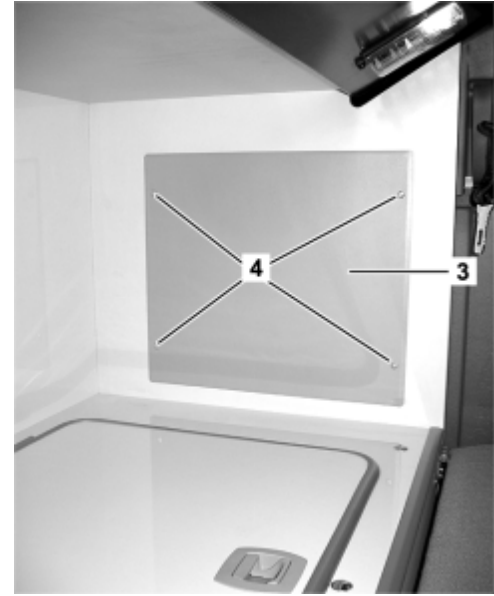

D68.30-1122-02

AS00.00-Z-0025-01A	Risk of injury caused by body parts becoming jammed, pinched or severed by doors, covers, flaps or by loose components	Keep body parts well clear when moving doors, covers, flaps and components. Wear protective gloves and protective shoes.	 Danger!
--------------------	---	--	---

Potential risks

Risk of injury

Body parts can be pinched or severed when working on doors, covers, flaps or loose components.



D00.00-1113-01

Safety precautions/instructions

- Secure doors, covers and flaps in such a way that they do not close unintentionally.
- Support or secure loose components in their positions with suitable means so that they do not fall.
- Wear protective gloves and protective shoes.
- Have another person help when removing or installing heavy components or when working on hard to reach components.

First aid measures:

Move the victim out of the risk area.
Treat the wound to stop the bleeding. If any arteries have been cut, the flow of blood to that area must be stopped (by applying a tourniquet above the injured area).

 Consult a physician immediately in the case of serious injuries (heavy bleeding, severed limbs, etc.), swelling, broken bones, or if victim is unconscious.

AR54.21-D-0030-01A

Remove/install cover of roof air conditioning switched-mode power supply

 Tape assembly area (marking) with friction tape in order to avoid damage when removing and installing the cover of the switched-mode power supply (1).

1 Unscrew bolts (2).

2 Remove cover of switched-mode power supply (1).

3 Install in the reverse order.

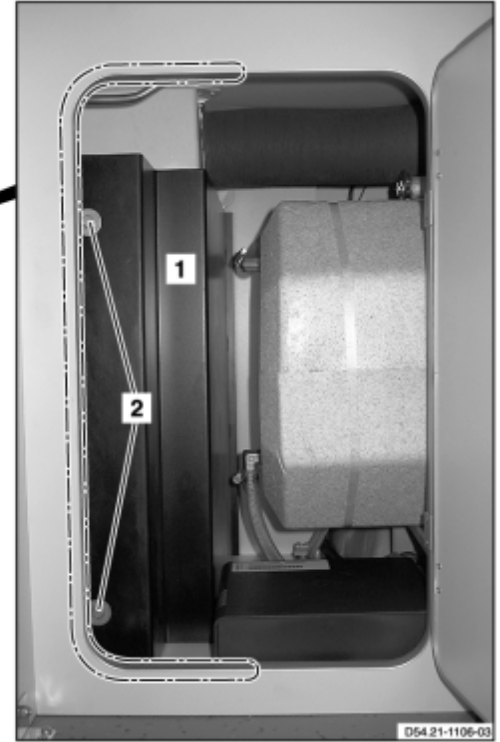

D54.21-1107-06

AR54.21-D-0021-01A

Carry out switch position of 1 or 2 batteries

1 Switches

5 Central electronics

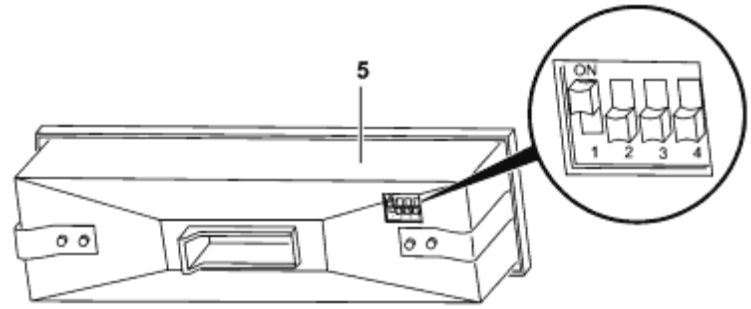

D54.21-1124-10

1 Press DOWN button (23) 1 ×

i Within 60 seconds after the central electronics (5) is in self-test mode

2 Check of symbol (7) and the multiple display (8).

i The symbol for battery operation (7) and 1b in the multiple display (8) means that switch (1) is adjusted to 1 additional battery in the vehicle.

i The symbol for battery operation (7) and 2b in the multiple display (8) means that switch (1) is adjusted to 2 additional batteries in the vehicle.

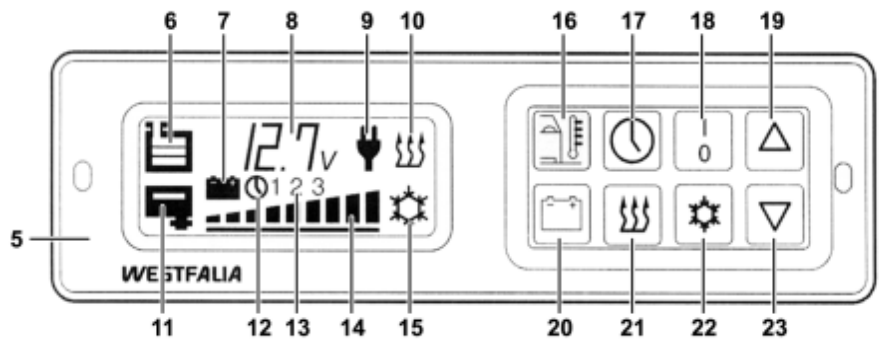

D54.21-1125-04

AR54.21-D-0021-02A

Carry out switch position for battery model 1 or 2

2 Switches

5 Central electronics

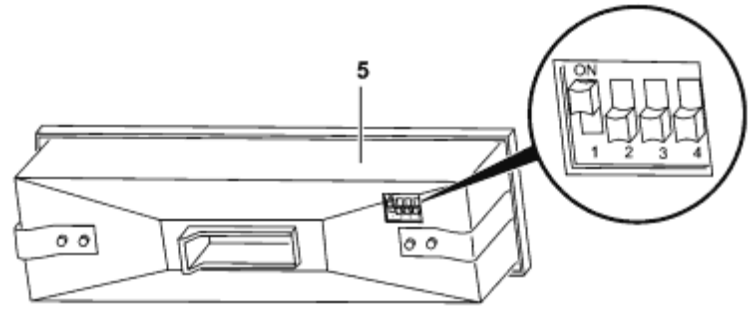

D54.21-1124-10

1 Press the down button (23) 2 ×

i Within 60 seconds after the central electronics (5) is in self-test mode

2 Check of symbol (7) and the multiple display (8).

i Symbol for battery operation (7) and 1A in the multiple display (8) means that switch (2) is adjusted to additional battery model 1 (sunshine) in the vehicle.

i Symbol for battery operation (7) and 2A in the multiple display (8) means that switch (2) is adjusted to additional battery model 2 (DELTA) in the vehicle.

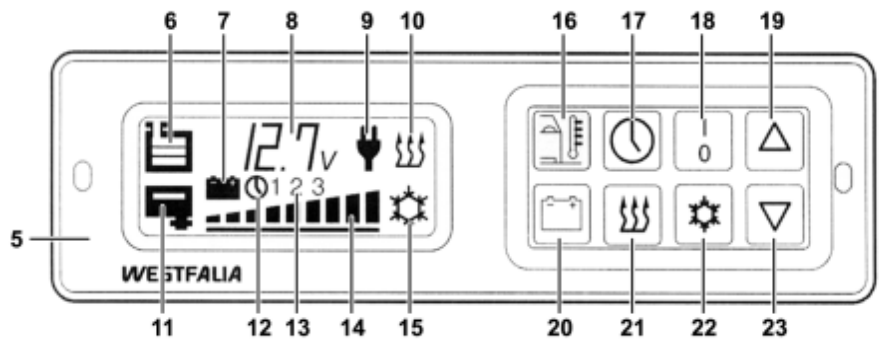

D54.21-1125-04

AR54.21-D-0021-03A

Carry out switch position for refrigerator box or refrigerator

3 Switches

5 Central electronics

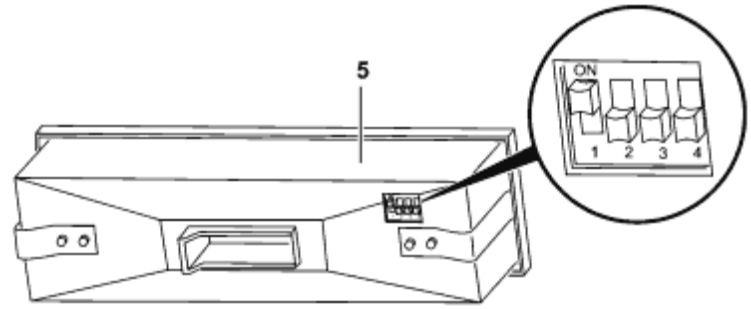

D54.21-1124-10

1 Press the down button (23) 3 ×

i Within 60 seconds after the central electronics (5) is in self-test mode

2 Check of symbol (15) and the multiple display (8).

i Symbol for refrigerator box, refrigerator (15) und CB in the multiple display (8) means that switch (3) is adjusted to the refrigerator box in the vehicle.

i Symbol for refrigerator box, refrigerator (15) und CS in the multiple display (8) means that switch (3) is adjusted to the refrigerator in the vehicle.

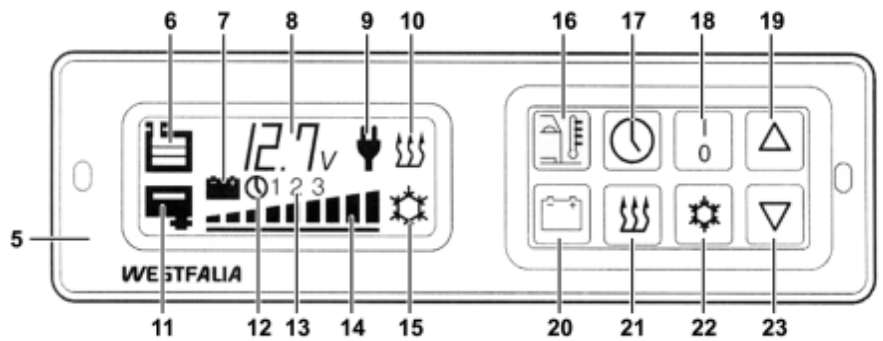

D54.21-1125-04

AR54.21-D-0021-04A

Carry out switch position degrees Celsius or degrees Fahrenheit

4 Switches

5 Central electronics

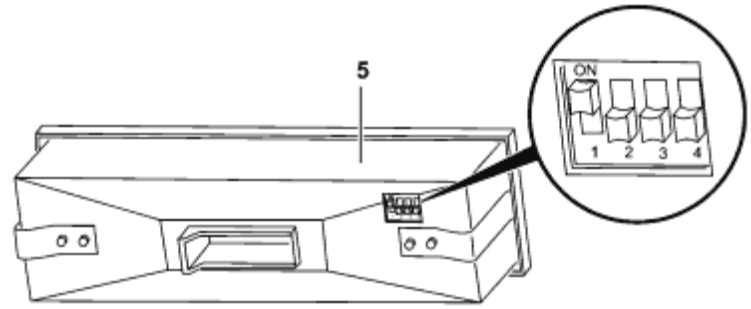

D54.21-1124-10

1 Press the down button (23) 4 ×

i Within 60 seconds after the central electronics (5) is in self-test mode

2 Check of multiple display (8).

i If °C is displayed in the multiple display (8), this means that switch (4) is adjusted to degrees Celsius.

i If °F is displayed in the multiple display (8), this means that switch (4) is adjusted to degrees Fahrenheit.

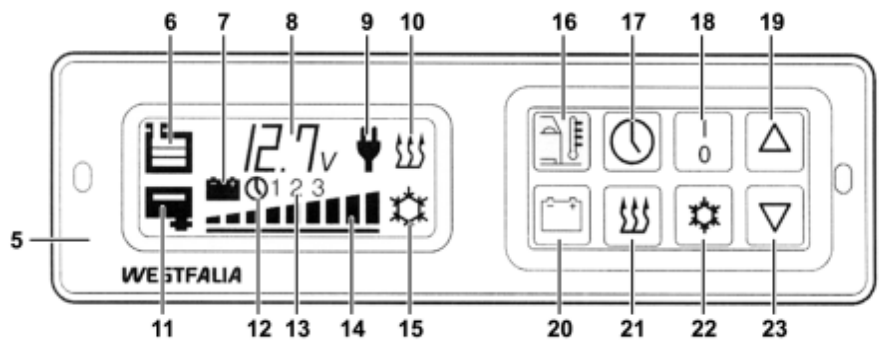

D54.21-1125-04

AR54.21-D-0021-05A

Carry out self-test for fresh water sensor

1 Press the down button (23) 5 ×

i Within 60 seconds after the central electronics (5) is in self-test mode

2 Check of multiple display (8).

i Symbol for fresh water level display (6) with 3 bars and OK in the multiple display (8) means that the values supplied by the fresh water sensor are OK.

i Symbol for fresh water level display (6) with 3 bars and F in the multiple display (8) means that the values supplied by the fresh water sensor are defective.

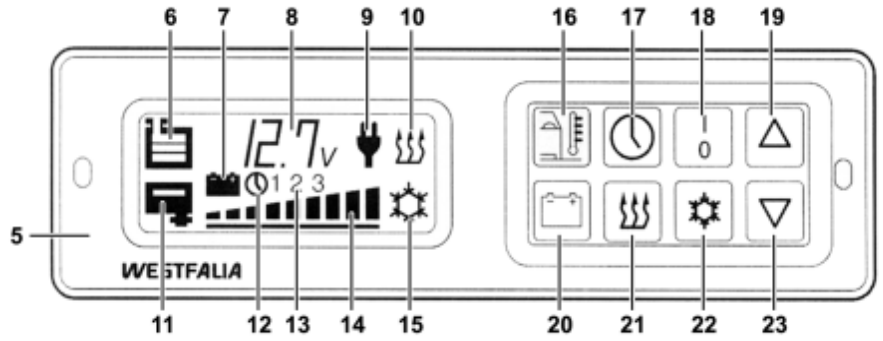

AR54.21-D-0021-06A

Carry out self-test for wastewater sensor

1 Press the down button (23) 6 ×

i Within 60 seconds after the central electronics (5) is in self-test mode

2 Check of multiple display (8).

i Symbol for wastewater level display (11) and OK in the multiple display (8) means that the values supplied by the wastewater sensor are OK.

i Symbol for wastewater level display (11) and F in the multiple display (8) means that the values supplied by the wastewater sensor are defective.

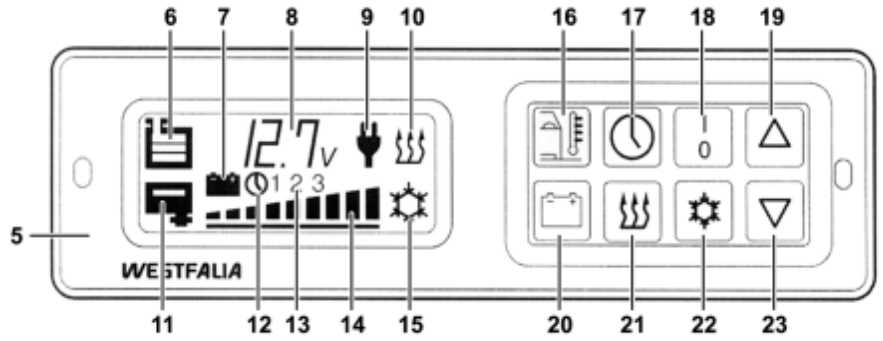

D54.21-1125-04

AR54.21-D-0021-07A

Carry out self-test for refrigerator temperature and refrigerator box temperature

1 Press the down button (23) 7 ×

i Within 60 seconds after the central electronics (5) is in self-test mode

2 Check of multiple display (8).

i The measured refrigerator temperature, refrigerator box temperature in °C or °F is displayed in the multiple display (8).

i If an F is displayed in the multiple display (8), this means that the values supplied by the temperature sensor of the refrigerator or refrigerator box are defective.

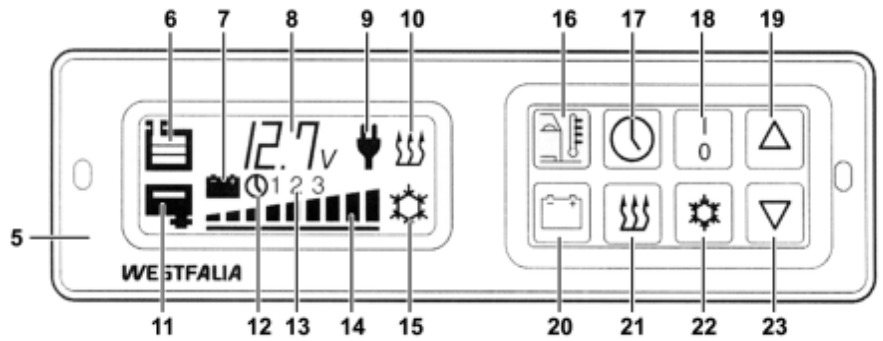

D54.21-1125-04

AR54.21-D-0021-08A

Carry out self-test for heater temperature

1 Press down button (23) 8 ×

i Within 60 seconds after the central electronics (5) is in self-test mode

2 Check of multiple display (8).

i The measured heater temperature in °C or °F is displayed in the multiple display (8).

i If an F is displayed in the multiple display (8), this means that the values supplied by the heater temperature sensor are defective.

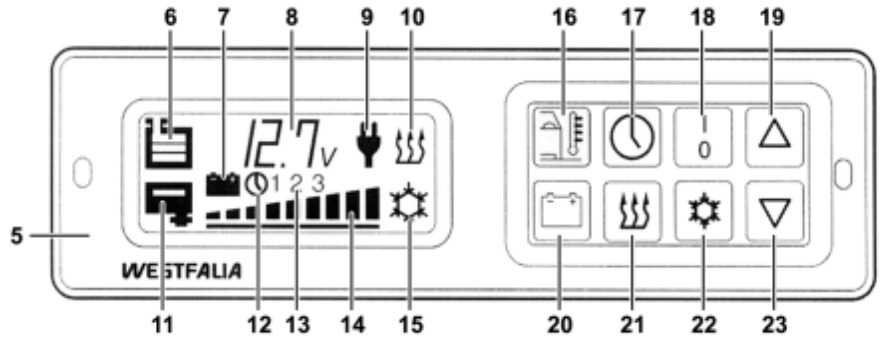

D54.21-1125-04

AR54.21-D-0021-09A

Carry out self-test for battery current

1 Press the down button (23) 9 ×

i Within 60 seconds after the central electronics (5) is in self-test mode

2 Check of multiple display (8).

i Symbol for battery mode (7) and the measured battery current are displayed in the multiple display (8).

i If an F is displayed in the multiple display (8), this means that the values of battery current supplied are defective.

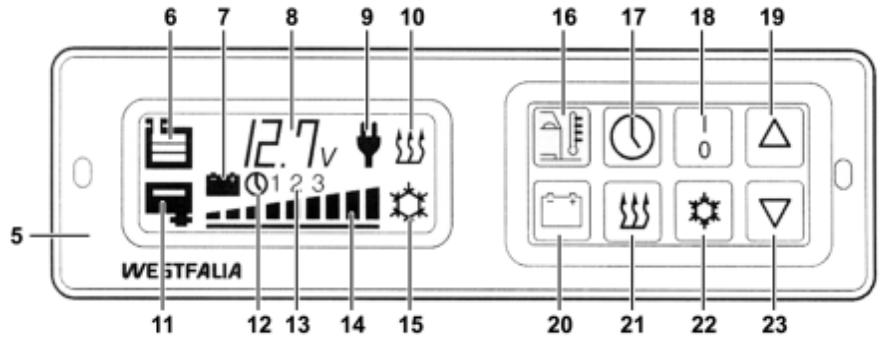

D54.21-1125-04

AR54.21-D-0021-10A

Carry out self-test for refrigerator and refrigerator box

1 Press the down button (23) 10 ×

i Within 60 seconds after the central electronics (5) is in self-test mode

2 Check of multiple display (8).

i The cooling unit starts after 5 seconds.

i Symbol for refrigerator box, refrigerator (15) and measured current are displayed in the multiple display (8). If the value is 4.5 to 5 A, the cooling unit is OK.

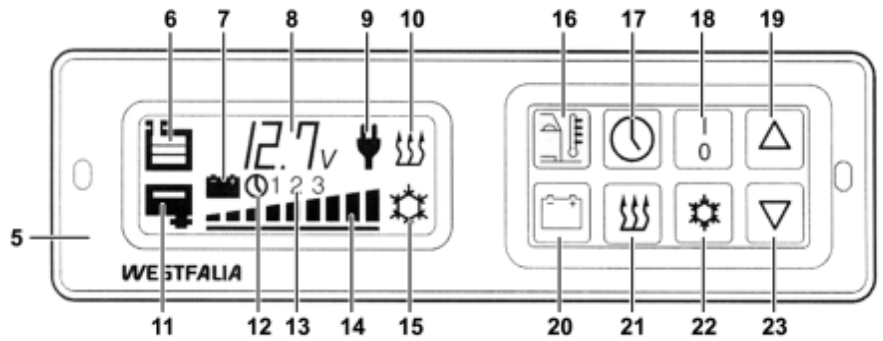

D54.21-1125-04

AR54.21-D-0021-11A

Carry out self-test for heater

1 Press the down button (23) 11 ×

i Within 60 seconds after the central electronics (5) is in self-test mode

2 Check of multiple display (8).

i The blower starts after 5 seconds and the glow plug after 30 seconds.

i Symbol for stationary heater mode (10) and measured current are displayed in the multiple display (8). If the value is 16 to 20 A, the heater is OK.

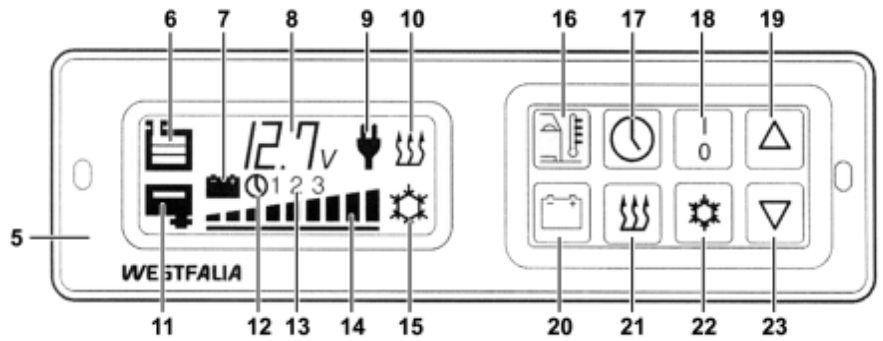

D54.21-1125-04

1 Press the down button (23) 12 ×

i Within 60 seconds after the central electronics (5) is in self-test mode

2 Press outside temperature button (16).

3 Check of multiple display (8).

i If OK is displayed in the multiple display (8), this means that the outside temperature button (16) is OK.

i If F is displayed in the multiple display (8), this means that the outside temperature button (16) has a fault.

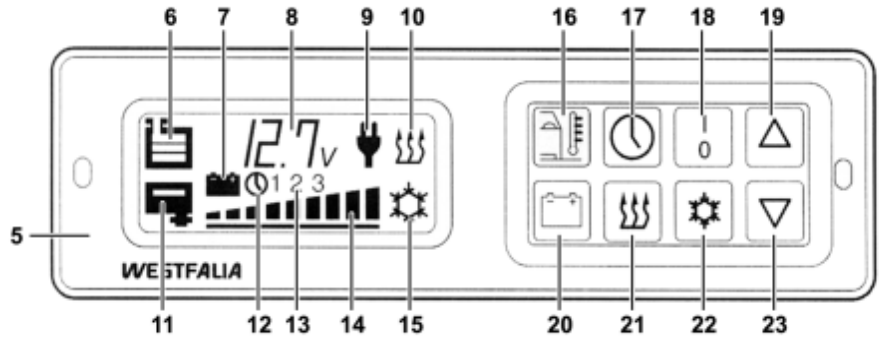

AR54.21-D-0021-13A

Carry out self-test for battery voltage button

1 Press the down button (23) 13 ×

i Within 60 seconds after the central electronics (5) is in self-test mode

2 Press battery voltage button (20).

3 Check of multiple display (8).

i If OK is displayed in the multiple display (8), this means that the battery voltage button (20) is OK.

i If F is displayed in the multiple display (8), this means that the battery voltage button (20) has a fault.

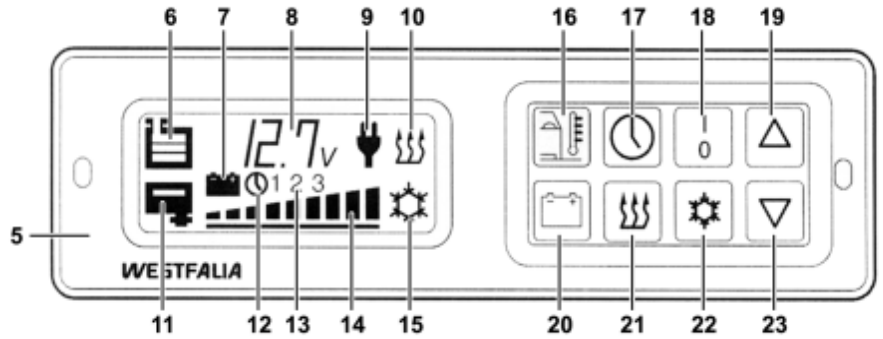

D54.21-1125-04

AR54.21-D-0021-14A

Carry out self-test for timer button

1 Press the down button (23) 14 ×

i Within 60 seconds after the central electronics (5) is in self-test mode

2 Press timer button (17).

3 Check of multiple display (8).

i If OK is displayed in the multiple display (8), this means that the timer button (17) is OK.

i If F is displayed in the multiple display (8), this means that the timer button (17) has a fault.

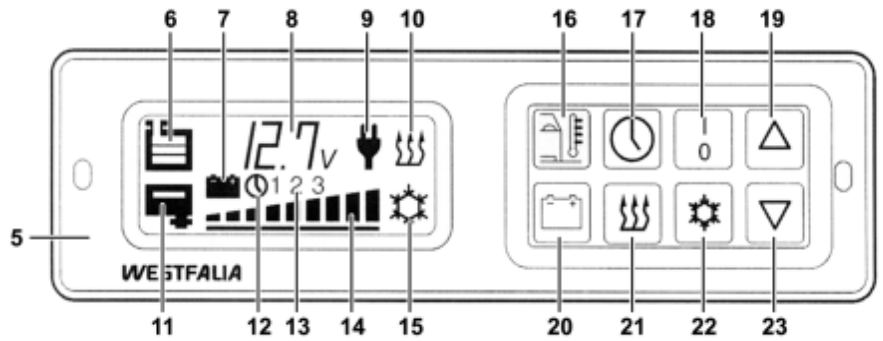

D54.21-1125-04

AR54.21-D-0021-15A

Carry out self-test for heater button

1 Press the down button (23) 15 ×

i Within 60 seconds after the central electronics (5) is in self-test mode

2 Press heater button (21).

3 Check of multiple display (8).

i If OK is displayed in the multiple display (8), this means that the heater button (21) is OK.

i If F is displayed in the multiple display (8), this means that the heater button (21) has a fault.

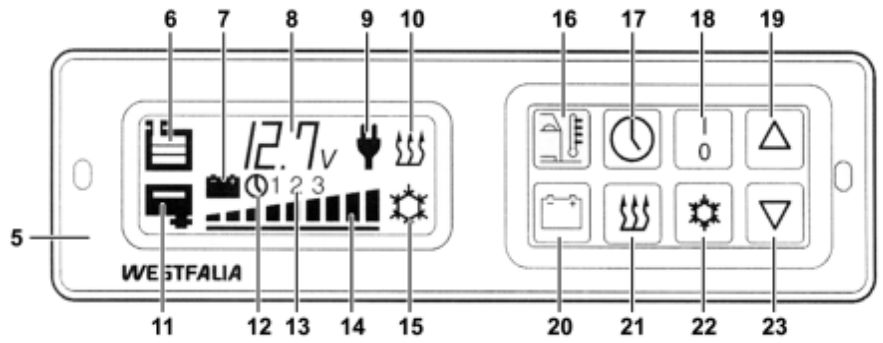

D54.21-1125-04

AR54.21-D-0021-16A

Carry out self-test for ON-OFF button

1 Press the down button (23) 16 ×

i Within 60 seconds after the central electronics (5) is in self-test mode

2 Press ON-OFF button (18).

3 Check of multiple display (8).

i If OK is displayed in the multiple display (8), this means that the ON-OFF button (18) is OK.

i If F is displayed in the multiple display (8), this means that the ON-OFF button (18) has a fault.

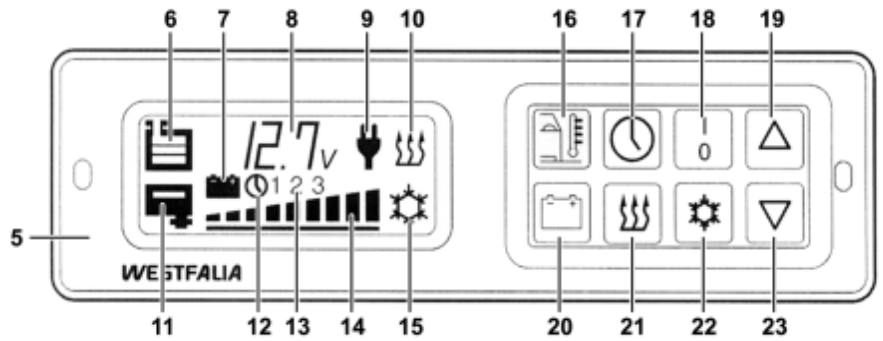

AR54.21-D-0021-17A

Carry out self-test for refrigerator button, refrigerator box button

1 Press the down button (23) 17 ×

i Within 60 seconds after the central electronics (5) is in self-test mode

2 Press refrigerator box button, refrigerator button (22).

3 Check of multiple display (8).

i If OK is displayed in the multiple display (8), this means that the refrigerator box button, refrigerator button (22) is OK.

i If F is displayed in the multiple display (8), this means that the refrigerator box button, refrigerator button (22) has a fault.

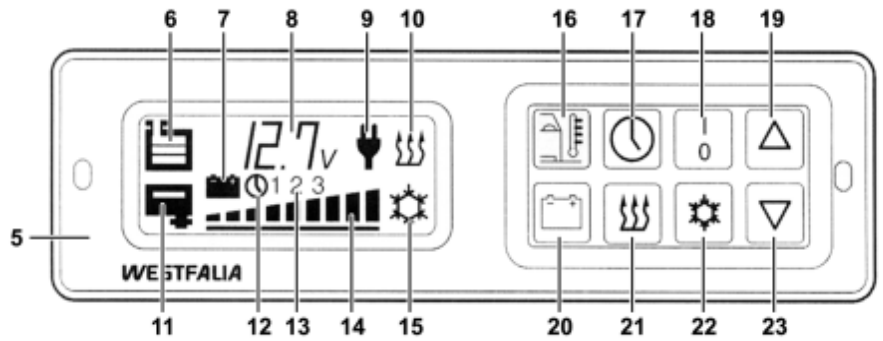

D54.21-1125-04

AR54.21-D-0021-18A

n Carry out self-test for up button

1 Press the down button (23) 18 ×

i Within 60 seconds after the central electronics (5) is in self-test mode

2 Press UP button (19).

3 Check of multiple display (8).

i If OK is displayed in the multiple display (8), this means that the UP button (19) is OK.

i If F is displayed in the multiple display (8), this means that the UP button (19) has a fault.

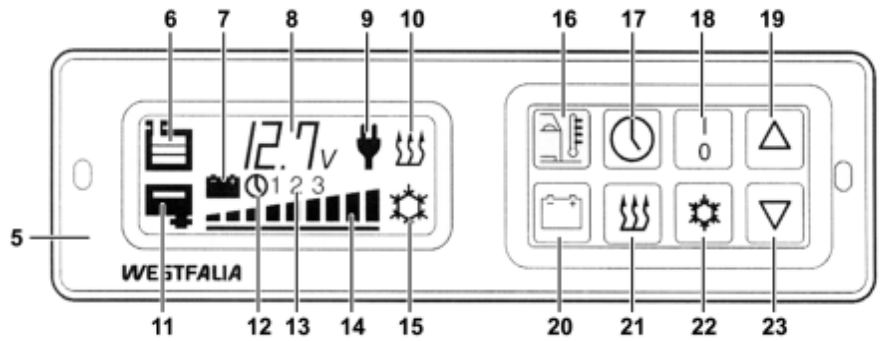

D54.21-1125-04

AH54.00-P-1000-01A	Evaluating electronic components after repair and painting work and after accidents	All models	
--------------------	---	------------	---

1. With paint drying in drying oven

Electronic components, such as the switching unit for the ignition system, the control unit for the electronic fuel/diesel injection system, the ABS system, airbag, emergency tensioning retractors etc. may only be heated up to an object temperature of maximum 90 °C.

In cases of doubt the temperature at these points should be checked by a series of measurements (remove electronic components beforehand) by means of a mercury maximum thermometer during the baking phase.

If the maximum permissible temperature is not exceeded, the electronic components need not be removed.

No particular safety measures are required at an object temperature up to max. 60 °C (air injection temperature max. 90 °C).

 If electronic components, such as the ABS control unit, have been removed for repair and are then used again, these should be checked for proper operation after assembly.

Read fault memory and erase

2. With welding

Always disconnect and cover the negative terminal of the battery. Disconnect airbag 10-pin data link connector (color red) in the right footwell after waiting for 2 seconds after disconnecting the battery or as of 07/93 detach the coupling on the airbag control unit using the insertion and removal aid.

3. After accidents

Replacing electronic control units after an accident is only necessary if at least one of the following conditions is met:

- The housing is recognizably deformed or damaged.
- The contact surface or bearing bracket is deformed; externally the unit does not appear damaged.
- The connector is damaged or corroded by moisture.
- Faults are established by a function test or self-diagnosis of the unit.

AH00.00-N-0001-01A	Notes on self-locking nuts and bolts	All models	
--------------------	--------------------------------------	------------	---

Important repair information

 Bolts with locking splines, micro-encapsulated bolts and self-locking nuts must always be replaced after being used once.

There is an increased risk of injury when unscrewing micro-encapsulated bolts due to the sudden breakaway torque.

Before new micro-encapsulated bolts are screwed in, the mating thread must be re-cut in order to remove all the residue of the old bolt locking compound.

AS86.00-Z-0002-01A	Risk of injury caused by hot water exiting from the lines of the fresh water system	Shut off the water heater in a timely manner before starting repair work. Let the water in the lines and in the components of the fresh water system cool down to room temperature.	 Danger!
--------------------	--	---	---

Potential risks

Risk of injury

If the water heater was in operation up to the start of the repair work, then during repair work, scalding could occur from contact with the hot water or injuries could occur from components under high pressure.

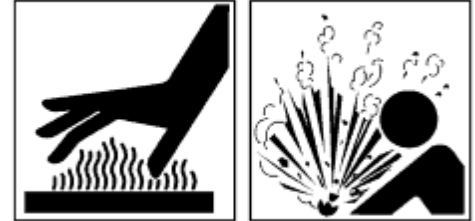

D00.00-1130-01

Safety precautions/instructions

- Shut off the water heater in a timely manner before starting repair work.
- Let water in the lines cool down to room temperature.
- Let components of the system cool down to room temperature.
- Wear protective gloves, protective clothing and eye protection.
- Workshop personnel must demonstrate their knowledge in accordance with the OSHA requirements (Occupational Safety and Health Administration) and be able to act accordingly.
- All work involving assembly and disassembly and all leak tests must be performed as per the relevant regulations and requirements of the ANSI, NFPA and UL standards.

First aid measures:

Move the victim out of the risk area.

If scalding occurs: Remove clothes immediately. Place the affected body part under cold running water for at least 15 min. Cover the affected area with a sterile Metalline burn compress. Apply the Metalline coated side to the burn and wrap loosely with a gauze bandage or a triangular bandage. The burn compress will not stick to the wound, is heat insulating and protects the wound from contamination.

Do not cover minor scalds (no blistering present) with bandages, but rather leave them exposed to the open air.

 If injuries are serious, consult a physician immediately.

AS67.00-Z-0002-01A	Risk of injury from contusions to hands if window glass is not secured	Secure windows against falling down.	 Danger!
--------------------	--	--------------------------------------	---

Injury hazard

When working on the power windows or the windows in the vehicle doors, the unsecured window can fall down and can cause injury by pinching hands

Rules of behavior/protective measures

Secure window against falling down with shop-made retaining hook or special tool.

AS65.00-Z-0002-01B	Risk of death caused by falling down from the roof of the vehicle. Risk of injury to other persons caused by falling objects during work in the area of the roof.	Work on or in the area of the vehicle's roof may only be performed on suitable equipment (ladders, scaffolds, lifting platforms). Sufficiently secure the area to be worked in.	 Danger!
--------------------	--	---	---

Potential risks

Risk of death

Problems with maintaining a center of balance can occur when lifting heavy components or when in an unfavorable working position. This can cause persons working on or in the area of the roof to fall.



Risk of injury

During work on a vehicle roof, persons in the immediate area of the vehicle may suffer injuries caused by objects falling, dropping, slipping or rolling off the vehicle.

D00.00-1121-01

Safety precautions/instructions

- Wear protective work shoes.
- Use suitable lifting devices for large and heavy components or, if necessary, get someone to help.
- Use only ladders, scaffolds or lifting platforms that are equipped with devices that prevent people from falling.
- Only perform work on a vehicle's roof if the immediate area is physically closed off to all other persons.

First aid measures

First aid should be performed by a person who has the qualification in accordance with the OSHA requirements (Occupational Safety and Health Administration).

 If injuries are serious, consult a physician immediately.

AH60.00-P-0003-01N	General information on riveting	Model 168, 169, 171, 199, 203, 209, 211, 215, 219, 230, 240, 414, 639, 903	i
--------------------	---------------------------------	--	----------

General

DIN 8593 describes rivets as non-detachable fasteners for parts of the same or different materials.

The connection is accomplished by the deformation of the fastening element (rivet).

Riveting is a type of connection which has been tested and approved by DaimlerChrysler and which has significant advantages over MIG plug welding in terms of corrosion protection following repair work.

Deformation of joined parts due to heating does not occur during riveting as connections are made cold.

For this reason, the priorities for fastening techniques for repair have been redefined as follows:

1. Resistance spot welding
2. Rivets
3. MAG plug welding and other welds

Rivet types, their application and positioning are described in the respective repair documents.

For the repair of hybrid construction vehicles, joints are both blind riveted and bonded.

Bonding achieves greater strength and ensures that joints are properly sealed.

Rivet materials

The rivet should always be of the same material as the components to be connected, or at least of the same type of material in order to avoid damage from electrochemical corrosion or loosening as a result of various thermal expansion rates.

The primary rivet materials are:

- Steel
- Aluminum alloys

i Standard bonded load-bearing sections

For standard bonded load-bearing sections that are not rebonded following accident repair, the number of rivets is indicated in the specific repair description.

Always observe these specifications to ensure operating stability

i Always seal riveted flanges with body sealant.

Rivet forms for hybrid construction vehicles

- Various types of blind rivets.

Preparation of rivet points

Always drill and deburr rivet holes.

To prevent notching in the rivet and good flow characteristics of the shaft material in the hole, the edges of the rivet holes should be chamfered or countersunk.

Riveting procedure

- Clean connection points
- Insert blind rivet
- Pull back pin with hand riveter or electric or hydraulic riveter until it tears off at the predetermined fracture point.

AR72.20-D-2411-01B

Installing door strap

Nm Rear door

Number	Designation	Models
		690.6, 901, 902, 903, 904
BA72.20-N-1003-01A	Screw, door strap to rear door	Nm 10

Version C (old version)

 Install threaded plate (4) with short leg pointing towards hinge side.

Version D (modified version)

 Install threaded plate (4) with long leg pointing toward hinge side.

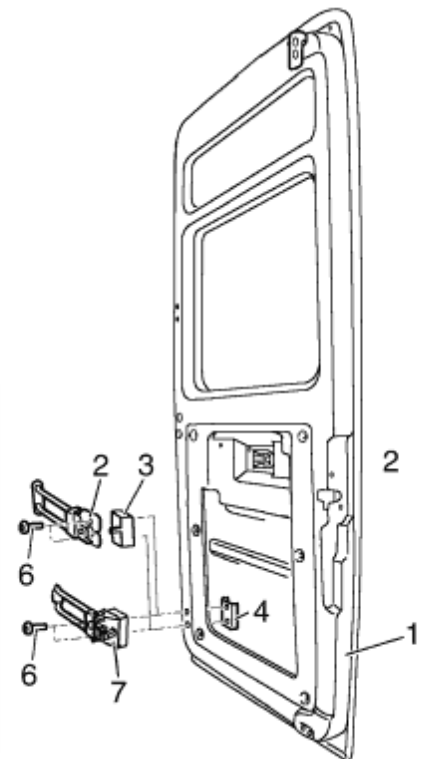
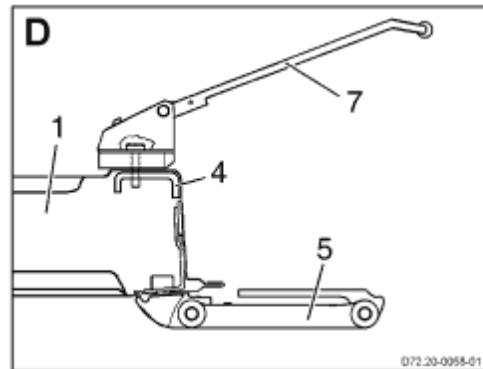
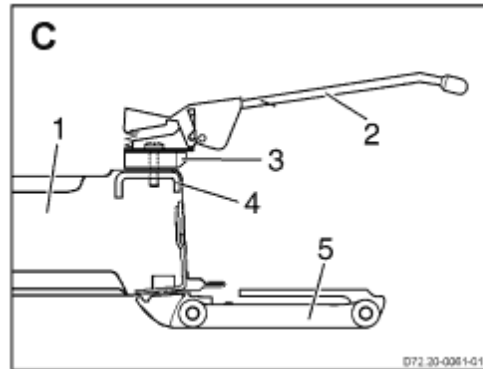

D72.20-0056-06



MODEL901.06 /36 /37 /46 /66 /67, 902.06 /07 /36 /37 /46 /47 /66 /67, 903.06 /07 /36 /37 /46 /47 /66 /67,
904.06 /36 /46 /66, 690.63 /64

MODELYD1, YD2, YD3, YD4, YD5, YD6, YD7, WD1, WD2, WD3, WD6, WD7

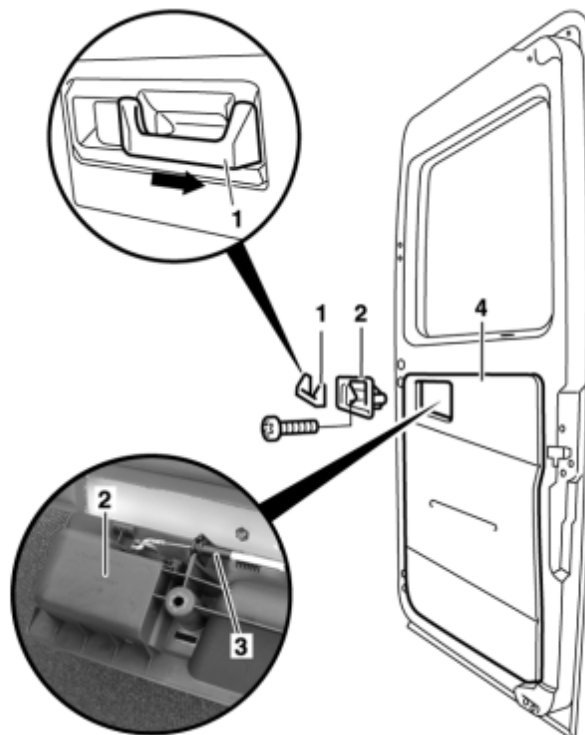
- 1 Panel
- 2 Inside door opener
- 3 Release cable
- 4 Door paneling



D72.20-1173-06

	Remove/Install		
1	Push covering (1) in direction of arrow		
2	Unscrew inside door opener (2) and pull out of door paneling (4)		BA72.20-N-1005-01A
3	Unhook release cable (3) on inside door opener (2)		
4	Install in the reverse order		

 Rear door

Number	Designation	Models	Model
		690.6, 901, 902, 903, 904	WD1/WD2/ WD3/WD6/ WD7/YD1/ YD2/YD3/ YD4/YD5/

				YD6/YD7
BA72.20-N-1005-01A	Bolt for inner actuation on tailgate	Nm	10	10

MODEL901.06 /36 /37 /46 /66 /67, 902.06 /07 /36 /37 /46 /47 /66 /67, 903.06 /07 /36 /37 /46 /47 /66 /67,
904.06 /36 /46 /66 except CODE (W90) Delete item rear doors
MODEL690.63/ 64

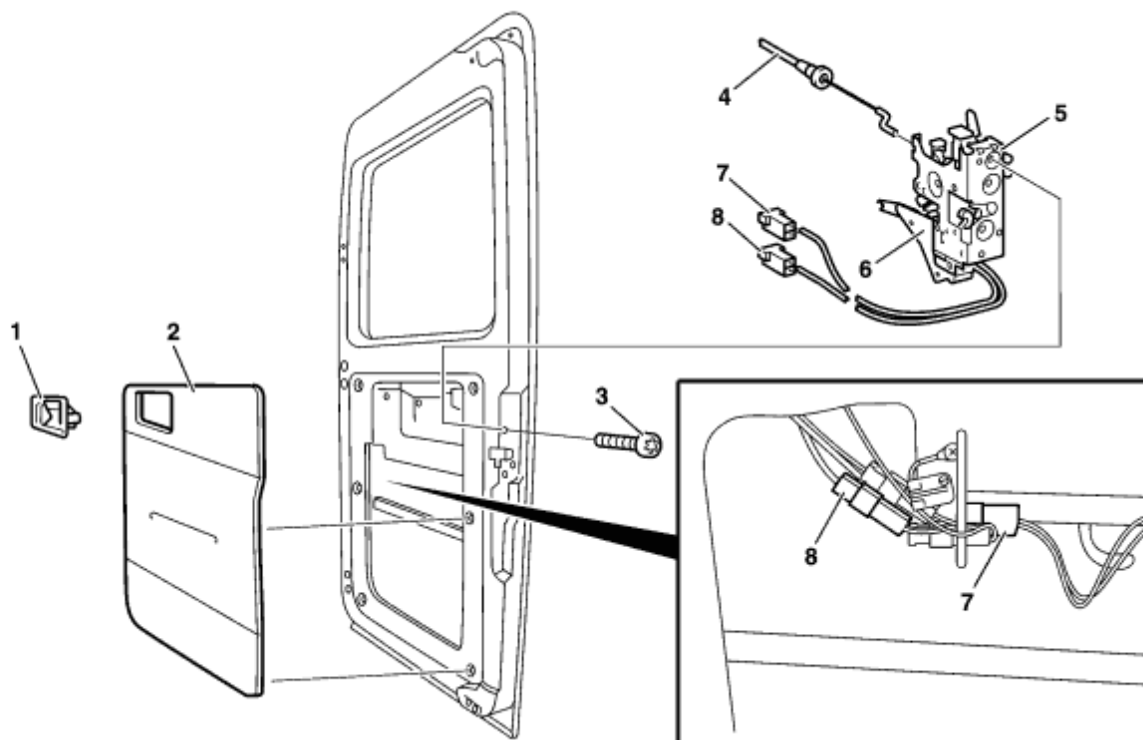





D72.20-1175-09

1 Inside door opener
2 Door paneling
3 Bolt

4 Release cable
5 Door lock
6 Central locking motor

7 Connector
8 Connector

	Remove/Install		
1	Remove inside door opener (1)		AR72.20-D-4075A
2.1	Remove door paneling (2) from rear door	Except freezer vehicle or refrigerator vehicle, code ZA5 or ZA	
2.2	Remove insulating element for rear door	On freezer vehicle or refrigerator vehicle, code ZA5 or ZA8	AR83.65-D-2260A
3	Disconnect connectors (7, 8) and expose cable.	On vehicles with central locking, code FZ0 or FZ1 i Installation: Observe routing of electric leads.	

4	Unscrew bolts (3) on door lock (5)	 Installation: Replace self-locking bolts (3).	
			000 589 01 10 00
			BA72.20-N-1006-01A
5	Remove door lock (5) from rear door		
6	Detach release cable (4) at door lock (5).		
7	Install in the reverse order		

 **Rear door**

Number	Designation	Models
BA72.20-N-1006-01A	Bolt for door lock on rear door	690.6, 901, 902, 903, 904
		Nm 10

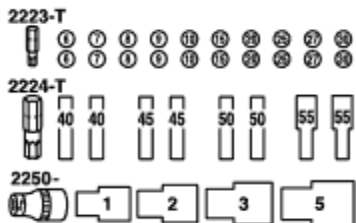

000 589 01 10 00

Torx bit set

AS86.61-Z-0002-01A	Risk of injury caused by exiting refrigerant and by contact with the components of the refrigerant system	Wear protective clothing, safety gloves and safety glasses	 Danger!
--------------------	--	--	---

Potential risks

Risk of injury caused by refrigerant exiting while working on the refrigerant system or by damage to components filled with refrigerant. Frostbite to body parts can be caused by refrigerant exiting out of the system. **Risk of suffocation** caused by refrigerants that are heavier than air. Frostbite can also be caused by skin contact with components that are supercooled.

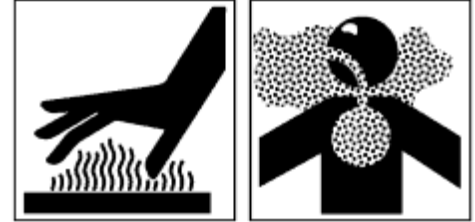

D00.00-1125-01

Safety instructions/precautions

- When working on components that are filled with refrigerant, make sure that the room receives sufficient ventilation.
- Wear protective clothing, safety gloves and safety glasses.
- Shut off the refrigerant system in a timely manner before starting repair work.
- Let components of the system reach room temperature.
- Heating of components of a closed refrigerant system is forbidden. Smoking, fires and open flames in the work area are also forbidden.
- Workshop personnel must demonstrate their knowledge in accordance with the OSHA requirements (Occupational Safety and Health Administration) and be able to act accordingly.
- All work involving assembly and disassembly and all leak tests must be performed as per the relevant regulations and requirements of the ANSI, NFPA and UL standards (e.g. UL No. 484)

Refrigerant in combination with open flames and hot surfaces can produce poisonous gasses. A fire hazard also exists for nonflammable refrigerants due to oils or insulating material present in the refrigerant fluid.

First aid measures

If frostbite occurs, place affected body part against another warm part of the body and cover with a sterile bandage if possible. Never warm up frostbitten body parts too fast (e.g. by placing in hot water). Do not touch, move, press on, or place stress on affected body parts.

If refrigerant is inhaled, move victim to fresh air, keep victim warm and calm and administer oxygen if necessary. Check for breathing. If there is no breathing or insufficient breathing, the preferable action is to perform mouth-to-mouth resuscitation. If necessary, carry out CPR.

If skin comes into contact with refrigerant, flush affected body part with water.

If eyes are affected immediately and thoroughly wash out eyes (making sure that eye lids are open) with plenty of clean water.

 If any of these symptoms occur, consult a physician immediately.

AR83.30-D-1000-01A	Disconnect roof air conditioning from the vehicle's line system		
⚠ Danger!	Risk of death caused by falling down from the roof of the vehicle. Risk of injury to other persons caused by falling objects during work in the area of the roof.	Work on or in the area of the vehicle's roof may only be performed on suitable equipment (ladders, scaffolds, lifting platforms). Sufficiently secure the area to be worked in.	AS65.00-Z-0002-01B
⚠ Danger!	Risk of injury caused by exiting refrigerant and by contact with the components of the refrigerant system	Wear protective clothing, safety gloves and safety glasses	AS86.61-Z-0002-01A

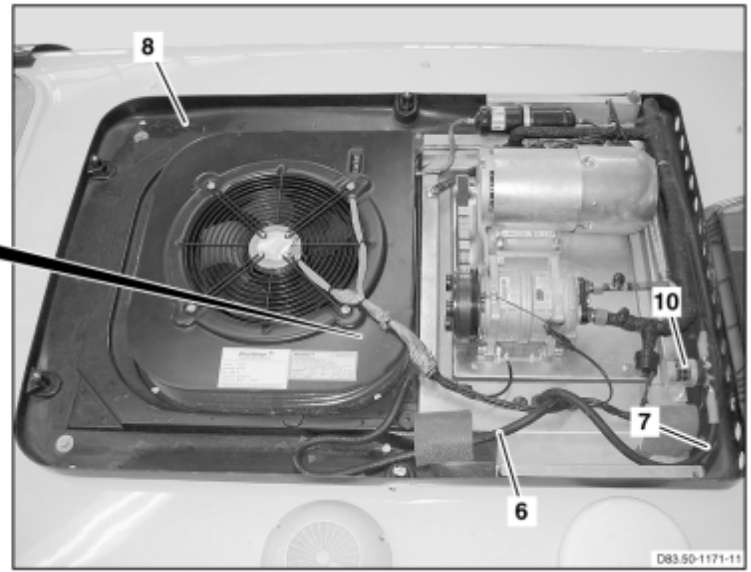
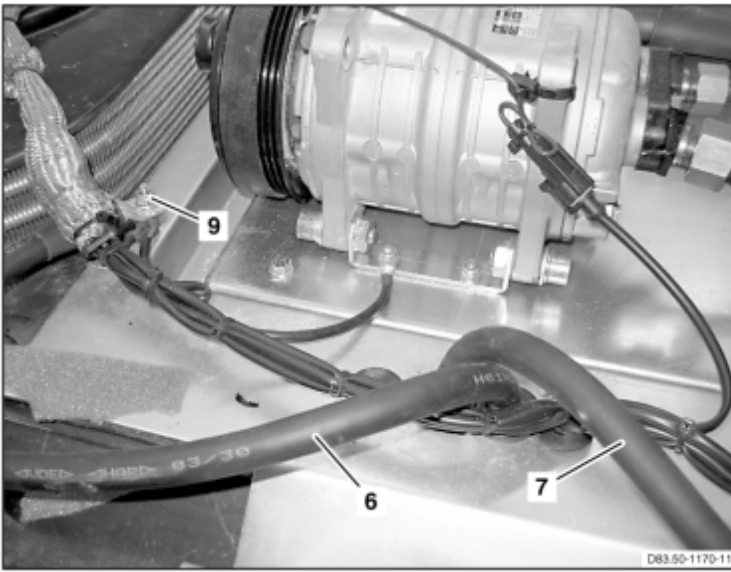

D83.50-1172-08

1 Remove foam pad from ground and positive leads (6, 7).

2 Unscrew nut for ground line (6) at ground point (9).

3 Detach ground line (6) from ground point (9).

4 Guide ground line (6) through the rubber grommet into the vehicle interior.

i Spray suitable sliding compound onto the rubber grommet to make it easier to guide through.

5 Unscrew nut of positive lead (7) at load relay (10).

6 Detach positive lead (7) from load relay (10).

7 Guide positive lead (7) through the rubber grommet into the vehicle interior.

i Spray suitable sliding compound onto the rubber grommet to make it easier to guide through.

AR83.30-D-1000-03A	Roof air conditioning - prepare installation location for bonding / sealing		
<p>⚠ Danger!</p>	<p>Risk of death caused by falling down from the roof of the vehicle. Risk of injury to other persons caused by falling objects during work in the area of the roof.</p>	<p>Work on or in the area of the vehicle's roof may only be performed on suitable equipment (ladders, scaffolds, lifting platforms). Sufficiently secure the area to be worked in.</p>	<p>AS65.00-Z-0002-01B</p>

1 Remove old rooflight sealing tape (1) from vehicle roof (2).

2.1 Remove old rooflight sealing tape (1) from roof air conditioning.

i Only when reinstalling the old roof air conditioning.

3 Clean sealing surfaces on vehicle roof (2) and on the roof air conditioning.

4 Apply new rooflight sealing tape (1) to vehicle roof.

i Note direction of installation. The ends of the new rooflight sealing tape (1) must overlap at the rear, when viewed in the direction of travel.

i Insert roof air conditioning into the vehicle roof (2) immediately after applying the new rooflight sealing tape (1).

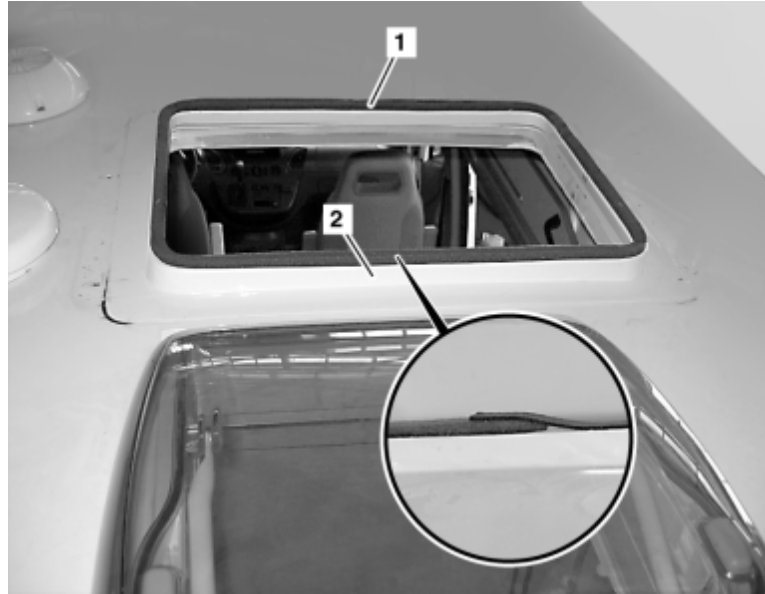

AR83.30-D-1000-05A	Connect roof air conditioning to the vehicle's line system		
⚠ Danger!	Risk of death caused by falling down from the roof of the vehicle. Risk of injury to other persons caused by falling objects during work in the area of the roof.	Work on or in the area of the vehicle's roof may only be performed on suitable equipment (ladders, scaffolds, lifting platforms). Sufficiently secure the area to be worked in.	AS65.00-Z-0002-01B
⚠ Danger!	Risk of injury caused by exiting refrigerant and by contact with the components of the refrigerant system	Wear protective clothing, safety gloves and safety glasses	AS86.61-Z-0002-01A

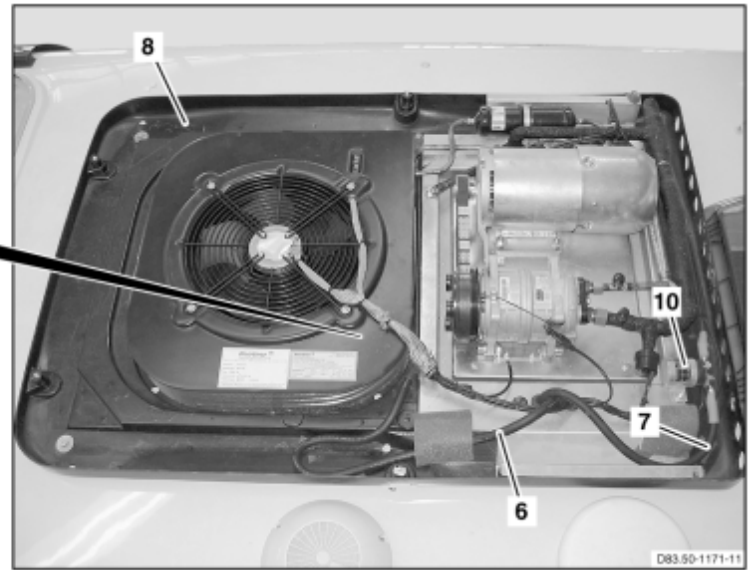
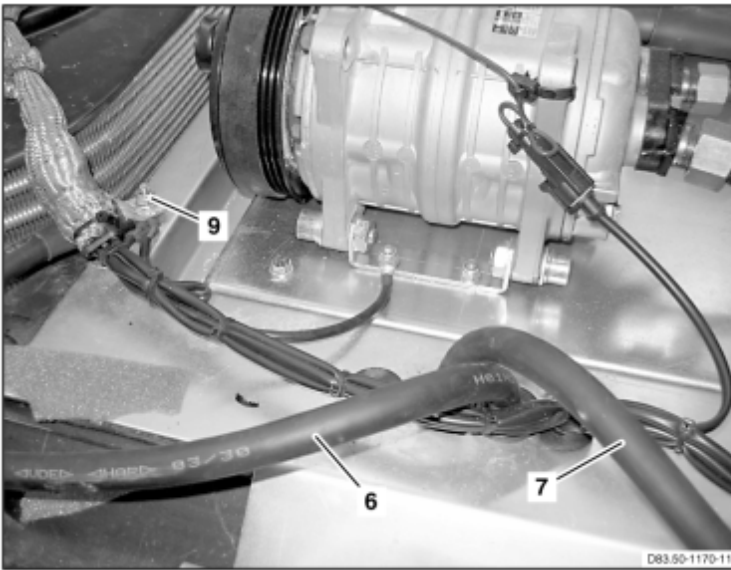

D83.50-1172-08

1 Guide positive lead (7) through the rubber grommet from the vehicle interior through the roof air conditioning (8) to the outside.

i Spray suitable sliding compound onto the rubber grommet to make it easier to guide through.

2 Connect positive lead (7) to load relay (10).

3 Screw nut of positive lead (7) onto load relay (10).

4 Guide ground line (6) through the rubber grommet from the vehicle interior through the roof air conditioning (8) to the outside.

i Spray suitable sliding compound onto the rubber grommet to make it easier to guide through.

5 Connect ground line (6) to ground point (9).

6 Screw nut for ground line (6) onto ground point (9).

7 Attach foam pad for ground and positive leads (6, 7).

AS83.00-Z-0001-01A	<p>Risk of explosion caused by welding or soldering work on closed air conditioning system.</p> <p>Risk of poisoning caused by inhaling overheated refrigerant vapors. Risk of injury to skin and eyes caused by contact with liquid refrigerant.</p>	<p>Never perform welding work on or near a closed air conditioning system. No smoking or open flames. Wear safety glasses and protective gloves. Work only in well ventilated areas. Carry out repair work on the air conditioning system circuit only after the system has been discharged.</p>	<p> Danger!</p>
--------------------	--	--	--

Potential risks

Risk of explosion

When closed air conditioning systems (charged or empty) become heated, high pressures are produced that can ultimately cause the system to burst. For this reason, all **welding and soldering operations** on or near closed air conditioning systems are prohibited.

High pressure levels can combine with refrigerant vapors to produce a mixture that is potentially explosive when exposed to atmospheric air.

Risk of poisoning

Refrigerant can decompose when overheated. The resulting substances are toxic and should never be inhaled.

- All refrigerant must be evacuated from the entire air conditioning system prior to doing any **repair work** on the air conditioning circuit or components.
- Because it poses a hazard to the atmosphere as well as to personal health and safety, discharging refrigerant directly into the air is prohibited.
- Suitable evacuation, treatment and charging devices equipped with integral disposal and treatment facilities must be used for evacuating refrigerant.
- Even after the system has been evacuated, residual pressure may still be present in the system when loosening couplings. Therefore, loosen the couplings carefully, so that the pressure can dissipate slowly.
- Avoid all contact with refrigerant in its liquid state.

Risk of injury

Refrigerant vapors are heavier than air; this means that escaping gases pose a risk of suffocation for anyone in a work pit beneath the vehicle. Contact with refrigerant in its liquid state may cause chilblain-like damage to the skin (due to undercooling).

Safety instructions/precautions

- All **welding, brazing and soldering operations** on sealed air conditioning systems and in their immediate vicinity are prohibited.
- Never smoke when working with refrigerant, never expose refrigerant to open flames.
- A **piercing odor** can indicate overheated refrigerant - never inhale these vapors. Leave closed rooms immediately and ventilate thoroughly.

First aid measures

In case of eye contact

- Immediately flush with plenty of running water and consult a physician.

In case of skin contact

- Consult a physician immediately in case of frostbite.

In case of inhalation

- of concentrated refrigerant, immediately take victim out into the fresh air and keep victim calm.
- If the victim's breathing is shallow, or the individual has stopped breathing altogether, tilt the head back and administer artificial resuscitation. Call a doctor.

In case of ingestion

- Consult a physician immediately.

- Always wear safety glasses and protective gloves when working with refrigerant.

AH83.30-N-0005-01C	Protect air conditioning circuit and components from moisture when carrying out repair work	Type 903.662	i
--------------------	---	--------------	---

The refrigerant R134a is colorless and odorless.

At normal temperatures it is neither toxic nor flammable, and will not explode in the air, no matter what its concentration.

The R134a refrigerant may only be used in air conditioning systems for which R134a has been specifically approved.

i The refrigerant R134a must not be mixed with other refrigerants (e.g. R12).

The refrigerant R134a does not contain any chlorofluorocarbons (CFC). In contrast to other refrigerants (e.g. R12) it is not hazardous to the environment at normal temperatures. The refrigerant R134a does not damage the earth's ozone layer.

Despite these benefits, the use of suitable equipment to discharge and process used gas and to recharge systems with new refrigerant R134a is absolutely mandatory; this equipment must include integral disposal and reprocessing capabilities.

AH83.30-N-0003-01B	Notes on handling refrigerant R134a	Type 903.662	i
--------------------	-------------------------------------	--------------	----------

The refrigerant R134a is colorless and odorless.

At normal temperatures it is neither toxic nor flammable, and will not explode in the air, no matter what its concentration.

The R134a refrigerant may only be used in air conditioning systems for which R134a has been specifically approved.

i The refrigerant R134a must not be mixed with other refrigerants (e.g. R12).

The refrigerant R134a does not contain any chlorofluorocarbons (CFC). In contrast to other refrigerants (e.g. R12) it is not hazardous to the environment at normal temperatures. The refrigerant R134a does not damage the earth's ozone layer.

Despite these benefits, the use of suitable equipment to discharge and process used gas and to recharge systems with new refrigerant R134a is absolutely mandatory; this equipment must include integral disposal and reprocessing capabilities.

BB00.40-P-0361-00A	Refrigerants	<p>⚠ Read Use and handling of halogenated refrigerants! (Regulation in FR Germany)</p> <p>Quality R 134 a: Passenger vehicles, vans, UNIMOG, MB-trac, commercial vehicles</p> <p>i Note R 134 a label on the filling plate of the air conditioning system and thread type of Schrader valve!</p>	Sheet 361.0
--------------------	--------------	---	-------------

⚠ Use and handling of halogenated refrigerants (Regulation in FR Germany)

a) It is **prohibited**, when operating, repairing and taking air conditioning systems out of operation, to allow refrigerants R12 and R 22, contrary to the state of the art, to escape **into the atmosphere**.

b) The amounts used during operation and maintenance must be **recorded** and, on request, these documents must be presented to the competent authority.



i **R 134 a** may only be filled into the intended air conditioning systems. Passenger vehicle models as of year of construction 1984 (incl. MODEL 201) with A/C compressor 10 P and 10 PA, which have previously been operated with refrigerant R 12, can be converted to refrigerant R 134 a (read conversion instructions SI Group 83/81 dated 15. 2. 94).

c) Maintaining air conditioning systems and taking them out of operation as well as the taking back of R 12 and R 22 may only be carried out by persons who have the required expertise and technical equipment.

d) Take-back obligation for refrigerants R 12 and R 22
Distributors of R 12 and R 22 must take them back after use (as of Nov. 91). Records must be made and kept for 3 years regarding the take-back.

Before topping up the refrigerant, always look on the major assembly to determine which air conditioning is fitted. R 134 a systems have green marks, a "R 134 A" plate is also provided on the compressor.

<p>Mercedes-Benz refrigerant a, A 000 989 03 48 10</p> <p>i Observe R 134 a!</p>	DaimlerChrysler AG, Stuttgart, Germany
--	--

BB00.40-P-0362-00A	Compressor oils	<p> Product approval dependent on A/C compressor and refrigerant</p> <p> Passenger vehicles: with the conversion of the air conditioning systems in passenger vehicle models as of year of construction 1984 (incl. Model 201) with AC compressor 10 P and 10 PA from refrigerant 12 to R 134 a, the refrigerant machine oil must also be changed. The converted R 134 a air conditioning systems may only be filled with the PAG oil of part no. 001 989 0803!</p>	Sheet 362.0
--------------------	-----------------	--	-------------

Passenger vehicles and commercial vehicles A/C compressor for R 12 /R 22 air conditioning systems

Caltex Capella WF 100	Caltex (UK) Limited, London, England
Capella WF 100	Texaco Technology Ghent, Ghent, Belgium
Shell Clavus Oel G 100	Deutsche Shell AG, Hamburg, Germany
Suniso 5 GS	Sun Company, Inc., Philadelphia, PA, USA

Passenger vehicles A/C compressor for R 134 a air conditioning systems

MB 362.0 Kompressorenöl A 001 989 08 03	DaimlerChrysler AG, Stuttgart, Germany
---	--

Bock compressors

MB 362.0 Kompressorenöl A 001 989 16 03	DaimlerChrysler AG, Stuttgart, Germany
Triton SE 55	DEA Mineraloel AG, Hamburg, Germany

AS00.00-Z-0010-01A	Risk of death caused by vehicle slipping or toppling off of the lifting platform.	Align vehicle between the columns of the lifting platform and position the four support plates below the support points specified by the vehicle manufacturer.	 Danger!
--------------------	--	--	---

RISK OF ACCIDENT AND INJURY

Please make sure that:

- The vehicle is centered lengthwise and crosswise between the lifting platform columns.
- The support plates on the lifting platform support points are all positioned at the same height.
- The vehicle is first be raised a few inches (wheels are still touching the ground) and the position and fit of the support plates and lift points are checked before raising the vehicle to the full lifted position.
- The vehicle is not raise off the lifting platform plates when components are being supported.

If the arms of the lifting platform and/or the support plates are not positioned properly, or if components of the vehicle are supported so that the vehicle raises off the platform, then the vehicle can **slip** off the platform and cause **life-threatening** injuries to you and/or other people.

Before removing axles and assemblies from the vehicle, make sure the vehicle is secured to the platform or that sand bags are used to balance the vehicle out.

Otherwise the vehicle could **tip** because of the uneven distribution of weight. This could cause **life-threatening** injuries to you and/or other people.

Note: In Germany, lift platform operators must observe the following regulations and guidelines: "Berufsgenossenschaftsvorschrift (BGV) D29 für Hebebühnen" and the guidelines issued by the lift platform manufacturer. In other countries, operators must comply with all relevant statutory and accident prevention regulations.

AS47.00-Z-0001-01A	Risk of explosion caused by fuel igniting, risk of poisoning caused by inhaling and swallowing fuel as well as risk of injury to eyes and skin caused by contact with fuel.	No fire, sparks, open flames or smoking. Pour fuels only into suitable and appropriately marked containers. Wear protective clothing when handling fuel.	 Danger!
--------------------	--	--	---

Potential risks

Risk of explosion, poisoning and injury

Fuels are highly inflammable and toxic if inhaled. Fuel may cause damage to skin. For example, skin is degreased when it comes into contact with gasoline fuel. Fuel vapors are explosive, invisible and spread out at floor level. This vapor is poisonous when inhaled and has an anesthetizing effect in high concentrations.

Safety precautions/instructions

- Observe the national safety precautions and regulations.
- No fire, sparks, open flames or smoking.
- Ensure the work place is adequately ventilated.
- Never drain or pour in fuels over assembly pits.

- Store drained fuel in a suitable and sealed vessel.
- Immediately eliminate any fuel which has flowed out.

Conducting work on a vehicle with open flames (e.g. welding etc.)

- Before carrying out this work, remove relevant parts of fuel system and seal open fuel lines with plugs.

First aid measures

- Clean affected skin areas with water and soap.
- Change affected clothing as quickly as possible.
- If fuel gets into the eyes, rinse eyes with water immediately and call a doctor if necessary.

AS83.70-Z-0002-01A	Risk of explosion caused by fuel vapors igniting, risk of poisoning caused by inhaling combustible gases and risk of injury caused by burns during and after operation of heater unit	Do not operate stationary heater, auxiliary heater or engine with heater booster in closed areas or when refueling. Allow heater unit to cool down after operation and wear protective gloves.	 Danger!
--------------------	--	--	---

Potential risks

Risk of explosion

caused by heater while fueling.

Risk of poisoning

Gases that occur during the combustion process in the heater are a health hazard and, where the heater is operated in enclosed premises, e.g. workshops or garages, may induce symptoms of toxication, which could lead to unconsciousness.

Danger of burns

Heater housing and exhaust gas outlet can cause severe burns during or following operation.

Safety instructions/precautions

- Never operate engine with heater booster in closed rooms.
- The stationary or auxiliary heater must not be started up nor operated at filling stations or in the vicinity of refueling systems because of the danger of an explosion being caused by fuel vapor.
- When performing function test or checking emission levels, operate heater only in rooms with suitable exhaust gas extraction system for engine and heater.
- When working on heater, allow it to cool down or wear protective gloves.

AS00.00-Z-0026-01A	Risk of injury to skin and eyes from handling hot or glowing objects. Risk of fire caused by contact of glowing objects with flammable materials.	Wear safety gloves, protective clothing and safety glasses, if necessary. Avoid contact between glowing objects and flammable materials.	 Danger!
--------------------	---	--	---

Potential risks

Risk of injury

Contact with hot or glowing objects without suitable protective clothing can cause severe burns to the skin and eyes.

 **Risk of fire** when glowing objects come into contact with flammable materials.

When glowing objects come into contact with water, they produce hot steam or cause the water to splash, which can cause serious burns to skin or eyes.



D00.00-1117-01

Safety precautions/instructions

- Protective clothing, goggles, and protective gloves must always be worn.
- If possible, first let the glowing object cool off to room temperature. If this is not possible, transport the glowing object using equipment that is specially made for this purpose only.
- Avoid sparks and contact with flammable materials when handling glowing objects.
- Workshop personnel must demonstrate their knowledge in accordance with the OSHA requirements (Occupational Safety and Health Administration) and be able to act accordingly.

First aid measures

Treat burns by placing the affected area under cold running water for at least 15 min. Cover the affected area with a sterile Metalline burn compress. Apply the Metalline coated side to the burn and wrap loosely with a gauze bandage or a triangular bandage. The burn compress will not stick to the wound, is heat insulating and protects the wound from contamination.

 If injuries are serious, consult a physician immediately.

AS86.00-Z-0003-01A	<p>Risk of explosion caused by the ignition of methane gas exiting from components of the black water system and gray water system. Risk of injury caused by burns to the skin and eyes and by the inhalation of methane gas or by skin contact with feces.</p>	<p>Wear protective respiratory masks, protective gloves and safety glasses. Before commencing any work, ensure that all sources of ignition have been removed and the black water system has been completely emptied.</p>	<p> Danger!</p>
--------------------	---	---	--

Potential risks

Risk of explosion

Methane gas is produced by decomposing organic matter in a sealed environment. Methane gas can ignite. Accidental ignition can cause an explosion.



Risk of injury

Accidental ignition of methane gas can cause burns to skin and eyes and can cause injuries due to the forces of the explosion. Nausea and vomiting can occur from inhaling methane gas. Feces can cause skin irritations.

D00.00-1124-01

Safety precautions/instructions

Before commencing any work, ensure that all sources of ignition have been removed.

- Before commencing with any repair work on the black and gray water systems, first empty and clean both systems as per the legal requirements.
- No open flames or smoking in the work area.
- Avoid the formation of sparks (use spark-inhibiting tools).
- Keep fire extinguishing devices at hand.
- Wear protective respiratory masks, protective gloves and safety glasses.
- Ensure that the place where repairs are made is adequately ventilated.
- Workshop personnel must demonstrate their knowledge in accordance with the OSHA requirements (Occupational Safety and Health Administration) and be able to act accordingly.
- All work involving assembly and disassembly and all leak tests must be performed as per the relevant regulations and requirements of the ANSI and NFPA standards.

First aid measures:

Move the victim out of the risk area.

If eyes or skin come into contact with the feces, thoroughly and immediately wash with generous amounts of water. For eyes, make sure eyelids are open the entire time.

Treat burns by placing the affected area under cold running water for at least 15 min. Cover the affected area with a sterile Metalline burn compress. Apply the Metalline coated side to the burn and wrap loosely with a gauze bandage or a triangular bandage. The burn compress will not stick to the wound, is heat insulating and protects the wound from contamination.

If inhaled, and if nausea, headaches, visual problems or irritation of the eyes, nose and throat occur, remove victim to fresh air. Place unconscious victims in the recovery position and check for breathing and pulse. If there is no breathing or insufficient breathing, the preferable action is to perform mouth-to-mouth resuscitation. If necessary, carry out CPR.

 If injuries are serious, consult a physician immediately.

AS86.00-Z-0004-01A	Risk of explosion caused by ignition of gas exiting the lines of the vehicle's gas system. Risk of injury caused by burns to skin and eyes.	Before commencing any work, ensure that all sources of ignition have been removed and that the gas system is completely emptied if necessary. Wear protective clothing.	 Danger!
--------------------	---	---	---

Potential risks

Risk of explosion

If the vehicle's gas system leaks, there is the chance that the gas may accidentally ignite in the vehicle or in closed rooms, causing an explosion.

Risk of injury

Accidental ignition of the exiting gas can cause burns to skin and eyes.



D00.00-1132-01

Safety precautions/instructions

It must be ensured that all sources of ignition are removed from the area before commencing work.

- Before commencing with any repair work on the gas tank, it must be completely emptied as per the legal requirements.
- Before commencing any work on the lines of the gas system, all shutoff valves must be closed as per the legal requirements.
- No open flames or smoking in the work area.
- Avoid the formation of sparks (use spark-inhibiting tools).
- Keep all combustible materials and objects away from equipment
- Do not use any flammable substances to lubricate threads and valves (oils, grease, etc.).
- Wear protective clothing, safety gloves and safety glasses

- Keep fire extinguishing devices at hand.
- Perform a fire check of the surroundings after work has carried out.
- Never perform work in closed rooms.
- All work involving assembly and disassembly and all leak tests may only be performed by authorized personnel.
- Workshop personnel must demonstrate their knowledge in accordance with the OSHA requirements (Occupational Safety and Health Administration) and be able to act accordingly.
- All work involving assembly and disassembly and all leak tests must be performed as per the relevant regulations and requirements of the ANSI, NFPA and UL standards (e.g. UL No. 1075 and NFPA No. 58)

Due to the fact that explosions can occur when the gas system leaks, a leak test must be performed before restarting the system after repairs have been done in which the pipes and lines of the gas system have been opened.

First aid measures:

Move the victim out of the risk area.

If eyes are affected immediately and thoroughly wash out eyes (making sure that eye lids are open) with plenty of clean water.

If skin is affected drench with water. The victim should remain calm and be kept warm.

If inhaled, and if drowsiness, headaches, visual problems or irritation of the eyes, nose and throat occur, remove victim to fresh air. Place unconscious victims in the recovery position and check for breathing and pulse. If there is no breathing or insufficient breathing, the preferable action is to perform mouth-to-mouth resuscitation. If necessary, carry out CPR.

i If any of these symptoms occur, consult a physician immediately.

AR86.30-D-0065-01A

Check fresh water system for leakage in area of boiler/sink combination

1 Check water tap of boiler/sink combination (1) for leakage

2 Check hose connection on water tap of boiler/sink combination (1) for leakage

3 Check hose connections on rear distributor element of boiler/sink combination (1) for leakage.

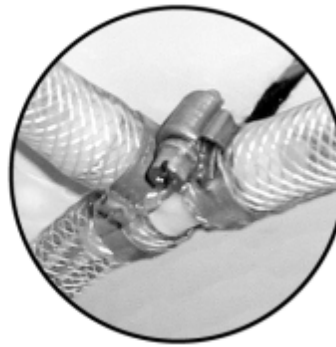
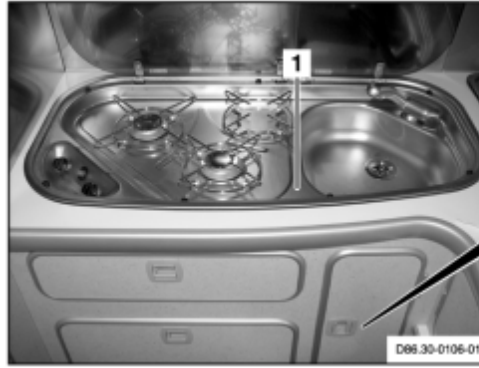

D86.30-0108-06

AR86.30-D-0065-02A

Check fresh water system for leakage in area of fresh water tank

1 Check hose connection on fresh water tank (2) for leakage.

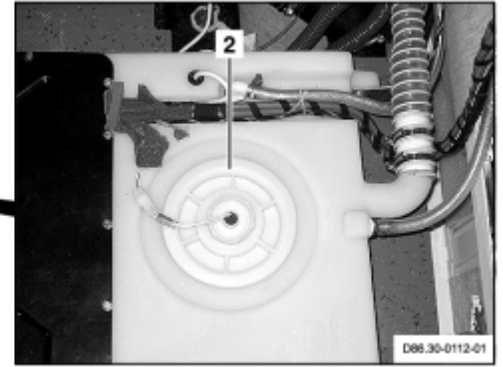
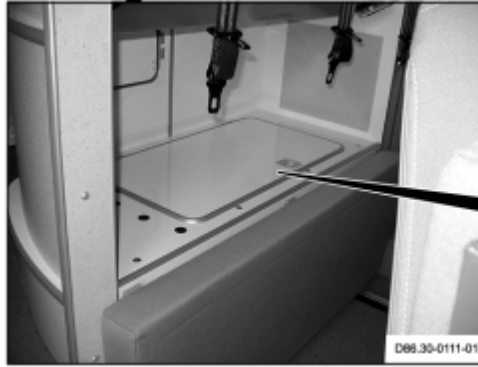

D86.30-0113-06

AR86.30-D-0065-03A

Check fresh water system for leakage in area of wash room

1 Check hose connections on water tap (3) in wash room for leakage.

2 Check water tap (3) in wash room for leakage.

3 Check hose connection on toilet (4) for leakage.

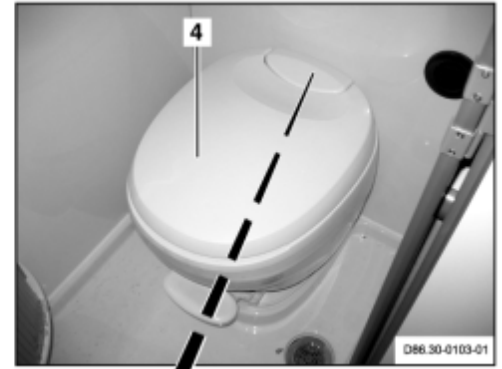

D86.30-0105-06

AR86.30-D-0065-04A

Check fresh water system for leakage in rear area of vehicle

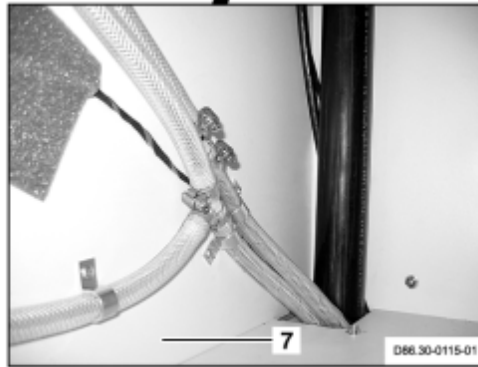
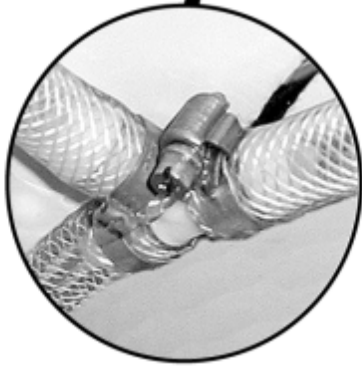
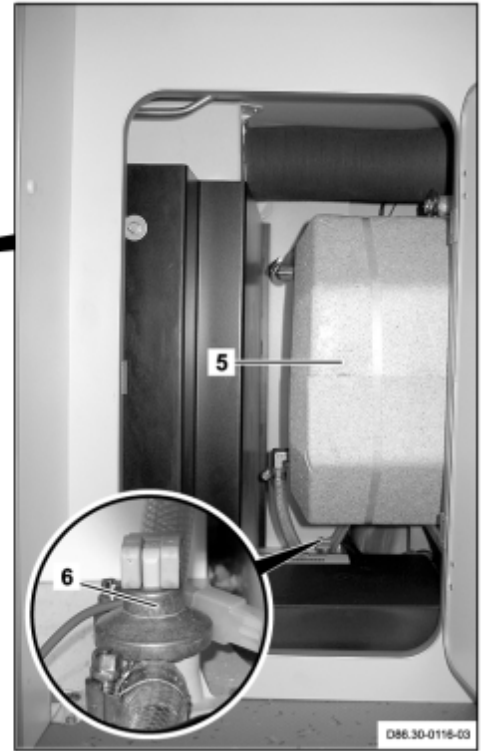
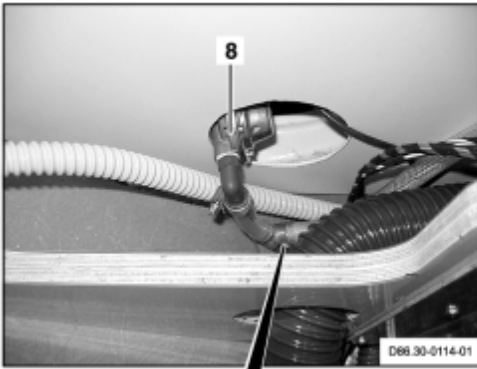

D86.30-0117-09

1 Check hose connections on hot water boiler (5) for leakage.

2 Check hose connections on system drain valve (6) for leakage.

3 Check hose connections on distributor element in wardrobe (7) for leakage.

4 Check pressure reducing valve (8) on city water connecting pipes for leakage.

5 Check hose connection on pressure reducing valve (8) for leakage.

6 Check hose connections on distributor element behind pressure reducing valve (8) for leakage.

AR86.60-D-0009-01A

Prepare wash basin and shower tray for installation

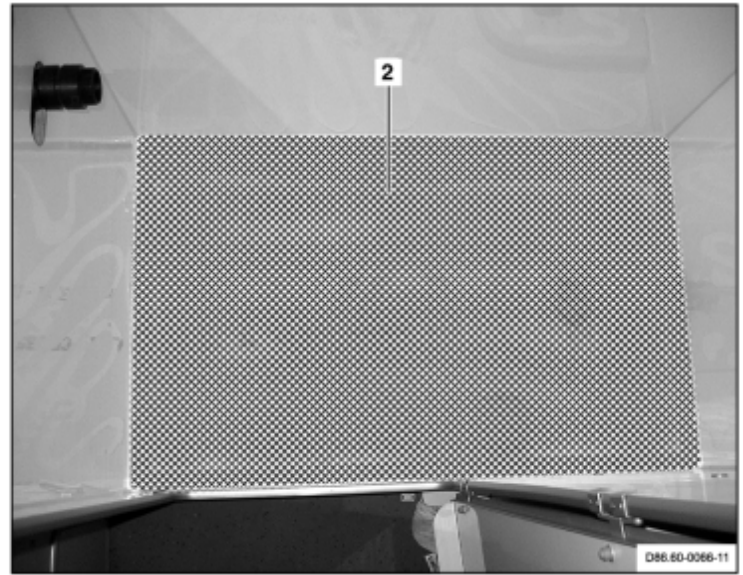
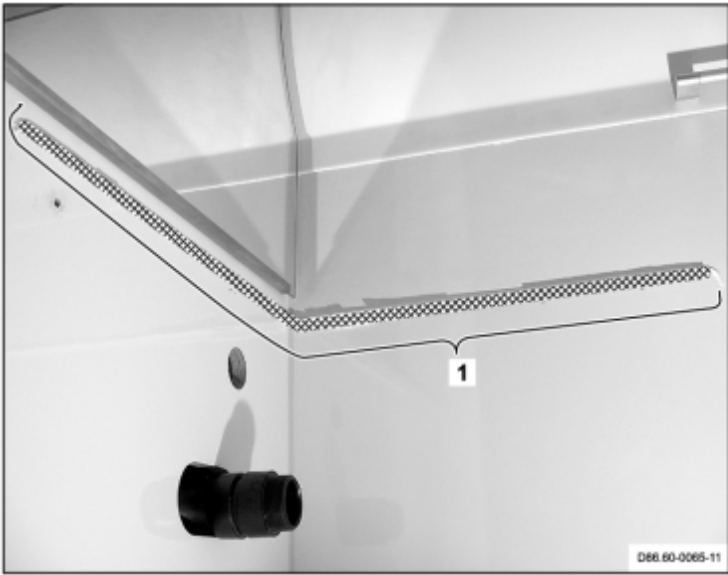

D86.60-0067-08

1 Area

1 Remove sealant from wash basin in marked area (1)

2 Degrease marked area (1) with suitable cleaner

3.1 Remove glue from shower tray in marked area (2)

2 Area

i Perform work only when shower tray is installed

4.1 Degrease marked area (2) with suitable cleaner

i Perform work only when shower tray is installed

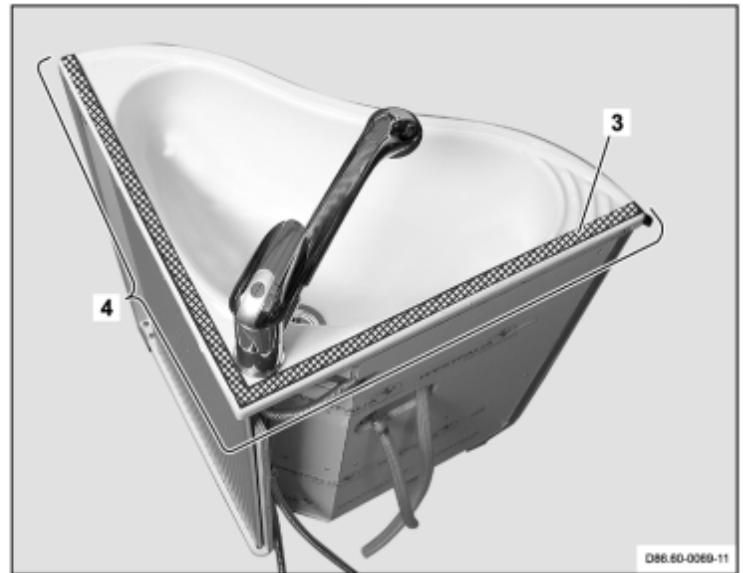
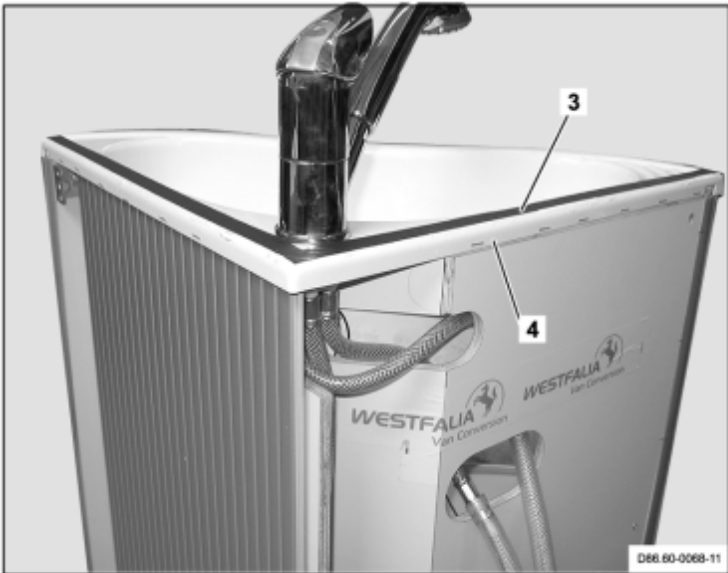

D86.60-0070-08

Shown on wash basin

3 Adhesive tape

4 Area

5 Mask area (4) on top of wash basin with masking

tape (3)

6 Slightly roughen gluing surface in area (4) with sand paper

7 Degrease gluing surface in area (4) with suitable cleaner.

Shown on shower tray

5 Adhesive tape

6 Area

9.1 Mask area (6) on top with adhesive tape (5)

i Perform work only when shower tray is installed

10.1 Roughen gluing surface in area (6) with suitable sand paper

i Perform work only when shower tray is installed

11.1 Degrease gluing surface in area (6) with suitable cleaner

! Allow cleaner to air-dry cleaner according to manufacturer's specifications, to prevent poor adhesion

8 Apply suitable primer to gluing surface in area (4)

! Allow cleaner to air-dry cleaner according to manufacturer's specifications, to prevent poor adhesion

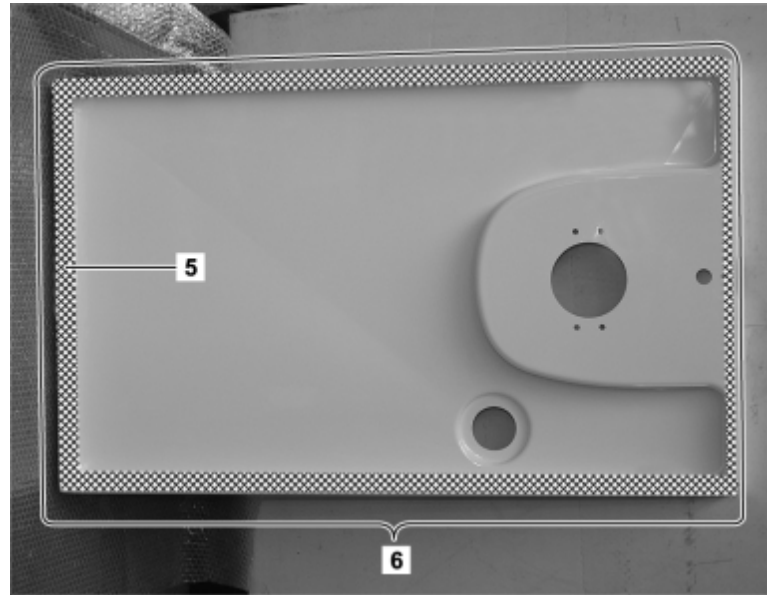

D86.60-0071-11

! Allow cleaner to air-dry cleaner according to manufacturer's specifications, to prevent poor adhesion

i Perform work only when shower tray is installed

12.1 Apply suitable primer to gluing surface in area (6)

! Allow cleaner to air-dry cleaner according to manufacturer's specifications, to prevent poor adhesion

i Perform work only when shower tray is installed

AR86.60-D-0051-02A

Detach hanging cabinet, fasten

1 Remove upper rubber profile (1) from hanging cabinet in longitudinal direction.

i Only in repair area (see marking).

i **Fastening:** Glue in rubber channel (1) again.



D86.60-0034-01

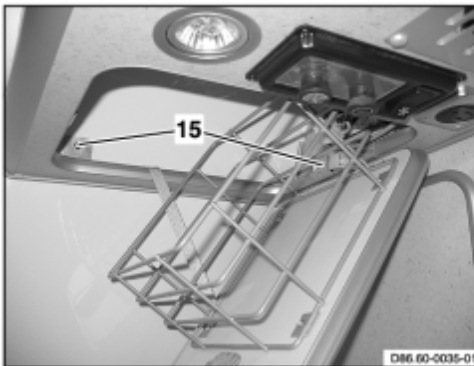

D86.60-0035-01

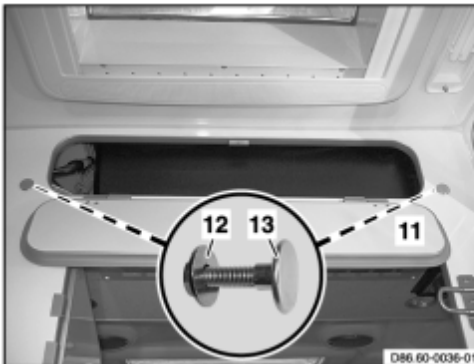

D86.60-0036-01

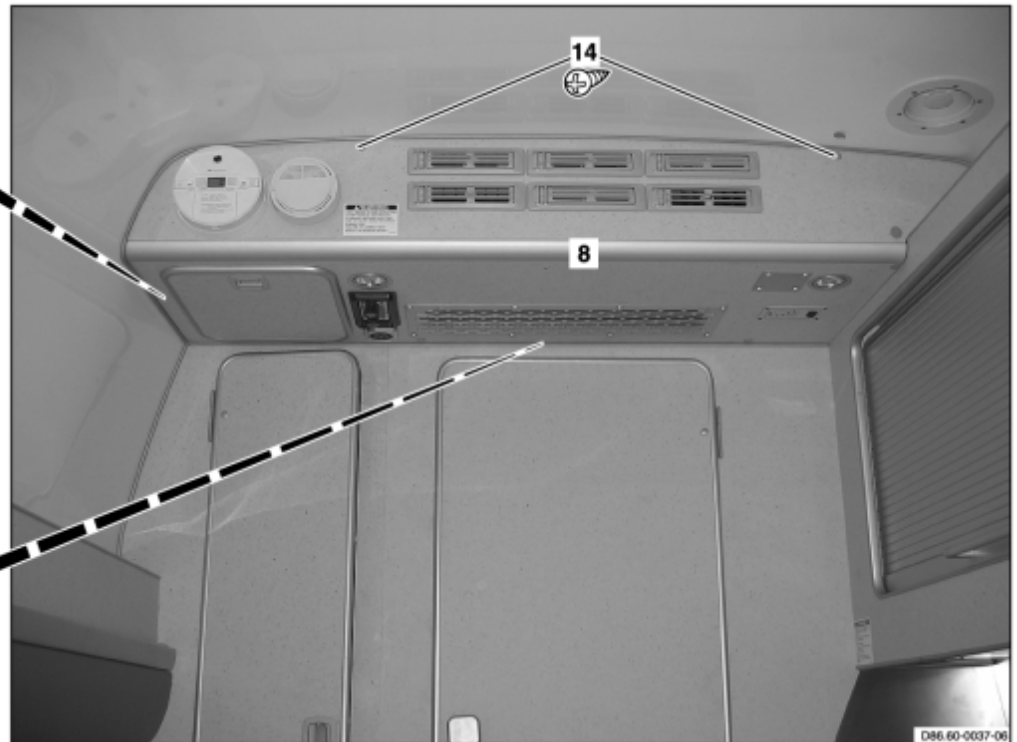

D86.60-0037-08

D86.60-0038-09

2 Open assembly flap (11) above sanitary block door.

3 Unscrew bolts (13) from lateral hanging cabinet mount (8)

4 Remove counter nuts (13) from dividing wall.

5 Remove bolt caps (14).

8 Slightly lower lateral hanging cabinet (8) on right.

i Helper required.

6 Unscrew bolts (14).

7 Unscrew right bolts (15) in lateral hanging cabinet (8).

i Helper required.

 Lower only until sufficient space is ensured for electrical lines in lateral hanging cabinet (8) and ensure that the electrical leads are not stretched (danger of damaging electrical lines).

9 Fasten in opposite order.





D86.60-0039-01

AR91.21-D-4040-01B	Adjust rear sliding block at bench seat		
 Danger!	Risk of injury caused by body parts becoming jammed, pinched or severed by doors, covers, flaps or by loose components	Keep body parts well clear when moving doors, covers, flaps and components. Wear protective gloves and protective shoes.	AS00.00-Z-0025-01A



Nm Rear seats

Number	Designation		Nm	Model 903.662 with code ZU8, Z29
BA91.12-N-1010-03A	Bolt, rear sliding block bracket to seat bench		Nm	39
BA91.12-N-1011-03A	Nut, sliding block to bench seat		Nm	20

1 Insert bench seat into C-rails and slide.

 If the bench seat moves easily, tighten the bolts for the rear sliding block bracket at the bench seat , then tighten front and rear nuts for both sliding blocks at bench seat .

2 Remove bench seat out of C-rails.

 In order to tighten middle nuts for sliding block at bench seat .

3 Reinstall bench seat.

MODELSXD1, XD2, XD3, XD4, XD5, XD6, XD7, YD1, YD2, YD3, YD4, YD5, YD6, YD7, WD1, WD2, WD3, WD6, WD7

MODELS903.61 /66 /67, 904.61 /66

with CODE (SA5) Driver airbag

with CODE (SA6) Co-driver's airbag

with CODE (ZU7) National version for Canada

MODELS903.61 /66 /67, 904.61 /66

with CODE (SA5) Driver airbag

with CODE (SA6) Co-driver's airbag

with CODE (ZU8) National version for USA

MODELS903.61 /62 /66 /67, 904.61 /62 /66

with CODE (SA5) Driver airbag

with CODE (SA6) Co-driver's airbag

with CODE (ZU9) National version for Mexico

PE91.00-D-2000-99D	Wiring diagram of airbag (AB), emergency tensioning retractor (ETR)		PE91.00-D-2000-99D
PE91.00-D-2000-60D	Legend of wiring diagram of airbag (AB), emergency tensioning retractor (ETR)		PE91.00-D-2000-60D
OV00.01-N-1901-03D	Use of wiring diagrams		OV00.01-N-1901-03D
OV00.01-N-1901E	Search aid for all wiring diagram groups		OV00.01-N-1901E
OV00.01-N-1001-27E	Abbreviations for wiring diagrams		OV00.01-N-1001-27E
GF00.19-D-2000D	Arrangement and assignment of ground points		GF00.19-D-2000D
GF00.19-D-3100-49C	Arrangement and assignment of terminal blocks of airbag (AB), emergency tensioning retractor (ETR)		GF00.19-D-3100-49C
PE54.00-D-1100D	Overview of wiring diagrams for electrical system, equipment and instruments	Further wiring diagrams	PE54.00-D-1100D

MODELXD1##, XD2##, XD3##, XD4##, XD5##, XD6##, XD7##, YD1##, YD2##, YD3##, YD4##, YD5##, YD6##, YD7##, WD1##, WD2##, WD3##, WD6##, WD7## ### up to 649051 up to 31.3.04
 MODEL903.61# /66# /67#, 904.61# /66# ## up to 649051 up to 31.3.04

with CODE (E58) Electrical system for trailer socket

with CODE (ZU7) National version for Canada

MODEL903.61# /66# /67#, 904.61# /66# ## up to 649051 up to 31.3.04

with CODE (E58) Electrical system for trailer socket

with CODE (ZU8) National version for USA

MODEL903.61# /62# /66# /67#, 904.61# /62# /66# ## up to 649051 up to 31.3.04

with CODE (E58) Electrical system for trailer socket

with CODE (ZU9) National version for Mexico

PE31.19-D-2000-99G	Wiring diagram of trailer coupling		PE31.19-D-2000-99G
PE31.19-D-2000-60G	Legend for wiring diagram of trailer coupling		PE31.19-D-2000-60G
OV00.01-N-1901-03D	Use of wiring diagrams		OV00.01-N-1901-03D
OV00.01-N-1901E	Search aid for all wiring diagram groups		OV00.01-N-1901E
OV00.01-N-1001-27E	Abbreviations for wiring diagrams		OV00.01-N-1001-27E
GF00.19-D-2000D	Arrangement and assignment of ground points		GF00.19-D-2000D
GF00.19-D-3100-19C	Arrangement and assignment of terminal block connectors trailer coupling		GF00.19-D-3100-19C

PE31.19-D-2000H	Wiring diagram trailer hitch	21.4.04
------------------------	-------------------------------------	----------------

MODELXD1##, XD2##, XD3##, XD4##, XD5##, XD6##, XD7##, YD1##, YD2##, YD3##, YD4##, YD5##, YD6##, YD7##, WD1##, WD2##, WD3##, WD6##, WD7## ### as of 649052 as of 1.4.04
MODEL903.61# /66# /67#, 904.61# /66# ## as of 649052 as of 1.4.04

with CODE (E58) Electrical system for trailer socket

with CODE (ZU7) National version for Canada

MODEL903.61# /66# /67#, 904.61# /66# ## as of 649052 as of 1.4.04

with CODE (E58) Electrical system for trailer socket

with CODE (ZU8) National version for USA

MODEL903.61# /62# /66# /67#, 904.61# /62# /66# ## as of 649052 as of 1.4.04

with CODE (E58) Electrical system for trailer socket

with CODE (ZU9) National version for Mexico

PE31.19-D-2000-99H	Wiring diagram trailer hitch		PE31.19-D-2000-99H
PE31.19-D-2000-60H	Legend for wiring diagram of trailer coupling		PE31.19-D-2000-60H
OV00.01-N-1901-03D	Use of wiring diagrams		OV00.01-N-1901-03D
OV00.01-N-1901E	Search aid for all wiring diagram groups		OV00.01-N-1901E
OV00.01-N-1001-27E	Abbreviations for wiring diagrams		OV00.01-N-1001-27E
GF00.19-D-2000D	Arrangement and assignment of ground points		GF00.19-D-2000D
GF00.19-D-3100-19C	Arrangement and assignment of terminal block connectors trailer coupling		GF00.19-D-3100-19C

PE42.30-D-2200B	Wiring diagram antilock brake system (ABS/ acceleration slip regulation (ASR)	19.2.01
------------------------	--	----------------

MODELS XD1, XD2, XD3, XD6, XD7, YD1, YD2, YD3, YD6, YD7, WD1, WD2, WD3, WD6, WD7

MODEL 903.61 /66 /67

with CODE (BB0) Brake system antilock brake system ABS

with CODE (ZU7) National version for Canada

MODEL 903.61 /66 /67

with CODE (BB0) Brake system antilock brake system ABS

with CODE (ZU8) National version for USA

MODELS 903.61 /62 /66 /67

with CODE (BB0) Brake system antilock brake system ABS

with CODE (ZU9) National version for Mexico

PE42.30-D-2200-99B	Wiring diagram antilock brake system (ABS/ acceleration slip regulation (ASR)		PE42.30-D-2200-99B
PE42.30-D-2200-60B	Legend of wiring diagram anti-lock brake system (ABS)/ acceleration slip regulation (ASR)		PE42.30-D-2200-60B
OV00.01-N-1901-03D	Use of wiring diagrams		OV00.01-N-1901-03D
OV00.01-N-1901E	Search aid for all wiring diagram groups		OV00.01-N-1901E
OV00.01-N-1001-27E	Abbreviations for wiring diagrams		OV00.01-N-1001-27E
GF00.19-D-2000D	Arrangement and assignment of ground points		GF00.19-D-2000D
GF00.19-D-3100-61B	Arrangement and assignment of terminal block connectors anti-lock brake system (ABS)/acceleration slip regulation (ASR)		GF00.19-D-3100-61B
PE00.19-D-1100D	Survey of wiring diagrams covering all function groups	Further wiring diagrams	PE00.19-D-1100D
PE54.00-D-1100D	Overview of wiring diagrams for electrical system, equipment and instruments	Further wiring diagrams	PE54.00-D-1100D

PE42.30-D-2200C	Wiring diagram antilock brake system (ABS/ acceleration slip regulation (ASR)	19.2.01
------------------------	--	----------------

MODELS XD4, XD5, YD4, YD5

MODEL 904.61 /66

with CODE (BB0) Brake system antilock brake system ABS

with CODE (ZU7) National version for Canada

MODEL 904.61 /66

with CODE (BB0) Brake system antilock brake system ABS

with CODE (ZU8) National version for USA

MODEL 904.61 /62 /66

with CODE (BB0) Brake system antilock brake system ABS

with CODE (ZU9) National version for Mexico

PE42.30-D-2200-99C	Wiring diagram antilock brake system (ABS/ acceleration slip regulation (ASR)		PE42.30-D-2200-99C
PE42.30-D-2200-60C	Legend of wiring diagram anti-lock brake system (ABS)/ acceleration slip regulation (ASR)		PE42.30-D-2200-60C
OV00.01-N-1901-03D	Use of wiring diagrams		OV00.01-N-1901-03D
OV00.01-N-1901E	Search aid for all wiring diagram groups		OV00.01-N-1901E
OV00.01-N-1001-27E	Abbreviations for wiring diagrams		OV00.01-N-1001-27E
GF00.19-D-2000D	Arrangement and assignment of ground points		GF00.19-D-2000D
GF00.19-D-3100-61B	Arrangement and assignment of terminal block connectors anti-lock brake system (ABS)/acceleration slip regulation (ASR)		GF00.19-D-3100-61B
PE00.19-D-1100D	Survey of wiring diagrams covering all function groups	Further wiring diagrams	PE00.19-D-1100D
PE54.00-D-1100D	Overview of wiring diagrams for electrical system, equipment and instruments	Further wiring diagrams	PE54.00-D-1100D

TRANSMISSION722.681 in MODEL XD1, XD2, XD3, XD4, XD5, XD6, XD7, YD1, YD2, YD3, YD4, YD5, YD6, YD7, WD1, WD2, WD3, WD6, WD7

with CODE (G40) Automatic transmission

with CODE (M54) RPM increase with constant speed control

TRANSMISSION722.681 in MODEL 903.61 /66 /67, 904.61 /66

with CODE (G40) Automatic transmission

with CODE (M54) RPM increase with constant speed control

with CODE (ZU7) National version for Canada

TRANSMISSION722.681 in MODEL 903.61 /66 /67, 904.61 /66

with CODE (G40) Automatic transmission

with CODE (M54) RPM increase with constant speed control

with CODE (ZU8) National version for USA

PE27.45-D-2000-99A	Wiring diagram for working speed control (ADR)		PE27.45-D-2000-99A
PE27.45-D-2000-60A	Legend of wiring diagram of working speed control (ADR)		PE27.45-D-2000-60A
OV00.01-N-1901-03D	Use of wiring diagrams		OV00.01-N-1901-03D
OV00.01-N-1901E	Search aid for all wiring diagram groups		OV00.01-N-1901E
OV00.01-N-1001-27E	Abbreviations for wiring diagrams		OV00.01-N-1001-27E
GF00.19-D-2000D	Arrangement and assignment of ground points		GF00.19-D-2000D
PE00.19-D-1100D	Survey of wiring diagrams covering all function groups	Further wiring diagrams	PE00.19-D-1100D

PE82.10-D-2000E	Wiring diagram of exterior lights	19.2.01
------------------------	--	----------------

MODELSXD1, XD2, XD3, XD4, XD5, XD6, XD7, YD1, YD2, YD3, YD4, YD5, YD6, YD7, WD1, WD2, WD3, WD6, WD7

MODELS903.61 /66 /67, 904.61 /66 with CODE (ZU7) National version for Canada

MODELS903.61 /66 /67, 904.61 /66 with CODE (ZU8) National version for USA

MODELS903.61 /62 /66 /67, 904.61 /62 /66 with CODE (ZU9) National version for Mexico

PE82.10-D-2000-99E	Wiring diagram of exterior lights		PE82.10-D-2000-99E
PE82.10-D-2000-60E	Legend for wiring diagram of exterior lights		PE82.10-D-2000-60E
OV00.01-N-1901-03D	Use of wiring diagrams		OV00.01-N-1901-03D
OV00.01-N-1901E	Search aid for all wiring diagram groups		OV00.01-N-1901E
OV00.01-N-1001-27E	Abbreviations for wiring diagrams		OV00.01-N-1001-27E
GF00.19-D-2000D	Arrangement and assignment of ground points		GF00.19-D-2000D
GF00.19-D-3100-36C	Arrangement and assignment of terminal block connectors exterior lights		GF00.19-D-3100-36C
PE82.00-D-1100D	Overview of wiring diagrams for electrical system, body	Further wiring diagrams	PE82.00-D-1100D

MODELS XD1, XD2, XD3, XD4, XD5, XD6, XD7, YD1, YD2, YD3, YD4, YD5, YD6, YD7, WD1, WD2, WD3, WD6, WD7

MODEL 903.61 /66 /67, 904.61 /66

with CODE (F68) Left and right outside rearview mirrors, heated and electrically adjustable
with CODE (ZU7) National version for Canada

MODEL 903.61 /66 /67, 904.61 /66

with CODE (F68) Left and right outside rearview mirrors, heated and electrically adjustable
with CODE (ZU8) National version for USA

MODEL 903.61 /62 /66 /67, 904.61 /62 /66

with CODE (F68) Left and right outside rearview mirrors, heated and electrically adjustable
with CODE (ZU9) National version for Mexico

PE88.79-D-2000-99F	Wiring diagram of outside mirrors		PE88.79-D-2000-99F
PE88.79-D-2000-60F	Legend of wiring diagram of outside rearview mirrors		PE88.79-D-2000-60F
OV00.01-N-1901-03D	Use of wiring diagrams		OV00.01-N-1901-03D
OV00.01-N-1901E	Search aid for all wiring diagram groups		OV00.01-N-1901E
OV00.01-N-1001-27E	Abbreviations for wiring diagrams		OV00.01-N-1001-27E
GF00.19-D-2000D	Arrangement and assignment of ground points		GF00.19-D-2000D
GF00.19-D-3100-48C	Arrangement and assignment of terminal block connectors outside mirrors		GF00.19-D-3100-48C

MODEL YD1##, YD2##, YD3##, YD4##, YD5##, YD6##, YD7##, WD1##, WD2##, WD3##, WD6##, WD7##
up to 605787 up to 28.11.03

MODEL 903.66# /67#, 904.66# ## up to 605787 up to 28.11.03

with CODE (H22) Heated rear window

with CODE (ZU7) National version for Canada

MODEL 903.66# /67#, 904.66# ## up to 605787 up to 28.11.03

with CODE (H22) Heated rear window

with CODE (ZU8) National version for USA

MODEL 903.66# /67#, 904.66# ## up to 605787 up to 28.11.03

with CODE (H22) Heated rear window

with CODE (ZU9) National version for Mexico

PE67.29-D-2000-99E	Wiring diagram of heated rear window		PE67.29-D-2000-99E
PE67.29-D-2000-60E	Legend for wiring diagram of heated rear window		PE67.29-D-2000-60E
OV00.01-N-1901-03D	Use of wiring diagrams		OV00.01-N-1901-03D
OV00.01-N-1901E	Search aid for all wiring diagram groups		OV00.01-N-1901E
OV00.01-N-1001-27E	Abbreviations for wiring diagrams		OV00.01-N-1001-27E
GF00.19-D-2000D	Arrangement and assignment of ground points		GF00.19-D-2000D
GF00.19-D-3100-28C	Arrangement and assignment of terminal block connectors heated rear window		GF00.19-D-3100-28C

MODEL YD1##, YD2##, YD3##, YD4##, YD5##, YD6##, YD7##, WD1##, WD2##, WD3##, WD6##, WD7##
up to 605787 up to 28.11.03

MODEL 903.66# /67#, 904.66# ## up to 605787 up to 28.11.03

with CODE (FY1) Anti-theft alarm with interior motion sensor, towing sensor and battery-operated horn

with CODE (H22) Heated rear window

with CODE (ZU7) National version for Canada

MODEL 903.66# /67#, 904.66# ## up to 605787 up to 28.11.03

with CODE (FY1) Anti-theft alarm with interior motion sensor, towing sensor and battery-operated horn

with CODE (H22) Heated rear window

with CODE (ZU8) National version for USA

PE67.29-D-2000-99F	Wiring diagram of heated rear window		PE67.29-D-2000-99F
PE67.29-D-2000-60F	Legend for wiring diagram of heated rear window		PE67.29-D-2000-60F
OV00.01-N-1901-03D	Use of wiring diagrams		OV00.01-N-1901-03D
OV00.01-N-1901E	Search aid for all wiring diagram groups		OV00.01-N-1901E
OV00.01-N-1001-27E	Abbreviations for wiring diagrams		OV00.01-N-1001-27E
GF00.19-D-2000D	Arrangement and assignment of ground points		GF00.19-D-2000D
GF00.19-D-3100-28C	Arrangement and assignment of terminal block connectors heated rear window		GF00.19-D-3100-28C

MODEL YD1##, YD2##, YD3##, YD4##, YD5##, YD6##, YD7##, WD1##, WD2##, WD3##, WD6##, WD7##
 ### as of 605788 as of 1.12.03

MODEL 903.66# /67#, 904.66# ## as of 605788 as of 1.12.03

with CODE (H22) Heated rear window

with CODE (ZU7) National version for Canada

MODEL 903.66# /67#, 904.66# ## as of 605788 as of 1.12.03

with CODE (H22) Heated rear window

with CODE (ZU8) National version for USA

MODEL 903.66# /67#, 904.66# ## as of 605788 as of 1.12.03

with CODE (H22) Heated rear window

with CODE (ZU9) National version for Mexico

PE67.29-D-2000-99G	Wiring diagram of heated rear window		PE67.29-D-2000-99G
PE67.29-D-2000-60G	Legend for wiring diagram of heated rear window		PE67.29-D-2000-60G
OV00.01-N-1901-03D	Use of wiring diagrams		OV00.01-N-1901-03D
OV00.01-N-1901E	Search aid for all wiring diagram groups		OV00.01-N-1901E
OV00.01-N-1001-27E	Abbreviations for wiring diagrams		OV00.01-N-1001-27E
GF00.19-D-2000D	Arrangement and assignment of ground points		GF00.19-D-2000D
GF00.19-D-3100-28C	Arrangement and assignment of terminal blocks of heated rear window		GF00.19-D-3100-28C

MODEL YD1##, YD2##, YD3##, YD4##, YD5##, YD6##, YD7##, WD1##, WD2##, WD3##, WD6##, WD7##
 ### as of 605788 as of 1.12.03

MODEL 903.66# /67#, 904.66# ## as of 605788 as of 1.12.03

with CODE (FZ4) Anti-theft alarm with interior motion sensor and towing sensor

with CODE (H22) Heated rear window

with CODE (ZU7) National version for Canada

MODEL 903.66# /67#, 904.66# ## as of 605788 as of 1.12.03

with CODE (FZ4) Anti-theft alarm with interior motion sensor and towing sensor

with CODE (H22) Heated rear window

with CODE (ZU8) National version for USA

PE67.29-D-2000-99H	Wiring diagram of heated rear window		PE67.29-D-2000-99H
PE67.29-D-2000-60H	Legend for wiring diagram of heated rear window		PE67.29-D-2000-60H
OV00.01-N-1901-03D	Use of wiring diagrams		OV00.01-N-1901-03D
OV00.01-N-1901E	Search aid for all wiring diagram groups		OV00.01-N-1901E
OV00.01-N-1001-27E	Abbreviations for wiring diagrams		OV00.01-N-1001-27E
GF00.19-D-2000D	Arrangement and assignment of ground points		GF00.19-D-2000D
GF00.19-D-3100-28C	Arrangement and assignment of terminal blocks of heated rear window		GF00.19-D-3100-28C

MODEL YD1, YD2, YD3, YD4, YD5, YD6, YD7, WD1, WD2, WD3, WD6, WD7

MODELS 903.61 /66 /67, 904.61 /66

with CODE (LB5) Center high-mounted stop lamp

with CODE (ZU7) Canada national version

MODELS 903.61 /66 /67, 904.61 /66

with CODE (LB5) Center high-mounted stop lamp

with CODE (ZU8) USA national version

MODELS 903.61 /66 /67, 904.61 /66

with CODE (LB5) Center high-mounted stop lamp

with CODE (ZU9) Mexico national version

PE82.10-D-2300-99B	Wiring diagram of stop lamp		PE82.10-D-2300-99B
PE82.10-D-2300-60B	Legend for wiring diagram of stop lamp		PE82.10-D-2300-60B
OV00.01-N-1901-03D	Use of wiring diagrams		OV00.01-N-1901-03D
OV00.01-N-1901E	Search aid for all wiring diagram groups		OV00.01-N-1901E
OV00.01-N-1001-27E	Abbreviations for wiring diagrams		OV00.01-N-1001-27E
GF00.19-D-2000D	Arrangement and assignment of ground points		GF00.19-D-2000D
GF00.19-D-3100-58B	Arrangement and assignment of terminal block connectors stop lamp		GF00.19-D-3100-58B
PE54.00-D-1100D	Overview of wiring diagrams for electrical system, equipment and instruments	Further wiring diagrams	PE54.00-D-1100D

PE00.19-D-2200D	Wiring diagram CAN bus engine	19.2.01
------------------------	--------------------------------------	----------------

MODELSXD1##, XD2##, XD3##, XD4##, XD5##, XD6##, XD7##, YD1##, YD2##, YD3##, YD4##, YD5##, YD6##, YD7##, WD1##, WD2##, WD3##, WD6##, WD7## ### up to 529900 up to 4/30/03
MODELS903.61# /66# /67#, 904.61# /66# ## up to 529900 up to 4/30/03 with CODE (ZU7) National version for Canada
MODELS903.61# /66# /67#, 904.61# /66# ## up to 529900 up to 4/30/03 with CODE (ZU8) National version for USA
MODELS903.61# /62# /66# /67#, 904.61# /62# /66# ## up to 529900 up to 4/30/03 with CODE (ZU9) National version for Mexico

PE00.19-D-2200-99D	Wiring diagram CAN bus engine		PE00.19-D-2200-99D
PE00.19-D-2200-60D	Legend for wiring diagram of CAN bus - engine		PE00.19-D-2200-60D
OV00.01-N-1901-03D	Use of wiring diagrams		OV00.01-N-1901-03D
OV00.01-N-1901E	Search aid for all wiring diagram groups		OV00.01-N-1901E
OV00.01-N-1001-27E	Abbreviations for wiring diagrams		OV00.01-N-1001-27E
GF00.19-D-2000D	Arrangement and assignment of ground points		GF00.19-D-2000D
GF00.19-D-3100-57B	Arrangement and assignment of terminal block connectors engine CAN databus		GF00.19-D-3100-57B

PE00.19-D-2200E	Wiring diagram CAN bus engine	23.6.03
------------------------	--------------------------------------	----------------

MODELSXD1##, XD2##, XD3##, XD4##, XD5##, XD6##, XD7##, YD1##, YD2##, YD3##, YD4##, YD5##, YD6##, YD7##, WD1##, WD2##, WD3##, WD6##, WD7## ### as of 529901 as of 5/5/03
MODELS903.61# /66# /67#, 904.61# /66# ## as of 529901 as of 5/5/03 with CODE (ZU7) National version for Canada
MODELS903.61# /66# /67#, 904.61# /66# ## as of 529901 as of 5/5/03 with CODE (ZU8) National version for USA
MODELS903.61# /62# /66# /67#, 904.61# /62# /66# ## as of 529901 as of 5/5/03 with CODE (ZU9) National version for Mexico

PE00.19-D-2200-99E	Wiring diagram CAN bus engine		PE00.19-D-2200-99E
PE00.19-D-2200-60E	Legend for wiring diagram of CAN bus - engine		PE00.19-D-2200-60E
OV00.01-N-1901-03D	Use of wiring diagrams		OV00.01-N-1901-03D
OV00.01-N-1901E	Search aid for all wiring diagram groups		OV00.01-N-1901E
OV00.01-N-1001-27E	Abbreviations for wiring diagrams		OV00.01-N-1001-27E
GF00.19-D-2000D	Arrangement and assignment of ground points		GF00.19-D-2000D
GF00.19-D-3100-57B	Arrangement and assignment of terminal block connectors engine CAN databus		GF00.19-D-3100-57B

PE07.16-D-2000E	Wiring diagram of common rail diesel injection (CDI) control unit	19.2.01
------------------------	--	----------------

ENGINE612.981 in MODEL XD1, XD2, XD3, XD4, XD5, XD6, XD7, YD1, YD2, YD3, YD4, YD5, YD6, YD7, WD1, WD2, WD3, WD6, WD7

ENGINE612.981 in MODEL 903.61 /66 /67, 904.61 /66 with CODE (ZU7) National version for Canada

ENGINE612.981 in MODEL 903.61 /66 /67, 904.61 /66 with CODE (ZU8) National version for USA

ENGINE612.981 in MODEL 903.61 /62 /66 /67, 904.61 /62 /66 with CODE (ZU9) National version for Mexico vehicle wiring harness

PE07.16-D-2000-99E	Wiring diagram of common rail diesel injection (CDI) control unit		PE07.16-D-2000-99E
PE07.16-D-2000-60E	Legend of wiring diagram of common rail diesel injection (CDI)		PE07.16-D-2000-60E
OV00.01-N-1901-03D	Use of wiring diagrams		OV00.01-N-1901-03D
OV00.01-N-1901E	Search aid for all wiring diagram groups		OV00.01-N-1901E
OV00.01-N-1001-27E	Abbreviations for wiring diagrams		OV00.01-N-1001-27E
GF00.19-D-2000D	Arrangement and assignment of ground points		GF00.19-D-2000D
GF00.19-D-3100-55B	Arrangement and assignment of terminal block connectors common rail diesel injection (CDI)		GF00.19-D-3100-55B
PE00.19-D-1100D	Survey of wiring diagrams covering all function groups	Further wiring diagrams	PE00.19-D-1100D
PE15.00-D-1100D	Survey of wiring diagrams, electrical system, engine	Further wiring diagrams	PE15.00-D-1100D

PE07.16-D-2000F	Wiring diagram of common rail diesel injection (CDI) control unit	19.2.01
------------------------	--	----------------

ENGINE612.981 in MODEL XD1, XD2, XD3, XD4, XD5, XD6, XD7, YD1, YD2, YD3, YD4, YD5, YD6, YD7, WD1, WD2, WD3, WD6, WD7

ENGINE612.981 in MODEL 903.61 /66 /67, 904.61 /66 with CODE (ZU7) National version for Canada

ENGINE612.981 in MODEL 903.66 /67, 904.61 /66 with CODE (ZU8) National version for USA

ENGINE612.981 in MODEL 903.61 /62 /66 /67, 904.61 /62 /66 with CODE (ZU9) National version for Mexico engine wiring harness

PE07.16-D-2000-99F	Wiring diagram of common rail diesel injection (CDI) control unit		PE07.16-D-2000-99F
PE07.16-D-2000-60F	Legend of wiring diagram of common rail diesel injection (CDI)		PE07.16-D-2000-60F
OV00.01-N-1901-03D	Use of wiring diagrams		OV00.01-N-1901-03D
OV00.01-N-1901E	Search aid for all wiring diagram groups		OV00.01-N-1901E
OV00.01-N-1001-27E	Abbreviations for wiring diagrams		OV00.01-N-1001-27E
GF00.19-D-2000D	Arrangement and assignment of ground points		GF00.19-D-2000D
GF00.19-D-3100-55B	Arrangement and assignment of terminal block connectors common rail diesel injection (CDI)		GF00.19-D-3100-55B

PE07.16-D-2000G	Wiring diagram of common rail diesel injection (CDI) control unit	23.6.03
------------------------	--	----------------

ENGINE647.981 in MODEL XD1, XD2, XD3, XD4, XD5, XD6, XD7, YD1, YD2, YD3, YD4, YD5, YD6, YD7, WD1, WD2, WD3, WD6, WD7

ENGINE647.981 in MODEL 903.61 /66 /67, 904.61 /66 with CODE (ZU7) National version for Canada

ENGINE647.981 in MODEL 903.61 /66 /67, 904.61 /66 with CODE (ZU8) National version for USA

ENGINE647.981 in MODEL 903.61 /62 /66 /67, 904.61 /62 /66 with CODE (ZU9) National version for Mexico engine wiring harness

PE07.16-D-2000-99G	Wiring diagram of common rail diesel injection (CDI) control unit		PE07.16-D-2000-99G
PE07.16-D-2000-60G	Legend of wiring diagram of common rail diesel injection (CDI)		PE07.16-D-2000-60G
OV00.01-N-1901-03D	Use of wiring diagrams		OV00.01-N-1901-03D
OV00.01-N-1901E	Search aid for all wiring diagram groups		OV00.01-N-1901E
OV00.01-N-1001-27E	Abbreviations for wiring diagrams		OV00.01-N-1001-27E
GF00.19-D-2000D	Arrangement and assignment of ground points		GF00.19-D-2000D
PE00.19-D-1100D	Survey of wiring diagrams covering all function groups	Further wiring diagrams	PE00.19-D-1100D
PE15.00-D-1100D	Survey of wiring diagrams, electrical system, engine	Further wiring diagrams	PE15.00-D-1100D

PE07.16-D-2000H	Wiring diagram of common rail diesel injection (CDI) control unit	23.6.03
------------------------	--	----------------

ENGINE647.981 in MODEL XD1, XD2, XD3, XD4, XD5, XD6, XD7, YD1, YD2, YD3, YD4, YD5, YD6, YD7, WD1, WD2, WD3, WD6, WD7

ENGINE647.981 in MODEL 903.61 /66 /67, 904.61 /66 with CODE (ZU7) National version for Canada

ENGINE647.981 in MODEL 903.61 /66 /67, 904.61 /66 with CODE (ZU8) National version for USA

ENGINE647.981 in MODEL 903.61 /62 /66 /67, 904.61 /62 /66 with CODE (ZU9) National version for Mexico vehicle wiring harness

PE07.16-D-2000-99H	Wiring diagram of common rail diesel injection (CDI) control unit		PE07.16-D-2000-99H
PE07.16-D-2000-60H	Legend of wiring diagram of common rail diesel injection (CDI)		PE07.16-D-2000-60H
OV00.01-N-1901-03D	Use of wiring diagrams		OV00.01-N-1901-03D
OV00.01-N-1901E	Search aid for all wiring diagram groups		OV00.01-N-1901E
OV00.01-N-1001-27E	Abbreviations for wiring diagrams		OV00.01-N-1001-27E
GF00.19-D-2000D	Arrangement and assignment of ground points		GF00.19-D-2000D

MODEL YD1, YD2, YD3, YD4, YD5, YD6, YD7, WD1, WD2, WD3, WD6, WD7

MODELS 903.61 /66 /67, 904.61 /66

with CODE (H72) Electric roof fan

with CODE (ZU7) Canada national version

MODELS 903.61 /66 /67, 904.61 /66

with CODE (H72) Electric roof fan

with CODE (ZU8) USA national version

MODELS 903.61 /66 /67, 904.61 /66

with CODE (H72) Electric roof fan

with CODE (ZU9) Mexico national version

PE83.10-D-2100-99B	Wiring diagram roof fan		PE83.10-D-2100-99B
PE83.10-D-2100-60B	Legend of wiring diagram roof fan		PE83.10-D-2100-60B
OV00.01-N-1901-03D	Use of wiring diagrams		OV00.01-N-1901-03D
OV00.01-N-1901E	Search aid for all wiring diagram groups		OV00.01-N-1901E
OV00.01-N-1001-27E	Abbreviations for wiring diagrams		OV00.01-N-1001-27E
GF00.19-D-2000D	Arrangement and assignment of ground points		GF00.19-D-2000D
GF00.19-D-3100-67A	Arrangement and assignment of terminal block connectors roof fan		GF00.19-D-3100-67A

PE35.40-D-2000D	Wiring diagram rear axle differential lock operating mechanism	19.2.01
------------------------	---	----------------

REAR 741 in MODEL XD1, XD2, XD3, XD4, XD5, XD6, XD7, YD1, YD2, YD3, YD4, YD5, YD6, YD7,
 AXLE WD1, WD2, WD3, WD6, WD7
 REAR 741 in MODEL 903.61 /66 /67, 904.61 /66
 AXLE

with CODE (A71) Rear axle with differential lock
 with CODE (ZU7) National version for Canada

REAR 741 in MODEL 903.61 /66 /67, 904.61 /66
 AXLE

with CODE (A71) Rear axle with differential lock
 with CODE (ZU8) National version for USA

PE35.40-D-2000-99D	Wiring diagram rear axle differential lock operating mechanism		PE35.40-D-2000-99D
PE35.40-D-2000-60D	Legend of wiring diagram for rear axle differential lock operating mechanism		PE35.40-D-2000-60D
OV00.01-N-1901-03D	Use of wiring diagrams		OV00.01-N-1901-03D
OV00.01-N-1901E	Search aid for all wiring diagram groups		OV00.01-N-1901E
OV00.01-N-1001-27E	Abbreviations for wiring diagrams		OV00.01-N-1001-27E
GF00.19-D-2000D	Arrangement and assignment of ground points		GF00.19-D-2000D
GF00.19-D-3100-20C	Arrangement and assignment of terminal block connectors rear axle differential lock		GF00.19-D-3100-20C

MODELSXD1, XD2, XD3, XD4, XD5, XD6, XD7, YD1, YD2, YD3, YD4, YD5, YD6, YD7, WD1, WD2, WD3, WD6, WD7

MODELS903.61 /66 /67, 904.61 /66

with CODE (LB9) Illuminated exit

with CODE (ZU7) Canada national version

MODELS903.61 /66 /67, 904.61 /66

with CODE (LB9) Illuminated exit

with CODE (ZU8) USA national version

PE82.20-D-2100-99C	Wiring diagram of entrance/exit lamps		PE82.20-D-2100-99C
PE82.20-D-2100-60C	Legend for wiring diagram of entrance/exit lamps		PE82.20-D-2100-60C
OV00.01-N-1901-03D	Use of wiring diagrams		OV00.01-N-1901-03D
OV00.01-N-1901E	Search aid for all wiring diagram groups		OV00.01-N-1901E
OV00.01-N-1001-27E	Abbreviations for wiring diagrams		OV00.01-N-1001-27E
GF00.19-D-2000D	Arrangement and assignment of ground points		GF00.19-D-2000D
GF00.19-D-3100-53C	Arrangement and assignment of terminal block connectors entry/exit lamps		GF00.19-D-3100-53C

PE80.50-D-2000D	Wiring diagram of anti-theft alarm system (ATA)	20.3.01
------------------------	--	----------------

MODELS XD1, XD2, XD3, XD4, XD5, XD6, XD7, YD1, YD2, YD3, YD4, YD5, YD6, YD7, WD1, WD2, WD3, WD6, WD7

MODEL 903.61 /66 /67, 904.61 /66

with CODE (FY1) Anti-theft alarm with interior motion sensor, towing sensor and battery-operated horn

with CODE (ZU7) National version for Canada

MODEL 903.61 /66 /67, 904.61 /66

with CODE (FY1) Anti-theft alarm with interior motion sensor, towing sensor and battery-operated horn

with CODE (ZU8) National version for USA

PE80.50-D-2000-99D	Wiring diagram of anti-theft alarm system (ATA)		PE80.50-D-2000-99D
PE80.50-D-2000-60D	Legend for wiring diagram of anti-theft alarm system (ATA)		PE80.50-D-2000-60D
OV00.01-N-1901-03D	Use of wiring diagrams		OV00.01-N-1901-03D
OV00.01-N-1901E	Search aid for all wiring diagram groups		OV00.01-N-1901E
OV00.01-N-1001-27E	Abbreviations for wiring diagrams		OV00.01-N-1001-27E
GF00.19-D-2000D	Arrangement and assignment of ground points		GF00.19-D-2000D
GF00.19-D-3100-33C	Arrangement and assignment of terminal block connectors anti-theft alarm (ATA)		GF00.19-D-3100-33C
PE54.00-D-1100D	Overview of wiring diagrams for electrical system, equipment and instruments	Further wiring diagrams	PE54.00-D-1100D
PE82.00-D-1100D	Overview of wiring diagrams for electrical system, body	Further wiring diagrams	PE82.00-D-1100D

PE27.19-D-2100A	Wiring diagram of electronic transmission control (ETC)	19.2.01
------------------------	--	----------------

TRANSMISSION722.681 in MODELS XD1, XD2, XD3, XD4, XD5, XD6, XD7, YD1, YD2, YD3, YD4, YD5, YD6, YD7, WD1, WD2, WD3, WD6, WD7

TRANSMISSION722.681 in MODEL 903.61 /66 /67, 904.61 /66

with CODE (G40) Automatic transmission

with CODE (ZU7) National version for Canada

TRANSMISSION722.681 in MODEL 903.61 /66 /67, 904.61 /66

with CODE (G40) Automatic transmission

with CODE (ZU8) National version for USA

TRANSMISSION722.681 in MODEL 903.61 /62 /66 /67, 904.61 /62 /66

with CODE (G40) Automatic transmission

with CODE (ZU9) National version for Mexico

PE27.19-D-2100-99A	Wiring diagram of electronic transmission control (ETC)		PE27.19-D-2100-99A
PE27.19-D-2100-60A	Legend of wiring diagram of electronic transmission control (ETC)		PE27.19-D-2100-60A
OV00.01-N-1901-03D	Use of wiring diagrams		OV00.01-N-1901-03D
OV00.01-N-1901E	Search aid for all wiring diagram groups		OV00.01-N-1901E
OV00.01-N-1001-27E	Abbreviations for wiring diagrams		OV00.01-N-1001-27E
GF00.19-D-2000D	Arrangement and assignment of ground points		GF00.19-D-2000D
GF00.19-D-3100-66A	Arrangement and assignment of terminal blocks of electronic transmission control (ETC)		GF00.19-D-3100-66A
PE00.19-D-1100D	Survey of wiring diagrams covering all function groups	Further wiring diagrams	PE00.19-D-1100D
PE54.00-D-1100D	Overview of wiring diagrams for electrical system, equipment and instruments	Further wiring diagrams	PE54.00-D-1100D

PE42.45-D-2200B	Wiring diagram electronic stability program (ESP)	14.10.03
------------------------	--	-----------------

MODELS XD1, XD2, XD3, XD6, XD7, YD1, YD2, YD3, YD6, YD7, WD1, WD2, WD3, WD6, WD7

MODEL 903.61 /66 /67
with CODE (BB3) Electronic stability program
with CODE (ZU7) National version for Canada

MODEL 903.61 /66 /67
with CODE (BB3) Electronic stability program
with CODE (ZU8) National version for USA

PE42.45-D-2200-99B	Wiring diagram electronic stability program (ESP)		PE42.45-D-2200-99B
PE42.45-D-2200-60B	Legend of wiring diagram for electronic stability program (ESP)		PE42.45-D-2200-60B
OV00.01-N-1901-03D	Use of wiring diagrams		OV00.01-N-1901-03D
OV00.01-N-1901E	Search aid for all wiring diagram groups		OV00.01-N-1901E
OV00.01-N-1001-27E	Abbreviations for wiring diagrams		OV00.01-N-1001-27E
GF00.19-D-2000D	Arrangement and assignment of ground points		GF00.19-D-2000D
GF00.19-D-3100-61B	Arrangement and assignment of terminal block connectors anti-lock brake system (ABS)/acceleration slip regulation (ASR)		GF00.19-D-3100-61B
PE00.19-D-1100D	Survey of wiring diagrams covering all function groups	Further wiring diagrams	PE00.19-D-1100D
PE54.00-D-1100D	Overview of wiring diagrams for electrical system, equipment and instruments	Further wiring diagrams	PE54.00-D-1100D

MODEL XD1, XD2, XD3, XD4, XD5, XD6, XD7, YD1, YD2, YD3, YD4, YD5, YD6, YD7, WD1, WD2, WD3, WD6, WD7

MODEL 903.61 /66 /67, 904.61 /66

with CODE (V50) Two power windows

with CODE (ZU7) National version for Canada

MODEL 903.61 /66 /67, 904.61 /66

with CODE (V50) 2 power windows

with CODE (ZU8) National version for USA

MODEL 903.61 /62 /66 /67, 904.61 /62 /66

with CODE (V50) 2 power windows

with CODE (ZU9) National version for Mexico

PE72.29-D-2001-99D	Wiring diagram of power windows		PE72.29-D-2001-99D
PE72.29-D-2001-60D	Legend of wiring diagram of power windows		PE72.29-D-2001-60D
OV00.01-N-1901-03D	Use of wiring diagrams		OV00.01-N-1901-03D
OV00.01-N-1901E	Search aid for all wiring diagram groups		OV00.01-N-1901E
OV00.01-N-1001-27E	Abbreviations for wiring diagrams		OV00.01-N-1001-27E
GF00.19-D-2000D	Arrangement and assignment of ground points		GF00.19-D-2000D
GF00.19-D-3100-29C	Arrangement and assignment of terminal block connectors power windows		GF00.19-D-3100-29C

PE80.35-D-2200C	Wiring diagram of remote central locking with immobilizer and transponder	19.2.01
------------------------	--	----------------

MODELSXD1, XD2, XD3, XD4, XD5, XD6, XD7, YD1, YD2, YD3, YD4, YD5, YD6, YD7, WD1, WD2, WD3, WD6, WD7

MODELS903.61 /66 /67, 904.61 /66 with CODE (ZU7) National version for Canada

MODELS903.61 /66 /67, 904.61 /66 with CODE (ZU8) National version for USA

MODELS903.61 /62 /66 /67, 904.61 /62 /66 with CODE (ZU9) National version for Mexico

PE80.35-D-2200-99C	Wiring diagram of remote central locking with immobilizer and transponder		PE80.35-D-2200-99C
PE80.35-D-2200-60C	Legend of wiring diagram of remote central locking with immobilizer and transponder		PE80.35-D-2200-60C
OV00.01-N-1901-03D	Use of wiring diagrams		OV00.01-N-1901-03D
OV00.01-N-1901E	Search aid for all wiring diagram groups		OV00.01-N-1901E
OV00.01-N-1001-27E	Abbreviations for wiring diagrams		OV00.01-N-1001-27E
GF00.19-D-2000D	Arrangement and assignment of ground points		GF00.19-D-2000D
GF00.19-D-3100-32C	Arrangement and assignment of terminal block connectors radio remote control with immobilizer and transponder		GF00.19-D-3100-32C
PE00.19-D-1100D	Survey of wiring diagrams covering all function groups	Further wiring diagrams	PE00.19-D-1100D
PE54.00-D-1100D	Overview of wiring diagrams for electrical system, equipment and instruments	Further wiring diagrams	PE54.00-D-1100D
PE82.00-D-1100D	Overview of wiring diagrams for electrical system, body	Further wiring diagrams	PE82.00-D-1100D

MODELS XD1, XD2, XD3, XD4, XD5, XD6, XD7, YD1, YD2, YD3, YD4, YD5, YD6, YD7, WD1, WD2, WD3, WD6, WD7

MODEL 903.61 /66 /67, 904.61 /66

with CODE (J65) Outside temperature display
with CODE (ZU7) National version for Canada

MODEL 903.61 /66 /67, 904.61 /66

with CODE (J65) Outside temperature display
with CODE (ZU8) National version for USA

MODEL 903.61 /62 /66 /67, 904.61 /62 /66

with CODE (J65) Outside temperature display
with CODE (ZU9) National version for Mexico

PE54.30-D-2001-99G	Wiring diagram large instrument (instrument cluster)		PE54.30-D-2001-99G
PE54.30-D-2001-60G	Legend of wiring diagram large instrument (instrument cluster)		PE54.30-D-2001-60G
OV00.01-N-1901-03D	Use of wiring diagrams		OV00.01-N-1901-03D
OV00.01-N-1901E	Search aid for all wiring diagram groups		OV00.01-N-1901E
OV00.01-N-1001-27E	Abbreviations for wiring diagrams		OV00.01-N-1001-27E
GF00.19-D-2000D	Arrangement and assignment of ground points		GF00.19-D-2000D
GF00.19-D-3100-24C	Arrangement and assignment of terminal block connectors instrument cluster		GF00.19-D-3100-24C
PE00.19-D-1100D	Survey of wiring diagrams covering all function groups	Further wiring diagrams	PE00.19-D-1100D
PE54.00-D-1100D	Overview of wiring diagrams for electrical system, equipment and instruments	Further wiring diagrams	PE54.00-D-1100D
PE82.00-D-1100D	Overview of wiring diagrams for electrical system, body	Further wiring diagrams	PE82.00-D-1100D

PE83.20-D-2000E	Wiring diagram heater	19.2.01
------------------------	------------------------------	----------------

MODELS YD1##, YD2##, YD3##, YD4##, YD5##, WD1##, WD2##, WD3## ### up to 365850 up to 18.1.02
MODELS 903.66# /67#, 904.66# ## up to 365850 up to 18.1.02 with CODE (ZU8) USA national version

PE83.20-D-2000-99E	Wiring diagram heater		PE83.20-D-2000-99E
PE83.20-D-2000-60E	Legend of wiring diagram heater		PE83.20-D-2000-60E
OV00.01-N-1901-03D	Use of wiring diagrams		OV00.01-N-1901-03D
OV00.01-N-1901E	Search aid for all wiring diagram groups		OV00.01-N-1901E
OV00.01-N-1001-27E	Abbreviations for wiring diagrams		OV00.01-N-1001-27E
GF00.19-D-2000D	Arrangement and assignment of ground points		GF00.19-D-2000D
GF00.19-D-3100-45C	Arrangement and assignment of terminal block connectors heating		GF00.19-D-3100-45C
PE54.00-D-1100D	Overview of wiring diagrams for electrical system, equipment and instruments	Further wiring diagrams	PE54.00-D-1100D
PE83.00-D-1100D	Overview of wiring diagrams for climate control	Further wiring diagrams	PE83.00-D-1100D

PE83.20-D-2000F	Wiring diagram heater	19.2.01
------------------------	------------------------------	----------------

MODELS YD1##, YD2##, YD3##, YD4##, YD5##, WD1##, WD2##, WD3## ### up to 365850 up to 18.1.02
MODELS 903.66# /67#, 904.66# ## up to 365850 up to 18.1.02
with CODE (H25) "Heatmatic" automatic heater control
with CODE (ZU8) USA national version

PE83.20-D-2000-99F	Wiring diagram heater		PE83.20-D-2000-99F
PE83.20-D-2000-60F	Legend of wiring diagram heater		PE83.20-D-2000-60F
OV00.01-N-1901-03D	Use of wiring diagrams		OV00.01-N-1901-03D
OV00.01-N-1901E	Search aid for all wiring diagram groups		OV00.01-N-1901E
OV00.01-N-1001-27E	Abbreviations for wiring diagrams		OV00.01-N-1001-27E
GF00.19-D-2000D	Arrangement and assignment of ground points		GF00.19-D-2000D
GF00.19-D-3100-45C	Arrangement and assignment of terminal block connectors heating		GF00.19-D-3100-45C
PE00.19-D-1100D	Survey of wiring diagrams covering all function groups	Further wiring diagrams	PE00.19-D-1100D
PE54.00-D-1100D	Overview of wiring diagrams for electrical system, equipment and instruments	Further wiring diagrams	PE54.00-D-1100D
PE83.00-D-1100D	Overview of wiring diagrams for climate control	Further wiring diagrams	PE83.00-D-1100D

PE83.20-D-2000G	Wiring diagram heater	21.3.02
------------------------	------------------------------	----------------

MODELSXD1, XD2, XD3, XD4, XD5, XD6, XD7,

YD1##, YD2##, YD3##, YD4##, YD5##, YD6##, YD7##, WD1##, WD2##, WD3##, WD6##, WD7##
 ### from 365851 as of 21.1.02

MODELS903.61 /66 /67, 904.61 /66 with CODE (ZU7) Canada national version

MODELS903.61# /66# /67#, 904.61# /66# ## from 365851 as of 21.1.02 with CODE (ZU8) USA national version

MODELS903.61 /62 /66 /67, 904.61 /62 /66 with CODE (ZU9) Mexico national version

PE83.20-D-2000-99G	Wiring diagram heater		PE83.20-D-2000-99G
PE83.20-D-2000-60G	Legend of wiring diagram heater		PE83.20-D-2000-60G
OV00.01-N-1901-03D	Use of wiring diagrams		OV00.01-N-1901-03D
OV00.01-N-1901E	Search aid for all wiring diagram groups		OV00.01-N-1901E
OV00.01-N-1001-27E	Abbreviations for wiring diagrams		OV00.01-N-1001-27E
GF00.19-D-2000D	Arrangement and assignment of ground points		GF00.19-D-2000D
GF00.19-D-3100-45C	Arrangement and assignment of terminal block connectors heating		GF00.19-D-3100-45C
PE54.00-D-1100D	Overview of wiring diagrams for electrical system, equipment and instruments	Further wiring diagrams	PE54.00-D-1100D
PE83.00-D-1100D	Overview of wiring diagrams for climate control	Further wiring diagrams	PE83.00-D-1100D

PE83.20-D-2000H	Wiring diagram heater	21.3.02
------------------------	------------------------------	----------------

MODELSXD1, XD2, XD3, XD4, XD5, XD6, XD7,

YD1##, YD2##, YD3##, YD4##, YD5##, YD6##, YD7##, WD1##, WD2##, WD3##, WD6##, WD7##
 ### from 365851 as of 21.1.02

MODELS903.61 /66 /67, 904.61 /66 with CODE (ZU7) Canada national version

MODELS903.61# /66# /67#, 904.61# /66# ## from 365851 as of 21.1.02 with CODE (ZU8) USA national version

MODELS903.61 /62 /66 /67, 904.61 /62 /66 with CODE (ZU9) Mexico national version

PE83.20-D-2000-99H	Wiring diagram heater		PE83.20-D-2000-99H
PE83.20-D-2000-60H	Legend of wiring diagram heater		PE83.20-D-2000-60H
OV00.01-N-1901-03D	Use of wiring diagrams		OV00.01-N-1901-03D
OV00.01-N-1901E	Search aid for all wiring diagram groups		OV00.01-N-1901E
OV00.01-N-1001-27E	Abbreviations for wiring diagrams		OV00.01-N-1001-27E
GF00.19-D-2000D	Arrangement and assignment of ground points		GF00.19-D-2000D
GF00.19-D-3100-45C	Arrangement and assignment of terminal block connectors heating		GF00.19-D-3100-45C
PE54.00-D-1100D	Overview of wiring diagrams for electrical system, equipment and instruments	Further wiring diagrams	PE54.00-D-1100D
PE83.00-D-1100D	Overview of wiring diagrams for climate control	Further wiring diagrams	PE83.00-D-1100D

PE82.20-D-2000L	Wiring diagram interior lights	19.2.01
------------------------	---------------------------------------	----------------

MODELSXD1, XD2, XD3, XD4, XD5, XD6, XD7, YD1, YD2, YD3, YD4, YD5, YD6, YD7, WD1, WD2, WD3, WD6, WD7

MODELS903.61 /66 /67, 904.61 /66 with CODE (ZU7) National version for Canada

MODELS903.61 /66 /67, 904.61 /66 with CODE (ZU8) National version for USA

MODELS903.61 /62 /66 /67, 904.61 /62 /66 with CODE (ZU9) National version for Mexico

PE82.20-D-2000-99L	Wiring diagram interior lights		PE82.20-D-2000-99L
PE82.20-D-2000-60L	Legend for wiring diagram of interior lights		PE82.20-D-2000-60L
OV00.01-N-1901-03D	Use of wiring diagrams		OV00.01-N-1901-03D
OV00.01-N-1901E	Search aid for all wiring diagram groups		OV00.01-N-1901E
OV00.01-N-1001-27E	Abbreviations for wiring diagrams		OV00.01-N-1001-27E
GF00.19-D-2000D	Arrangement and assignment of ground points		GF00.19-D-2000D
GF00.19-D-3100-40D	Arrangement and assignment of terminal block connectors interior lights		GF00.19-D-3100-40D

PE82.20-D-2000M	Wiring diagram interior lights	19.2.01
------------------------	---------------------------------------	----------------

MODEL YD1##, YD2##, YD3##, YD4##, YD5##, YD6##, YD7##, WD1##, WD2##, WD3##, WD6##, WD7##
 ### up to 605787 up to 28.11.03

MODEL 903.61# /66# /67#, 904.61# /66# ## up to 605787 up to 28.11.03

with CODE (L63) Cargo area roof light

with CODE (ZU7) National version for Canada

MODEL 903.61# /66# /67#, 904.61# /66# ## up to 605787 up to 28.11.03

with CODE (L63) Cargo area roof light

with CODE (ZU8) National version for USA

MODEL 903.61# /66# /67#, 904.61# /66# ## up to 605787 up to 28.11.03

with CODE (L63) Cargo area roof light

with CODE (ZU9) National version for Mexico

PE82.20-D-2000-99M	Wiring diagram interior lights		PE82.20-D-2000-99M
PE82.20-D-2000-60M	Legend for wiring diagram of interior lights		PE82.20-D-2000-60M
OV00.01-N-1901-03D	Use of wiring diagrams		OV00.01-N-1901-03D
OV00.01-N-1901E	Search aid for all wiring diagram groups		OV00.01-N-1901E
OV00.01-N-1001-27E	Abbreviations for wiring diagrams		OV00.01-N-1001-27E
GF00.19-D-2000D	Arrangement and assignment of ground points		GF00.19-D-2000D
GF00.19-D-3100-40G	Arrangement and assignment of terminal block connectors interior lights		GF00.19-D-3100-40G

PE82.20-D-2000N	Wiring diagram interior lights	21.4.04
------------------------	---------------------------------------	----------------

MODEL YD1##, YD2##, YD3##, YD4##, YD5##, YD6##, YD7##, WD1##, WD2##, WD3##, WD6##, WD7##
 ### as of 605788 as of 1.12.03

MODEL 903.61# /66# /67#, 904.61# /66# ## as of 605788 as of 1.12.03

with CODE (L63) Cargo area roof light

with CODE (ZU7) National version for Canada

MODEL 903.61# /66# /67#, 904.61# /66# ## as of 605788 as of 1.12.03

with CODE (L63) Cargo area roof light

with CODE (ZU8) National version for USA

MODEL 903.61# /66# /67#, 904.61# /66# ## as of 605788 as of 1.12.03

with CODE (L63) Cargo area roof light

with CODE (ZU9) National version for Mexico

PE82.20-D-2000-99N	Wiring diagram interior lights		PE82.20-D-2000-99N
PE82.20-D-2000-60N	Legend of wiring diagram for interior lights		PE82.20-D-2000-60N
OV00.01-N-1901-03D	Use of wiring diagrams		OV00.01-N-1901-03D
OV00.01-N-1901E	Search aid for all wiring diagram groups		OV00.01-N-1901E
OV00.01-N-1001-27E	Abbreviations for wiring diagrams		OV00.01-N-1001-27E
GF00.19-D-2000D	Arrangement and assignment of ground points		GF00.19-D-2000D
GF00.19-D-3100-40G	Arrangement and assignment of terminal block connectors interior lights		GF00.19-D-3100-40G

MODELS YD1##, YD2##, YD3##, YD4##, YD5##, WD1##, WD2##, WD3## ### up to 365850 up to 18.1.02
 MODELS 903.66# /67#, 904.66# ## up to 365850 up to 18.1.02
 with CODE (HH9) Automatic air conditioning "Tempmatic"
 with CODE (ZU8) National version for USA

PE83.30-D-2001-99B	Wiring diagram of climate control		PE83.30-D-2001-99B
PE83.30-D-2001-60B	Legend of wiring diagram of climate control		PE83.30-D-2001-60B
OV00.01-N-1901-03D	Use of wiring diagrams		OV00.01-N-1901-03D
OV00.01-N-1901E	Search aid for all wiring diagram groups		OV00.01-N-1901E
OV00.01-N-1001-27E	Abbreviations for wiring diagrams		OV00.01-N-1001-27E
GF00.19-D-2000D	Arrangement and assignment of ground points		GF00.19-D-2000D
GF00.19-D-3100-69A	Arrangement and assignment of climate control terminal blocks		GF00.19-D-3100-69A
PE00.19-D-1100D	Survey of wiring diagrams covering all function groups	Further wiring diagrams	PE00.19-D-1100D
PE54.00-D-1100D	Overview of wiring diagrams for electrical system, equipment and instruments	Further wiring diagrams	PE54.00-D-1100D
PE83.00-D-1100D	Overview of wiring diagrams for climate control	Further wiring diagrams	PE83.00-D-1100D

PE83.30-D-2001C	Wiring diagram of climate control	19.2.01
------------------------	--	----------------

MODEL WD1, WD2, WD3, WD6, WD7

MODEL 903.67

with CODE (HH7) Additional air conditioning in rear

with CODE (ZU8) USA national version

PE83.30-D-2001-99C	Wiring diagram of climate control		PE83.30-D-2001-99C
PE83.30-D-2001-60C	Legend of wiring diagram of climate control		PE83.30-D-2001-60C
OV00.01-N-1901-03D	Use of wiring diagrams		OV00.01-N-1901-03D
OV00.01-N-1901E	Search aid for all wiring diagram groups		OV00.01-N-1901E
OV00.01-N-1001-27E	Abbreviations for wiring diagrams		OV00.01-N-1001-27E
GF00.19-D-2000D	Arrangement and assignment of ground points		GF00.19-D-2000D
GF00.19-D-3100-69B	Arrangement and assignment of climate control terminal blocks		GF00.19-D-3100-69B

PE83.30-D-2001E	Wiring diagram of climate control	21.3.02
------------------------	--	----------------

MODELSXD1, XD2, XD3, XD4, XD5, XD6, XD7,

YD1##, YD2##, YD3##, YD4##, YD5##, YD6##, YD7##, WD1##, WD2##, WD3##, WD6##, WD7##
from 365851 as of 21.1.02

MODELS903.61 /66 /67, 904.61 /66

with CODE (HH9) "Tempmatic" automatic air conditioning
with CODE (ZU7) Canada national version

MODELS903.61# /66# /67#, 904.61# /66# ## from 365851 as of 21.1.02

with CODE (HH9) "Tempmatic" automatic air conditioning
with CODE (ZU8) USA national version

MODELS903.61 /62 /66 /67, 904.61 /62 /66

with CODE (HH9) "Tempmatic" automatic air conditioning
with CODE (ZU9) Mexico national version

PE83.30-D-2001-99E	Wiring diagram of climate control		PE83.30-D-2001-99E
PE83.30-D-2001-60E	Legend of wiring diagram of climate control		PE83.30-D-2001-60E
OV00.01-N-1901-03D	Use of wiring diagrams		OV00.01-N-1901-03D
OV00.01-N-1901E	Search aid for all wiring diagram groups		OV00.01-N-1901E
OV00.01-N-1001-27E	Abbreviations for wiring diagrams		OV00.01-N-1001-27E
GF00.19-D-2000D	Arrangement and assignment of ground points		GF00.19-D-2000D
GF00.19-D-3100-69A	Arrangement and assignment of climate control terminal blocks		GF00.19-D-3100-69A
PE00.19-D-1100D	Survey of wiring diagrams covering all function groups	Further wiring diagrams	PE00.19-D-1100D
PE54.00-D-1100D	Overview of wiring diagrams for electrical system, equipment and instruments	Further wiring diagrams	PE54.00-D-1100D
PE83.00-D-1100D	Overview of wiring diagrams for climate control	Further wiring diagrams	PE83.00-D-1100D

MODEL YD1, YD2, YD3, YD4, YD5, YD6, YD7, WD1, WD2, WD3, WD6, WD7

MODEL 903.66 /67, 904.66

with CODE (H08) High-performance air conditioning

with CODE (ZU7) National version for Canada

MODEL 903.66 /67, 904.66

with CODE (H08) High-performance air conditioning

with CODE (ZU8) National version for USA

MODEL 903.66 /67, 904.66

with CODE (H08) High-performance air conditioning

with CODE (ZU9) National version for Mexico

PE83.30-D-2001-99H	Wiring diagram of climate control		PE83.30-D-2001-99H
PE83.30-D-2001-60H	Legend of wiring diagram of climate control		PE83.30-D-2001-60H
OV00.01-N-1901-03D	Use of wiring diagrams		OV00.01-N-1901-03D
OV00.01-N-1901E	Search aid for all wiring diagram groups		OV00.01-N-1901E
OV00.01-N-1001-27E	Abbreviations for wiring diagrams		OV00.01-N-1001-27E
GF00.19-D-2000D	Arrangement and assignment of ground points		GF00.19-D-2000D
GF00.19-D-3100-69A	Arrangement and assignment of climate control terminal blocks		GF00.19-D-3100-69A

PE54.25-D-2200C	Wiring diagram combination switch at electrical center, interior circuit	19.2.01
------------------------	---	----------------

MODELSXD1, XD2, XD3, XD4, XD5, XD6, XD7, YD1, YD2, YD3, YD4, YD5, YD6, YD7, WD1, WD2, WD3, WD6, WD7

MODELS903.61 /66 /67, 904.61 /66 with CODE (ZU7) National version for Canada

MODELS903.61 /66 /67, 904.61 /66 with CODE (ZU8) National version for USA

MODELS903.61 /62 /66 /67, 904.61 /62 /66 with CODE (ZU9) National version for Mexico

PE54.25-D-2200-99C	Wiring diagram combination switch at electrical center, interior circuit		PE54.25-D-2200-99C
PE54.25-D-2200-60C	Legend of wiring diagram of combination switch at electrical center, interior circuit		PE54.25-D-2200-60C
OV00.01-N-1901-03D	Use of wiring diagrams		OV00.01-N-1901-03D
OV00.01-N-1901E	Search aid for all wiring diagram groups		OV00.01-N-1901E
OV00.01-N-1001-27E	Abbreviations for wiring diagrams		OV00.01-N-1001-27E
GF00.19-D-2000D	Arrangement and assignment of ground points		GF00.19-D-2000D
GF00.19-D-3100-23C	Arrangement and assignment of terminal block connectors combination switch at electrical center interior circuit		GF00.19-D-3100-23C
PE07.00-D-1100D	Overview of wiring diagrams for mixture formation	Further wiring diagrams	PE07.00-D-1100D
PE15.00-D-1100D	Survey of wiring diagrams, electrical system, engine	Further wiring diagrams	PE15.00-D-1100D
PE82.00-D-1100D	Overview of wiring diagrams for electrical system, body	Further wiring diagrams	PE82.00-D-1100D
PE83.00-D-1100D	Overview of wiring diagrams for climate control	Further wiring diagrams	PE83.00-D-1100D

MODELSXD1, XD2, XD3, XD4, XD5, XD6, XD7, YD1, YD2, YD3, YD4, YD5, YD6, YD7, WD1, WD2, WD3, WD6, WD7

MODELS903.61 /66 /67, 904.61 /66

with CODE (L16) Halogen fog lamps
with CODE (ZU7) Canada national version

MODELS903.61 /66 /67, 904.61 /66

with CODE (L16) Halogen fog lamps
with CODE (ZU8) USA national version

MODELS903.61 /62 /66 /67, 904.61 /62 /66

with CODE (L16) Halogen fog lamps
with CODE (ZU9) Mexico national version

PE82.10-D-2501-99A	Wiring diagram of fog lights		PE82.10-D-2501-99A
PE82.10-D-2501-60A	Legend of wiring diagram of fog lights		PE82.10-D-2501-60A
OV00.01-N-1901-03D	Use of wiring diagrams		OV00.01-N-1901-03D
OV00.01-N-1901E	Search aid for all wiring diagram groups		OV00.01-N-1901E
OV00.01-N-1001-27E	Abbreviations for wiring diagrams		OV00.01-N-1001-27E
GF00.19-D-2000D	Arrangement and assignment of ground points		GF00.19-D-2000D
GF00.19-D-3100-68A	Arrangement and assignment of terminal block connectors, fog light		GF00.19-D-3100-68A

PE54.22-D-2000E	Wiring diagram for data link connector/diagnostic socket	19.2.01
------------------------	---	----------------

MODELSXD1, XD2, XD3, XD4, XD5, XD6, XD7, YD1, YD2, YD3, YD4, YD5, YD6, YD7, WD1, WD2, WD3, WD6, WD7

MODELS903.61 /66 /67, 904.61 /66 with CODE (ZU7) National version for Canada

MODELS903.61 /66 /67, 904.61 /66 with CODE (ZU8) National version for USA

MODELS903.61 /62 /66 /67, 904.61 /62 /66 with CODE (ZU9) National version for Mexico

PE54.22-D-2000-99E	Wiring diagram for data link connector/diagnostic socket		PE54.22-D-2000-99E
PE54.22-D-2000-60E	Legend of wiring diagram for data link connector / diagnostic socket		PE54.22-D-2000-60E
OV00.01-N-1901-03D	Use of wiring diagrams		OV00.01-N-1901-03D
OV00.01-N-1901E	Search aid for all wiring diagram groups		OV00.01-N-1901E
OV00.01-N-1001-27E	Abbreviations for wiring diagrams		OV00.01-N-1001-27E
GF00.19-D-2000D	Arrangement and assignment of ground points		GF00.19-D-2000D
GF00.19-D-3100-22C	Arrangement and assignment of terminal blocks of data link connector/diagnostic socket		GF00.19-D-3100-22C

MODELSXD1, XD2, XD3, XD4, XD5, XD6, XD7, YD1, YD2, YD3, YD4, YD5, YD6, YD7, WD1, WD2, WD3, WD6, WD7

MODELS903.61 /66 /67, 904.61 /66

with CODE (E77) Additional stereo speakers

with CODE (EF5) Radio Sound 10

with CODE (EF7) Radio Sound 30

with CODE (ZU7) Canada national version

MODELS903.61 /66 /67, 904.61 /66

with CODE (E77) Additional stereo speakers

with CODE (EF5) Radio Sound 10

with CODE (EF7) Radio Sound 30

with CODE (ZU8) USA national version

MODELS903.61 /62 /66 /67, 904.61 /62 /66

with CODE (EF5) Radio Sound 10

with CODE (ZU9) Mexico national version

PE82.60-D-2000-99E	Wiring diagram of radio		PE82.60-D-2000-99E
PE82.60-D-2000-60E	Legend for wiring diagram of radio		PE82.60-D-2000-60E
OV00.01-N-1901-03D	Use of wiring diagrams		OV00.01-N-1901-03D
OV00.01-N-1901E	Search aid for all wiring diagram groups		OV00.01-N-1901E
OV00.01-N-1001-27E	Abbreviations for wiring diagrams		OV00.01-N-1001-27E
GF00.19-D-2000D	Arrangement and assignment of ground points		GF00.19-D-2000D
GF00.19-D-3100-42C	Arrangement and assignment of terminal block connectors radio		GF00.19-D-3100-42C
PE82.00-D-1100D	Overview of wiring diagrams for electrical system, body	Further wiring diagrams	PE82.00-D-1100D

PE82.10-D-2200D	Wiring diagram turn signal/hazard warning lamps	19.2.01
------------------------	--	----------------

MODELSXD1, XD2, XD3, XD4, XD5, XD6, XD7, YD1, YD2, YD3, YD4, YD5, YD6, YD7, WD1, WD2, WD3, WD6, WD7

MODELS903.61 /66 /67, 904.61 /66 with CODE (ZU7) National version for Canada

MODELS903.61 /66 /67, 904.61 /66 with CODE (ZU8) National version for USA

MODELS903.61 /62 /66 /67, 904.61 /62 /66 with CODE (ZU9) National version for Mexico

PE82.10-D-2200-99D	Wiring diagram turn signal/hazard warning lamps		PE82.10-D-2200-99D
PE82.10-D-2200-60D	Legend for wiring diagram of turn signal/hazard warning lamps		PE82.10-D-2200-60D
OV00.01-N-1901-03D	Use of wiring diagrams		OV00.01-N-1901-03D
OV00.01-N-1901E	Search aid for all wiring diagram groups		OV00.01-N-1901E
OV00.01-N-1001-27E	Abbreviations for wiring diagrams		OV00.01-N-1001-27E
GF00.19-D-2000D	Arrangement and assignment of ground points		GF00.19-D-2000D
GF00.19-D-3100-38C	Arrangement and assignment of terminal block connectors turn signal/hazard warning lights		GF00.19-D-3100-38C
PE31.00-D-1100D	Survey of wiring diagrams of trailer coupling	Further wiring diagrams	PE31.00-D-1100D
PE80.00-D-1100D	Survey of wiring diagrams central locking, convenience hydraulics	Further wiring diagrams	PE80.00-D-1100D

PE82.30-D-2000D	Wiring diagram of windscreen wiper	19.2.01
------------------------	---	----------------

MODELSXD1, XD2, XD3, XD4, XD5, XD6, XD7, YD1, YD2, YD3, YD4, YD5, YD6, YD7, WD1, WD2, WD3, WD6, WD7

MODELS903.61 /66 /67, 904.61 /66 with CODE (ZU7) National version for Canada

MODELS903.61 /66 /67, 904.61 /66 with CODE (ZU8) National version for USA

MODELS903.61 /62 /66 /67, 904.61 /62 /66 with CODE (ZU9) National version for Mexico

PE82.30-D-2000-99D	Wiring diagram of windscreen wiper		PE82.30-D-2000-99D
PE82.30-D-2000-60D	Legend for wiring diagram of windshield wiper		PE82.30-D-2000-60D
OV00.01-N-1901-03D	Use of wiring diagrams		OV00.01-N-1901-03D
OV00.01-N-1901E	Search aid for all wiring diagram groups		OV00.01-N-1901E
OV00.01-N-1001-27E	Abbreviations for wiring diagrams		OV00.01-N-1001-27E
GF00.19-D-2000D	Arrangement and assignment of ground points		GF00.19-D-2000D

MODEL XD1, XD2, XD3, XD4, XD5, XD6, XD7, YD1, YD2, YD3, YD4, YD5, YD6, YD7, WD1, WD2, WD3, WD6, WD7

MODEL 903.61 /66 /67, 904.61 /66

with CODE (FM2) Tinted heated windshield with rain sensor

with CODE (ZU7) National version for Canada

MODEL 903.61 /66 /67, 904.61 /66

with CODE (FM2) Tinted heated windshield with rain sensor

with CODE (ZU8) National version for USA

MODEL 903.61 /62 /66 /67, 904.61 /62 /66

with CODE (FM2) Tinted heated windshield with rain sensor

with CODE (ZU9) National version for Mexico

PE82.30-D-2000-99F	Wiring diagram of windscreen wiper		PE82.30-D-2000-99F
PE82.30-D-2000-60F	windshield wiper		PE82.30-D-2000-60F
OV00.01-N-1901-03D	Use of wiring diagrams		OV00.01-N-1901-03D
OV00.01-N-1901E	Search aid for all wiring diagram groups		OV00.01-N-1901E
OV00.01-N-1001-27E	Abbreviations for wiring diagrams		OV00.01-N-1001-27E
GF00.19-D-2000D	Arrangement and assignment of ground points		GF00.19-D-2000D
PE54.00-D-1100D	Overview of wiring diagrams for electrical system, equipment and instruments	Further wiring diagrams	PE54.00-D-1100D

MODELSXD1, XD2, XD3, XD4, XD5, XD6, XD7, YD1, YD2, YD3, YD4, YD5, YD6, YD7, WD1, WD2, WD3, WD6, WD7

MODELS903.61 /66 /67, 904.61 /66

with CODE (LB1) Side marker lights

with CODE (ZU7) Canada national version

MODELS903.61 /66 /67, 904.61 /66

with CODE (LB1) Side marker lights

with CODE (ZU8) USA national version

MODELS903.61 /62 /66 /67, 904.61 /62 /66

with CODE (LB1) Side marker lights

with CODE (ZU9) Mexico national version

PE82.10-D-2400-99C	Wiring diagram for side marker lamps/end-outline marker lamps		PE82.10-D-2400-99C
PE82.10-D-2400-60C	Legend for wiring diagram of side marker/body outline lights		PE82.10-D-2400-60C
OV00.01-N-1901-03D	Use of wiring diagrams		OV00.01-N-1901-03D
OV00.01-N-1901E	Search aid for all wiring diagram groups		OV00.01-N-1901E
OV00.01-N-1001-27E	Abbreviations for wiring diagrams		OV00.01-N-1001-27E
GF00.19-D-2000D	Arrangement and assignment of ground points		GF00.19-D-2000D
GF00.19-D-3100-59B	Arrangement and assignment of terminal block connectors side marker/body outline lamps		GF00.19-D-3100-59B
PE82.00-D-1100D	Overview of wiring diagrams for electrical system, body	Further wiring diagrams	PE82.00-D-1100D

PE54.35-D-2000D	Wiring diagram signal system	19.2.01
------------------------	-------------------------------------	----------------

MODELSXD1, XD2, XD3, XD4, XD5, XD6, XD7, YD1, YD2, YD3, YD4, YD5, YD6, YD7, WD1, WD2, WD3, WD6, WD7

MODELS903.61 /66 /67, 904.61 /66 with CODE (ZU7) National version for Canada

MODELS903.61 /66 /67, 904.61 /66 with CODE (ZU8) National version for USA

MODELS903.61 /62 /66 /67, 904.61 /62 /66 with CODE (ZU9) National version for Mexico

PE54.35-D-2000-99D	Wiring diagram signal system		PE54.35-D-2000-99D
PE54.35-D-2000-60D	Legend for wiring diagram of signal system		PE54.35-D-2000-60D
OV00.01-N-1901-03D	Use of wiring diagrams		OV00.01-N-1901-03D
OV00.01-N-1901E	Search aid for all wiring diagram groups		OV00.01-N-1901E
OV00.01-N-1001-27E	Abbreviations for wiring diagrams		OV00.01-N-1001-27E
GF00.19-D-2000D	Arrangement and assignment of ground points		GF00.19-D-2000D
GF00.19-D-3100-25C	Arrangement and assignment of terminal block connectors signal system		GF00.19-D-3100-25C

MODELSXD1, XD2, XD3, XD4, XD5, XD6, XD7, YD1, YD2, YD3, YD4, YD5, YD6, YD7, WD1, WD2, WD3, WD6, WD7

MODELS903.61 /66 /67, 904.61 /66

with CODE (H15) Heater for front passenger seat

with CODE (H16) Heater for driver seat

with CODE (ZU7) National version for Canada

MODELS903.61 /66 /67, 904.61 /66

with CODE (H15) Heater for front passenger seat

with CODE (H16) Heater for driver seat

with CODE (ZU8) National version for USA

PE91.30-D-2000-99D	Wiring diagram of heated seats (HS)		PE91.30-D-2000-99D
PE91.30-D-2000-60D	Legend of wiring diagram heated seats (HS)		PE91.30-D-2000-60D
OV00.01-N-1901-03D	Use of wiring diagrams		OV00.01-N-1901-03D
OV00.01-N-1901E	Search aid for all wiring diagram groups		OV00.01-N-1901E
OV00.01-N-1001-27E	Abbreviations for wiring diagrams		OV00.01-N-1001-27E
GF00.19-D-2000D	Arrangement and assignment of ground points		GF00.19-D-2000D
GF00.19-D-3100-50C	Arrangement and assignment of terminal block connectors heated seats (HS)		GF00.19-D-3100-50C

PE15.00-D-2000R	Wiring diagram starter, alternator	19.2.01
------------------------	---	----------------

ENGINE612.981 in MODEL XD1, XD2, XD3, XD4, XD5, XD6, XD7, YD1, YD2, YD3, YD4, YD5, YD6, YD7, WD1, WD2, WD3, WD6, WD7

ENGINE612.981 in MODEL 903.61 /66 /67, 904.61 /66 with CODE (ZU7) National version for Canada

ENGINE612.981 in MODEL 903.61 /66 /67, 904.61 /66 with CODE (ZU8) National version for Canada

ENGINE, 612.981 in MODEL 903.61 /62 /66 /67, 904.61 /62 /66 with CODE (ZU9) National version for Mexico

PE15.00-D-2000-99R	Wiring diagram starter, alternator		PE15.00-D-2000-99R
PE15.00-D-2000-60R	Legend of wiring diagram starter, alternator		PE15.00-D-2000-60R
OV00.01-N-1901-03D	Use of wiring diagrams		OV00.01-N-1901-03D
OV00.01-N-1901E	Search aid for all wiring diagram groups		OV00.01-N-1901E
OV00.01-N-1001-27E	Abbreviations for wiring diagrams		OV00.01-N-1001-27E
GF00.19-D-2000D	Arrangement and assignment of ground points		GF00.19-D-2000D
GF00.19-D-3100-14C	Arrangement and assignment of terminal block connectors starter, alternator		GF00.19-D-3100-14C
PE00.19-D-1100D	Survey of wiring diagrams covering all function groups	Further wiring diagrams	PE00.19-D-1100D
PE82.00-D-1100D	Overview of wiring diagrams for electrical system, body	Further wiring diagrams	PE82.00-D-1100D

PE15.00-D-2000S	Wiring diagram starter, alternator	19.2.01
------------------------	---	----------------

ENGINE612.981 in MODEL YD1##, YD2##, YD3##, YD4##, YD5##, WD1##, WD2##, WD3## ### up to 313476 up to 31.8.01

ENGINE612.981 in MODEL 903.66# /67#, 904.66# ## up to 313476 up to 31.8.01

with CODE (E28) Additional battery, 12V/88Ah

with CODE (E36) Isolating relay

with CODE (ZU8) National version for USA

PE15.00-D-2000-99S	Wiring diagram starter, alternator		PE15.00-D-2000-99S
PE15.00-D-2000-60S	Legend of wiring diagram starter, alternator		PE15.00-D-2000-60S
OV00.01-N-1901-03D	Use of wiring diagrams		OV00.01-N-1901-03D
OV00.01-N-1901E	Search aid for all wiring diagram groups		OV00.01-N-1901E
OV00.01-N-1001-27E	Abbreviations for wiring diagrams		OV00.01-N-1001-27E
GF00.19-D-2000D	Arrangement and assignment of ground points		GF00.19-D-2000D
GF00.19-D-3100-14C	Arrangement and assignment of terminal block connectors starter, alternator		GF00.19-D-3100-14C

PE15.00-D-2000T	Wiring diagram starter, alternator	19.2.01
------------------------	---	----------------

ENGINE612.981 in MODEL YD1##, YD2##, YD3##, YD4##, YD5##, WD1##, WD2##, WD3## ### up to 313476 up to 31.8.01

ENGINE612.981 in MODEL 903.66# /67#, 904.66# ## up to 313476 up to 31.8.01

with CODE (E28) Additional battery, 12V/88Ah
with CODE (E36) Isolating relay
with CODE (M35) Alternator 14 V / 115 A with CODE
ZU8N National version for USA

PE15.00-D-2000-99T	Wiring diagram starter, alternator		PE15.00-D-2000-99T
PE15.00-D-2000-60T	Legend of wiring diagram starter, alternator		PE15.00-D-2000-60T
OV00.01-N-1901-03D	Use of wiring diagrams		OV00.01-N-1901-03D
OV00.01-N-1901E	Search aid for all wiring diagram groups		OV00.01-N-1901E
OV00.01-N-1001-27E	Abbreviations for wiring diagrams		OV00.01-N-1001-27E
GF00.19-D-2000D	Arrangement and assignment of ground points		GF00.19-D-2000D
GF00.19-D-3100-14C	Arrangement and assignment of terminal block connectors starter, alternator		GF00.19-D-3100-14C

ENGINE612.981

in MODEL XD1, XD2, XD3, XD4, XD5, XD6, XD7,
 YD1##, YD2##, YD3##, YD4##, YD5##, YD6##, YD7##, WD1##, WD2##, WD3##, WD6##, WD7##
 ### as of 313477 as of 3.9.01

ENGINE612.981 in MODEL 903.61 /66 /67, 904.61 /66

with CODE (E28) Additional battery, 12V/88Ah
 with CODE (E36) Isolating relay
 with CODE (ZU7) National version for Canada

ENGINE612.981 in MODEL 903.61# /66# /67#, 904.61# /66# ## as of 313477 as of 3.9.01

with CODE (E28) Additional battery, 12V/88Ah
 with CODE (E36) Isolating relay
 with CODE (ZU8) National version for USA

ENGINE612.981 in MODEL 903.61 /62 /66 /67, 904.61 /62 /66

with CODE (E28) Additional battery, 12V/88Ah
 with CODE (E36) Isolating relay
 with CODE (ZU9) National version for Mexico

PE15.00-D-2000-99U	Wiring diagram starter, alternator		PE15.00-D-2000-99U
PE15.00-D-2000-60U	Legend of wiring diagram starter, alternator		PE15.00-D-2000-60U
OV00.01-N-1901-03D	Use of wiring diagrams		OV00.01-N-1901-03D
OV00.01-N-1901E	Search aid for all wiring diagram groups		OV00.01-N-1901E
OV00.01-N-1001-27E	Abbreviations for wiring diagrams		OV00.01-N-1001-27E
GF00.19-D-2000D	Arrangement and assignment of ground points		GF00.19-D-2000D
GF00.19-D-3100-14C	Arrangement and assignment of terminal block connectors starter, alternator		GF00.19-D-3100-14C

PE15.00-D-2000W	Wiring diagram starter, alternator	23.6.03
------------------------	---	----------------

ENGINE647.981 in MODEL XD1, XD2, XD3, XD4, XD5, XD6, XD7, YD1, YD2, YD3, YD4, YD5, YD6, YD7, WD1, WD2, WD3, WD6, WD7

ENGINE647.981 in MODEL 903.61 /66 /67, 904.61 /66 with CODE (ZU7) National version for Canada

ENGINE647.981 in MODEL 903.61 /66 /67, 904.61 /66 with CODE (ZU8) National version for Canada

ENGINE, 647.981 in MODEL 903.61 /62 /66 /67, 904.61 /62 /66 with CODE (ZU9) National version for Mexico

PE15.00-D-2000-99W	Wiring diagram starter, alternator		PE15.00-D-2000-99W
PE15.00-D-2000-60W	Legend of wiring diagram starter, alternator		PE15.00-D-2000-60W
OV00.01-N-1901-03D	Use of wiring diagrams		OV00.01-N-1901-03D
OV00.01-N-1901E	Search aid for all wiring diagram groups		OV00.01-N-1901E
OV00.01-N-1001-27E	Abbreviations for wiring diagrams		OV00.01-N-1001-27E
GF00.19-D-2000D	Arrangement and assignment of ground points		GF00.19-D-2000D
GF00.19-D-3100-14C	Arrangement and assignment of terminal block connectors starter, alternator		GF00.19-D-3100-14C
PE00.19-D-1100D	Survey of wiring diagrams covering all function groups	Further wiring diagrams	PE00.19-D-1100D
PE82.00-D-1100D	Overview of wiring diagrams for electrical system, body	Further wiring diagrams	PE82.00-D-1100D

MODELSXD1, XD2, XD3, XD4, XD5, XD6, XD7, YD1, YD2, YD3, YD4, YD5, YD6, YD7, WD1, WD2, WD3, WD6, WD7

MODELS903.61 /66 /67, 904.61 /66

with CODE (EK1) Terminal strip for electrical connection at driver seat frame

with CODE (ES5) 12V socket in instrument panel

with CODE (ZU7) Canada national version

MODELS903.61 /66 /67, 904.61 /66

with CODE (EK1) Terminal strip for electrical connection at driver seat frame

with CODE (ES5) 12V socket in instrument panel

with CODE (ZU8) USA national version

MODELS903.61 /62 /66 67, 904.61 62 /66

with CODE (EK1) Terminal strip for electrical connection at driver seat frame

with CODE (ES5) 12V socket in instrument panel

with CODE (ZU9) Mexico national version

PE82.00-D-2500-99C	Wiring diagram interior sockets		PE82.00-D-2500-99C
PE82.00-D-2500-60C	Legend for electric wiring diagram of sockets in interior		PE82.00-D-2500-60C
OV00.01-N-1901-03D	Use of wiring diagrams		OV00.01-N-1901-03D
OV00.01-N-1901E	Search aid for all wiring diagram groups		OV00.01-N-1901E
OV00.01-N-1001-27E	Abbreviations for wiring diagrams		OV00.01-N-1001-27E
GF00.19-D-2000D	Arrangement and assignment of ground points		GF00.19-D-2000D
GF00.19-D-3100-35C	Arrangement and assignment of terminal block connectors interior sockets		GF00.19-D-3100-35C

PE82.10-D-2100F	Wiring diagram of daytime running lights	19.2.01
------------------------	---	----------------

MODELSXD1, XD2, XD3, XD4, XD5, XD6, XD7, YD1, YD2, YD3, YD4, YD5, YD6, YD7, WD1, WD2, WD3, WD6, WD7

MODELS903.61 /66 /67, 904.61 /66

with CODE (L05) Automatic daytime running lamps

with CODE (ZU7) Canada national version

MODELS903.61 /66 /67, 904.61 /66

with CODE (L05) Automatic daytime running lamps

with CODE (ZU8) USA national version

PE82.10-D-2100-99F	Wiring diagram of daytime running lights		PE82.10-D-2100-99F
PE82.10-D-2100-60F	Electric circuit wiring diagram legend daytime dipped headlight		PE82.10-D-2100-60F
OV00.01-N-1901-03D	Use of wiring diagrams		OV00.01-N-1901-03D
OV00.01-N-1901E	Search aid for all wiring diagram groups		OV00.01-N-1901E
OV00.01-N-1001-27E	Abbreviations for wiring diagrams		OV00.01-N-1001-27E
GF00.19-D-2000D	Arrangement and assignment of ground points		GF00.19-D-2000D
GF00.19-D-3100-37D	Arrangement and assignment of terminal block connectors daytime running lamps		GF00.19-D-3100-37D

PE82.70-D-2000D	Telephone (TEL) wiring diagram	19.2.01
------------------------	---------------------------------------	----------------

MODEL XD1, XD2, XD3, XD4, XD5, XD6, XD7, YD1, YD2, YD3, YD4, YD5, YD6, YD7, WD1, WD2, WD3, WD6, WD7

MODEL 903.61 /66 /67, 904.61 /66

with CODE (JV4) Preinstallation portable cellular telephone

with CODE (EV7) Preinstallation for hands-free system

with CODE (ZU7) National version for Canada

MODEL 903.61 /66 /67, 904.61 /66

with CODE (JV4) Preinstallation portable cellular telephone

with CODE (EV7) Preinstallation for hands-free system

with CODE (ZU8) National version for USA

PE82.70-D-2000-99D	Telephone (TEL) wiring diagram		PE82.70-D-2000-99D
PE82.70-D-2000-60D	Legend for wiring diagram of telephone (CTEL)		PE82.70-D-2000-60D
OV00.01-N-1901-03D	Use of wiring diagrams		OV00.01-N-1901-03D
OV00.01-N-1901E	Search aid for all wiring diagram groups		OV00.01-N-1901E
OV00.01-N-1001-27E	Abbreviations for wiring diagrams		OV00.01-N-1001-27E
GF00.19-D-2000D	Arrangement and assignment of ground points		GF00.19-D-2000D
GF00.19-D-3100-43C	Arrangement and assignment of terminal block connectors cellular telephone (CTEL)		GF00.19-D-3100-43C

PE80.20-D-2000F	Wiring diagram of central locking (CL)	19.2.01
------------------------	---	----------------

MODEL XD1, XD2, XD3, XD4, XD5, XD6, XD7, YD1, YD2, YD3, YD4, YD5, YD6, YD7, WD1, WD2, WD3, WD6, WD7

MODEL 903.61 /66 /67, 904.61 /66

with CODE (FY6) Central locking with radio frequency locking

with CODE (ZU7) National version for Canada

MODEL 903.61 /66 /67, 904.61 /66

with CODE (FY6) Central locking with radio frequency locking

with CODE (ZU8) National version for USA

MODEL 903.61 /62 /66 /67, 904.61 /62 /66

with CODE (FY6) Central locking with radio frequency locking

with CODE (ZU9) National version for Mexico

PE80.20-D-2000-99F	Wiring diagram of central locking (CL)		PE80.20-D-2000-99F
PE80.20-D-2000-60F	Legend for wiring diagram of central locking (CL)		PE80.20-D-2000-60F
OV00.01-N-1901-03D	Use of wiring diagrams		OV00.01-N-1901-03D
OV00.01-N-1901E	Search aid for all wiring diagram groups		OV00.01-N-1901E
OV00.01-N-1001-27E	Abbreviations for wiring diagrams		OV00.01-N-1001-27E
GF00.19-D-2000D	Arrangement and assignment of ground points		GF00.19-D-2000D
GF00.19-D-3100-30C	Arrangement and assignment of terminal block connectors central locking (CL)		GF00.19-D-3100-30C
PE54.00-D-1100D	Overview of wiring diagrams for electrical system, equipment and instruments	Further wiring diagrams	PE54.00-D-1100D
PE91.00-D-1100D	Overview of wiring diagrams for seats, bunks, restraint systems	Further wiring diagrams	PE91.00-D-1100D

MODELSYD1##, YD2##, YD3##, YD4##, YD5##, YD6##, YD7##, WD1##, WD2##, WD3##, WD6##, WD7##
 ### as of 382002 as of 3/12/02
 MODELS903.66 /67, 904.66

with CODE (H11) Warm air auxiliary heater
 with CODE (ZU7) National version for Canada

MODELS903.66# /67#, 904.66# ## as of 382002 as of 3/12/02

with CODE (H11) Warm air auxiliary heater
 with CODE (ZU8) National version for USA
 Heater unit designation AIRTRONIC D4

PE83.70-D-2001-99LA	Wiring diagram of auxiliary heater (ZHE)		PE83.70-D-2001-99LA
PE83.70-D-2001-60LA	Legend of wiring diagram of auxiliary heater (ACH)		PE83.70-D-2001-60LA
OV00.01-N-1901-03D	Use of wiring diagrams		OV00.01-N-1901-03D
OV00.01-N-1901E	Search aid for all wiring diagram groups		OV00.01-N-1901E
OV00.01-N-1001-27E	Abbreviations for wiring diagrams		OV00.01-N-1001-27E
GF00.19-D-2000D	Arrangement and assignment of ground points		GF00.19-D-2000D
GF00.19-D-3100-47I	Arrangement and assignment of terminal block connectors auxiliary heater (ZHE)		GF00.19-D-3100-47I
PE80.00-D-1100D	Survey of wiring diagrams central locking, convenience hydraulics	Further wiring diagrams	PE80.00-D-1100D

PE83.70-D-2001S	Wiring diagram of auxiliary heater (ZHE)	19.2.01
------------------------	---	----------------

MODELS YD1##, YD2##, YD3##, YD4##, YD5##, WD1##, WD2##, WD3## ### up to 382001 up to 3/11/02
MODELS 903.66# /67#, 904.66# ## up to 382001 up to 3/11/02
with CODE (H11) Warm air auxiliary heater
with CODE (ZU8) National version for USA
Heater unit designation D3L-C compact

PE83.70-D-2001-99S	Wiring diagram of auxiliary heater (ZHE)		PE83.70-D-2001-99S
PE83.70-D-2001-60S	Legend of wiring diagram of auxiliary heater (ACH)		PE83.70-D-2001-60S
OV00.01-N-1901-03D	Use of wiring diagrams		OV00.01-N-1901-03D
OV00.01-N-1901E	Search aid for all wiring diagram groups		OV00.01-N-1901E
OV00.01-N-1001-27E	Abbreviations for wiring diagrams		OV00.01-N-1001-27E
GF00.19-D-2000D	Arrangement and assignment of ground points		GF00.19-D-2000D
GF00.19-D-3100-47I	Arrangement and assignment of terminal block connectors auxiliary heater (ZHE)		GF00.19-D-3100-47I
PE80.00-D-1100D	Survey of wiring diagrams central locking, convenience hydraulics	Further wiring diagrams	PE80.00-D-1100D

PE83.70-D-2001T	Wiring diagram of auxiliary heater (ZHE)	19.2.01
------------------------	---	----------------

MODELSXD1, XD2, XD3, XD4, XD5, XD6, XD7, YD1, YD2, YD3, YD4, YD5, YD6, YD7, WD1, WD2, WD3, WD6, WD7

MODELS903.61 /66 /67, 904.61 /66

with CODE (HZ9) Heater booster, diesel engine

with CODE (ZU7) National version for Canada

MODELS903.61 /66 /67, 904.61 /66

with CODE (HZ9) Heater booster, diesel engine

with CODE (ZU8) National version for USA

PE83.70-D-2001-99T	Wiring diagram of auxiliary heater (ZHE)		PE83.70-D-2001-99T
PE83.70-D-2001-60T	Legend of wiring diagram of auxiliary heater (ACH)		PE83.70-D-2001-60T
OV00.01-N-1901-03D	Use of wiring diagrams		OV00.01-N-1901-03D
OV00.01-N-1901E	Search aid for all wiring diagram groups		OV00.01-N-1901E
OV00.01-N-1001-27E	Abbreviations for wiring diagrams		OV00.01-N-1001-27E
GF00.19-D-2000D	Arrangement and assignment of ground points		GF00.19-D-2000D
GF00.19-D-3100-47K	Arrangement and assignment of terminal block connectors auxiliary heater (ZHE)		GF00.19-D-3100-47K

MODEL YD1, YD2, YD3, YD4, YD5, YD6, YD7, WD1, WD2, WD3, WD6, WD7
 MODELS 903.66 /67, 904.66
 with CODE (H13) Auxiliary heat exchanger in cargo area
 with CODE (ZU7) National version for Canada

MODELS 903.66 /67, 904.66
 with CODE (H13) Auxiliary heat exchanger in cargo area
 with CODE (ZU8) National version for USA

MODELS 903.66 /67, 904.66
 with CODE (H13) Auxiliary heat exchanger in cargo area
 with CODE (ZU9) National version for Mexico

PE83.70-D-2001-99U	Wiring diagram of auxiliary heater (ZHE)		PE83.70-D-2001-99U
PE83.70-D-2001-60U	Legend of wiring diagram of auxiliary heater (ACH)		PE83.70-D-2001-60U
OV00.01-N-1901-03D	Use of wiring diagrams		OV00.01-N-1901-03D
OV00.01-N-1901E	Search aid for all wiring diagram groups		OV00.01-N-1901E
OV00.01-N-1001-27E	Abbreviations for wiring diagrams		OV00.01-N-1001-27E
GF00.19-D-2000D	Arrangement and assignment of ground points		GF00.19-D-2000D
GF00.19-D-3100-47K	Arrangement and assignment of terminal block connectors auxiliary heater (ZHE)		GF00.19-D-3100-47K

MODELSXD1, XD2, XD3, XD4, XD5, XD6, XD7, YD1, YD2, YD3, YD4, YD5, YD6, YD7, WD1, WD2, WD3, WD6, WD7

MODELS903.61 /66 /67, 904.61 /66

with CODE (H12) Hot water auxiliary heater
with CODE (H86) Timer for auxiliary heater
with CODE (ZU7) National version for Canada

MODELS903.61 /66 /67, 904.61 /66

with CODE (H12) Hot water auxiliary heater
with CODE (H86) Timer for auxiliary heater
with CODE (ZU8) National version for USA

MODELS903.61 /62 /66 /67, 904.61 /62 /66

with CODE (H12) Hot water auxiliary heater
with CODE (H86) Timer for auxiliary heater
with CODE (ZU9) National version for Mexico
Heater unit designation D5WS

PE83.70-D-2001-99V	Wiring diagram of auxiliary heater (ZHE)		PE83.70-D-2001-99V
PE83.70-D-2001-60V	Legend of wiring diagram of auxiliary heater (ACH)		PE83.70-D-2001-60V
OV00.01-N-1901-03D	Use of wiring diagrams		OV00.01-N-1901-03D
OV00.01-N-1901E	Search aid for all wiring diagram groups		OV00.01-N-1901E
OV00.01-N-1001-27E	Abbreviations for wiring diagrams		OV00.01-N-1001-27E
GF00.19-D-2000D	Arrangement and assignment of ground points		GF00.19-D-2000D
GF00.19-D-3100-47J	Arrangement and assignment of terminal block connectors auxiliary heater (ZHE)		GF00.19-D-3100-47J
PE54.00-D-1100D	Overview of wiring diagrams for electrical system, equipment and instruments	Further wiring diagrams	PE54.00-D-1100D
PE83.00-D-1100D	Overview of wiring diagrams for climate control	Further wiring diagrams	PE83.00-D-1100D

GF00.19-D-2000-07D	Arrangement and assignment of ground points	<p>Models XD1, XD2, XD3, XD4, XD5, XD6, XD7, YD1, YD2, YD3, YD4, YD5, YD6, YD7, WD1, WD2, WD3, WD6, WD7</p> <p>Models 903.61/66/67, 904.61/66 with code (ZU7) National version for Canada</p> <p>Models 903.61/66/67, 904.61/66 with code (ZU8) National version for USA</p> <p>Models 903.61/62/66/67, 904.61/62/66 with code (ZU9) National version for Mexico</p>	
--------------------	---	--	--

Ground point	Designation	Wiring harness	
W2	Ground point right headlamp	Frame	
W2.1	Ground point ATA, right headlamp	Frame	
W4	Firewall ground point	Frame	
W5	Seat frame ground point	Frame	
W6	Ground point taillamp	Frame	
W7	Engine compartment ground point	Frame	
W8	Ground point waistrail	Wastrail	
W15	Ground point engine	Engine	
W26	Ground point airbag	Frame	
W27	Ground point ABS	Frame	
W41	Roof AC ground point	Roof	

GF00.19-D-2000-08D	Assignment of ground points	<p>Models XD1, XD2, XD3, XD4, XD5, XD6, XD7, YD1, YD2, YD3, YD4, YD5, YD6, YD7, WD1, WD2, WD3, WD6, WD7</p> <p>Models 903.61/66/67, 904.61/66 with code (ZU7) National version for Canada</p> <p>Models 903.61/66/67, 904.61/66 with code (ZU8) National version for USA</p> <p>Models 903.61/62/66/67, 904.61/62/66 with code (ZU9) National version for Mexico</p>	
--------------------	-----------------------------	--	--

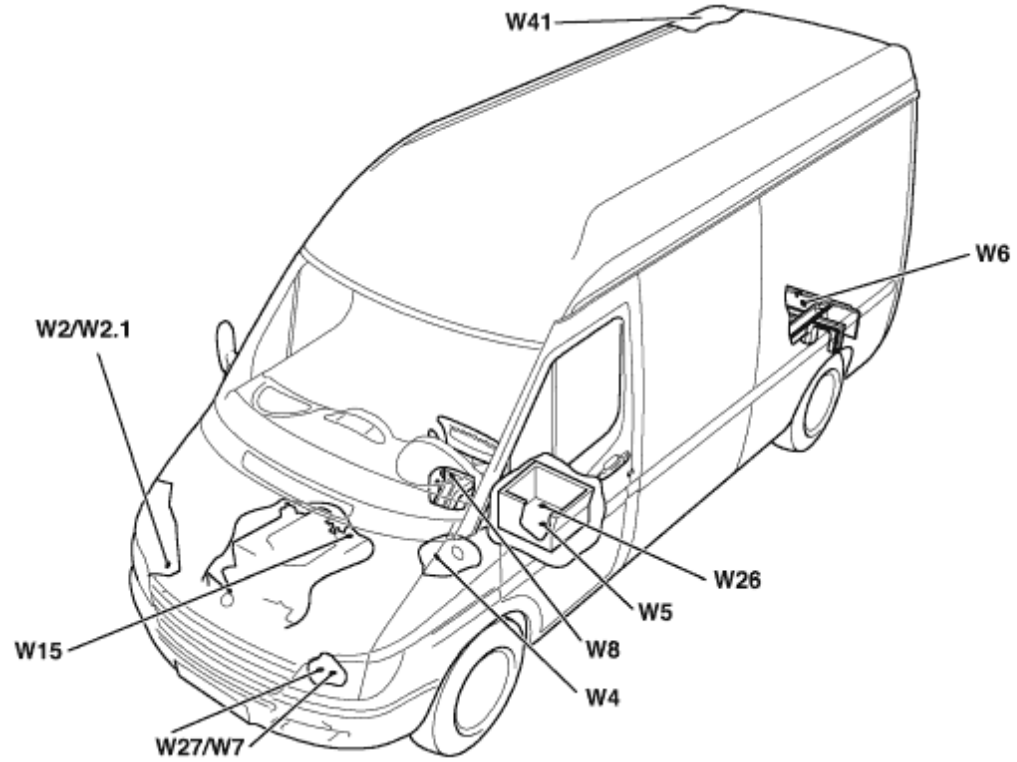

D00.19-1352-09

Ground point	Designation		Component	Designation	Connector Pin
W2	Ground point right headlamp	→	E26	Right headlamp	3 4 8
		→	H2	Right front side turn signal lamp (5	2

				W)	
		→	H9	Right front side turn signal lamp (21 W)	2
		→	M6	Windscreen washer system pump	1
		→	M58	Washer fluid pump with level indicator	2
W2.1	Ground point ATA, right headlamp	→	S18	EDW (hood) contact switch	3
W4	Firewall ground point	→	A12	Electrical center	3.4
		→	A62	WSP control unit	2
		→	A80	CDI control unit	1.4 1.5 1.6
		→	B54	Brake fluid switch LHS	2
		→	G2	Battery	
		→	G5	Left front brake wear indicator sensor	1
		→	G6	Right front brake wear indicator sensor	1
		→	H78	Battery-operated horn	2
		→	K77	Air conditioning additional fan relay	4
		→	M4x1	Front end blower LHS	2
		→	M7	Windscreen wiper motor LHS	1
		→	M51	Circulating pump	2
		→	P15	Instrument cluster	2.6
		→	P17	Diagnostic socket 16-pin	4 5
		→	S45X1	Driver door lock switch connector	3
		→	S139	Ignition lock switch	1
		→	X45	Frame/roof connector (standard)	6
		→	X113	Horn clock spring contact connector	1
		→	Y37	Water cycle valve	2
W5	Seat frame ground point	→	A4	ETC control unit	1.30
		→	A8	Central locking control unit	1.14
		→	A82	EDW control unit	1.16
		→	A93	Trailer socket control unit	2.C
		→	E2	Left front side marker lamp	2

	→	E3	Right front side marker lamp	2
	→	E13	Left center side marker lamp	2
	→	E14	Right center side marker lamp	2
	→	E28	Left front side marker lamp	2
	→	E101	Right front side marker lamp	2
	→	G9	Additional battery	
	→	K3	Heated rear window relay	7
	→	K26	Circuit D+ relay	3 4
	→	K37	Horn relay	5
	→	K52	Additional battery cut-off relay	1.2
	→	K53	Additional heavy-duty battery isolating relay	1.2
	→	K54	Interior lighting stepping relay	7
	→	K58	Additional heat exchanger relay	2
	→	K68	Daytime running lamps relay	4
	→	K69	Daytime running lamps relay	4
	→	K70	Circuit 15 relay for optional equipment	4
	→	K75	Warm water heater fan stage 1 relay	4
	→	K78	Circuit D+ body manufacturer relay	2
	→	K79	Circuit 15 body manufacturer relay	2
	→	K86	Right heated rear window relay, ATA [EDW]	2
	→	K87	Left heated rear window relay, ATA [EDW]	2
	→	K103	Circulation pump relay	B
	→	K135	Daytime running lamps terminal 58L relay	4
	→	K136	Daytime running lamps terminal 58R relay	4
	→	K138	Circuit 15 relay	4
	→	K140	Daytime running lamps relay	4
	→	K142	Fog lights relay	4
	→	R30	Left seat heater	4
	→	R31	Right seat heater	4

		→	S76	Seat belt buckle switch	1
		→	S80	Parking brake switch	2
		→	X5.1	Additional heater connector LHS	4
		→	X119	Side marker lamp connector	1
		→	X189	Additional heat exchanger connector	A
W6	Ground point taillamp	→	E15	Left rear side marker lamp	2
		→	E16	Right rear side marker lamp	2
		→	E67	Left rear lamp	1 6
		→	E68	Right rear lamp	1 6
		→	J39	Brake wear indicator ground connector sleeve	
		→	X26	Left rear license plate lighting contact plate 2-pin	2
		→	X32	Right rear, rear window defroster contact plate, 2-pin	2
		→	X34	Right rear contact plate 3-pin	6
		→	X232	Trailer socket connector	8
W7	Engine compartment ground point	→	A2	ABS/ESP control unit	1.1
		→	B7	Coolant level switch	2
		→	D4	Glow time output stage	1.1
		→	E25	Left headlamp	3 4 8
		→	H5	Left front side turn signal lamp (5 W)	2
		→	H10	Left front side turn signal lamp (21 W)	2
		→	M45	Air conditioning additional fan	2
		→	M54	Metering pump	2
		→	M61	Metering pump	2
		→	X165	Warm water auxiliary heater connector, 8-pin	2
		→	Y8	Differential lock solenoid valve	2
W8	Ground point waistrail	→	A9	Radio	1.A8
		→	A40	EWM control unit	4

		→	A81	Air conditioning pushbutton control and operating unit	1.15
		→	E17	Cigarette lighter	1
		→	E104	Ashtray lighting	3
		→	J302	Tml. 31 connector sleeve	
		→	M12.1	Front passenger mirror adjustment connector	2
		→	S12	Driver seat heater switch	3 10
		→	S25	Headlamp range adjustment switch	3
		→	S48	ASR switch	10
		→	S57	Differential lock switch	10
		→	S81	Rear window defroster pushbutton	10
		→	S85	Driver interior lighting pushbutton	10
		→	S87	Auxiliary heater switch	10
		→	S90	Roof fan switch	5 6 10
		→	S92	Panic alarm button	3 10
		→	S99	ATA [EDW] towing/interior motion sensor button	4 10
		→	S100	Additional heat exchanger double-contact pushbutton	5 10
		→	S107	Front passenger seat heater switch	5 10
		→	S119.1	Fog light switch	10
		→	S126	Interior pushbutton	7 10
		→	S137	Roof AC switch	10
		→	X201	Right mirror adjustment connector	1
		→	X202	Power window switch connector (driver door)	1
		→	X214	Portable CTEL preinstallation, mute function connector	1
		→	X233	Instrument panel socket	1
W15	Ground point engine	→	R41	Crankcase breather heater	
W26	Ground point airbag	→	A10	Airbag control unit	1.6

					2
W27	Ground point ABS	→	A2	ABS/ESP control unit	1.5
W41	Roof AC ground point	→	X220	Roof AC plug connection	1

MODELS 903.662 with CODE (ZA8) Refrigerator vehicle

MODELS 903.662 with CODE (ZA5) Freezer vehicle

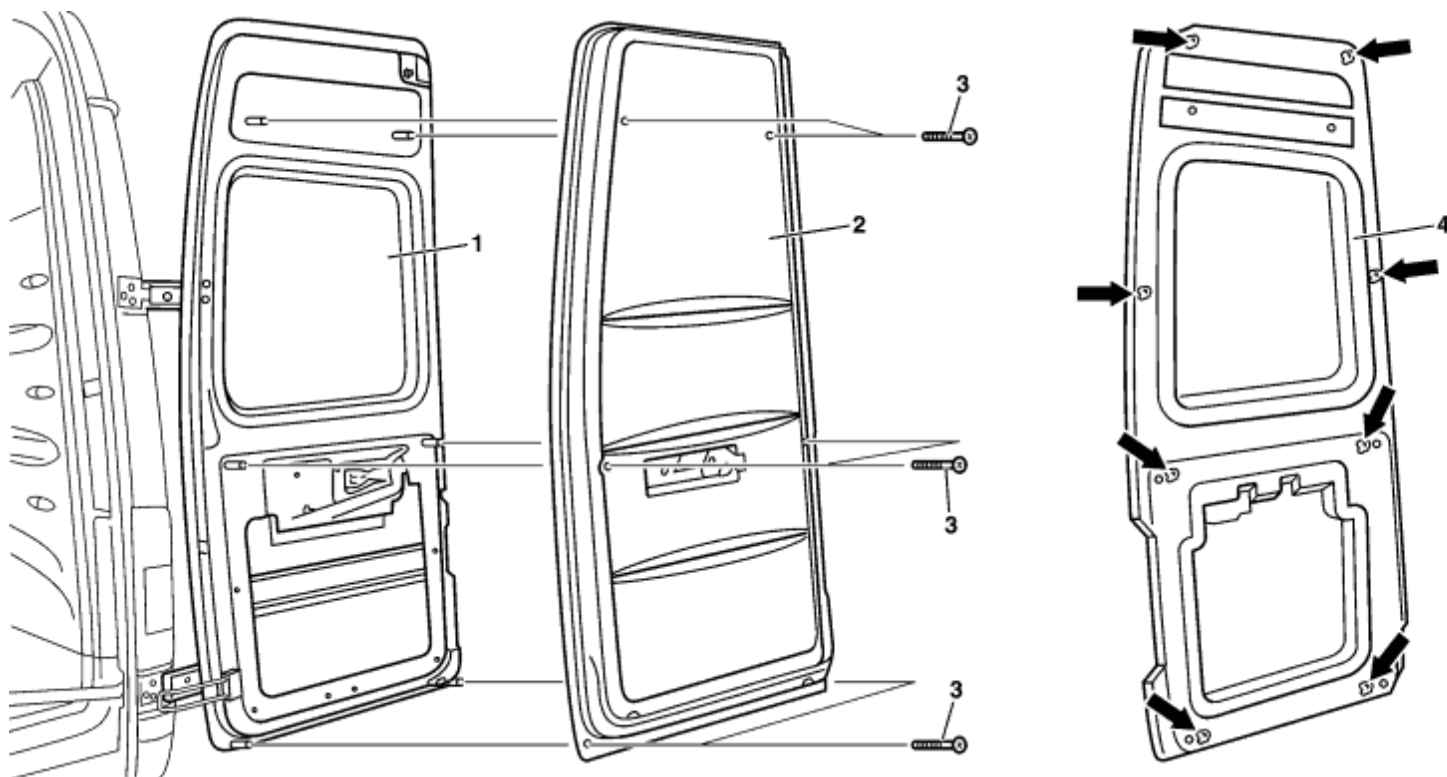



D83.65-0043-09



1 Tailgate

2 Front side of insulation element

3 Screw

4 Rear side of insulation element

	Remove		
1	Remove inside door opener	on right rear-end door only	AR72.20-D-4075A
2	Expose bolts (3) of insulating element (2)	 Remove sealing compound on bolt heads.	
3	Separate edge sealing between insulation element (2) and rear-end door (1) all-round		
4	Separate insulation element from rear-end door	 Do not damage insulation foam on rear of insulation element. Carefully cut through adhesive points (4 in area of lower bolt holes and 4 at top of outer door contact surface).	
5	Remove residue adhesive on		

	rear door and on insulation element		
	Install		
6	On the rear of the insulation element in the area of the outer door contact surface apply at 8 points walnut-sized dots of sealing compound (arrows)	 The sealing compound dots serve as adhesive points. Apply sealing compound dots at the lower end of the insulation element in area of the 4 bolt holes.	BR00.45-Z-1079-01A
7	Apply insulation element (2) to rear-end door (1) and tighten	 When fitting the insulation element on the right-hand rear door route the door lock linkage outwards.	
8	Cover up bolt heads using sealing compound		BR00.45-Z-1079-01A
9	Apply sealing compound to gap between insulation element and rear door all round		BR00.45-Z-1079-01A
10	Install inside door opener	on right rear-end door only	AR72.20-D-4075A

Auxiliary repair materials

Number	Designation	Order number
BR00.45-Z-1079-01A	PU sealing compound, white	A 004 989 34 20

PE91.00-D-2000-99D

[Display in a separate window](#)

To display wiring diagrams, you need a
JAVA 1.1 capable Browser like e.g. "Microsoft Internet Explorer 4.0"
or
"Netscape Navigator 4.05" and higher with AWT 1.1 support

- A8 Central locking control module
- A10 Airbag control module
- A10 Airbag control module
- A80 CDI control module
- A94 CDI control module
- J18 Circuit 15, fused, connector sleeve
- J371 Airbag crash signal connector sleeve
- P15 Instrument cluster
- P17 Diagnostic socket 16-pin
- R1 Driver airbag ignition squib
- R2 Front passenger airbag ignition squib
- R3 Driver ETR ignition squib
- R4 Front passenger ETR ignition squib
- R5 Clock spring contact
- W26 Ground point airbag
- X125 Airbag clock spiral connector
- X126 Front passenger airbag ignition squib connector

PE91.00-D-2000-60D	Legend of wiring diagram of airbag (AB), emergency tensioning retractor (ETR)	<p>MODEL XD1, XD2, XD3, XD4, XD5, XD6, XD7, YD1, YD2, YD3, YD4, YD5, YD6, YD7, WD1, WD2, WD3, WD6, WD7</p> <p>MODELS 903.61 /66 /67, 904.61 /66 with CODE (SA5) Driver airbag with CODE (SA6) Front passenger airbag with CODE (ZU7) National version for Canada</p> <p>MODELS 903.61 /66 /67, 904.61 /66 with CODE (SA5) Driver airbag with CODE (SA6) Front passenger airbag with CODE (ZU8) National version for USA</p> <p>MODELS 903.61 /62 /66 /67, 904.61 /62 /66 with CODE (SA5) Driver airbag with CODE (SA6) Front passenger airbag with CODE (ZU9) National version for Mexico</p>	
--------------------	---	---	--

Code	Designation	Coordinate
A8	Central locking control unit	8L
A10	Airbag control unit	4A 12A
A80	CDI control unit	5L
A94	CDI control unit	7L
J18	Circuit 15 fused connector sleeve	3E
J371	Airbag crash signal connector sleeve	8E
P15	Instrument cluster	2L
P17	Diagnostic socket 16-pin	4E
R1	Driver airbag ignition squib	9L
R2	Front passenger airbag ignition squib	11L
R3	Driver ETR ignition squib	12L

R4	Front passenger ETR ignition squib	13L
R5	Clock spring contact	9G
W26	Ground point airbag	2E
X125	Airbag clock spring contact connector	8E
X126	Front passenger airbag ignition squib connector	10E

GF00.19-D-3100-49C

Arrangement and assignment of terminal blocks of airbag (AB), emergency tensioning retractor (ETR)

Models XD1, XD2, XD3, XD4, XD5, XD6, XD7, YD1, YD2, YD3, YD4, YD5, YD6, YD7, WD1, WD2, WD3, WD6, WD7
Models 903.61/66/67, 904.61/66
with code (SA5) Driver airbag
with code (SA6) Front passenger airbag
with code (ZU7) National version for Canada
Models 903.61/66/67, 904.61/66
with code (SA5) Driver airbag
with code (SA6) Front passenger airbag
with code (ZU8) National version for USA
Models 903.61/62/66/67, 904.61/62/66
with code (SA5) Driver airbag
with code (SA6) Front passenger airbag
with code (ZU9) National version for Mexico

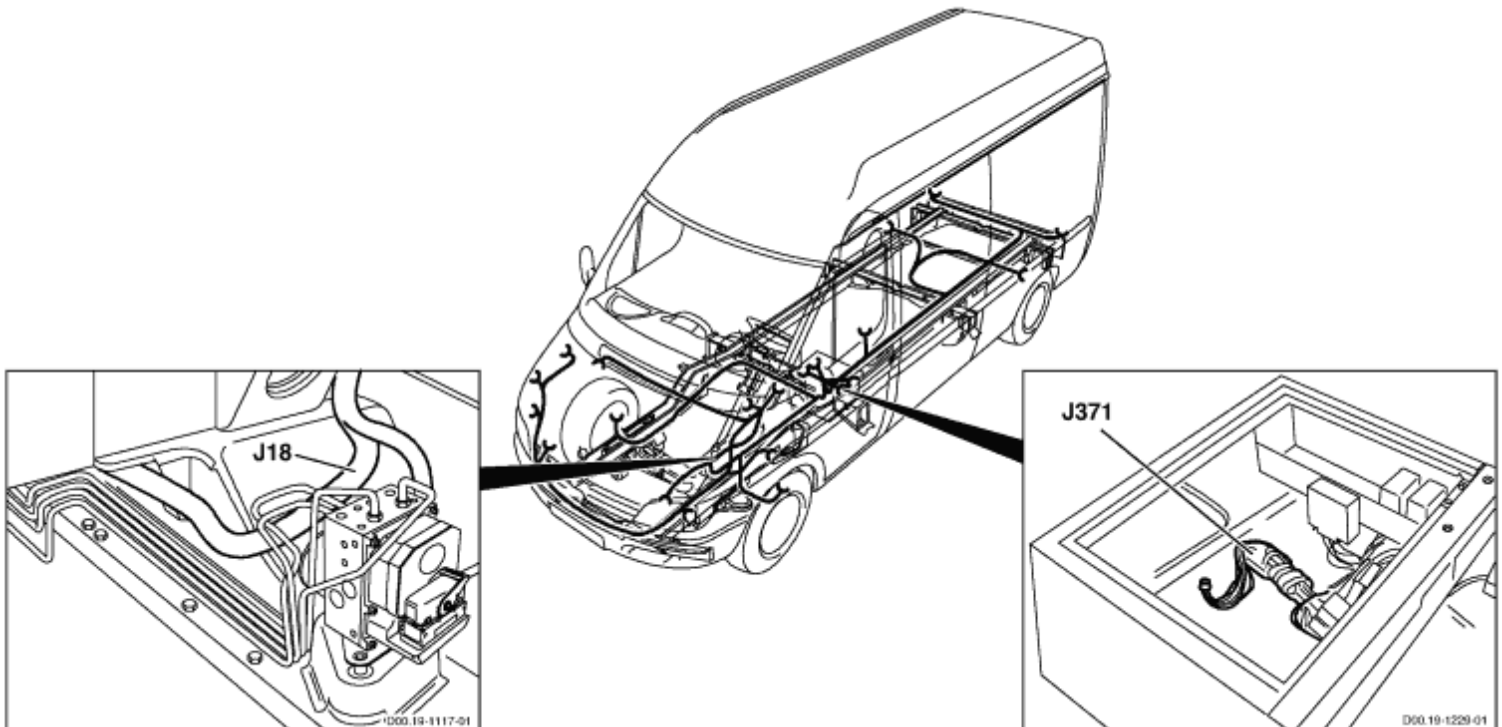

Terminal block	Designation		Component	Designation	Connector Pin
J18	FWH/engine compartment (behind battery)	→	A10	Airbag control unit	1.5
	Circuit 15 fused connector sleeve	→	A12	Electrical center	4.3
		→	A80	CDI control unit	2.13
		→	K79	Circuit 15 body manufacturer relay	4
		→	P15	Instrument cluster	2.10
J371	FWH/seat frame (behind rubber grommet)	→	A8	Central locking control unit	1.11
	Airbag crash signal connector sleeve	→	A10	Airbag control unit	1.20
		→	A80	CDI control unit	2.17

PE54.00-D-1100D	Overview of wiring diagrams for electrical system, equipment and instruments	6.3.01
------------------------	---	---------------

MODELSXD1, XD2, XD3, XD4, XD5, XD6, XD7, YD1, YD2, YD3, YD4, YD5, YD6, YD7, WD1, WD2, WD3, WD6, WD7

MODELS903.61 /66 /67, 904.61 /66 with CODE (ZU7) National version for Canada

MODELS903.61 /66 /67, 904.61 /66 with CODE (ZU8) National version for USA

MODELS903.61 /62 /66 /67, 904.61 /62 /66 with CODE (ZU9) National version for Mexico

PE54.22-D-2000E	Wiring diagram for data link connector/diagnostic socket	<p>MODEL XD1, XD2, XD3, XD4, XD5, XD6, XD7, YD1, YD2, YD3, YD4, YD5, YD6, YD7, WD1, WD2, WD3, WD6, WD7</p> <p>MODEL 903.61 /66 /67, 904.61 /66</p> <p>with CODE (ZU7) National version Canada</p> <p>MODEL 903.61 /66 /67, 904.61 /66</p> <p>with CODE (ZU8) National version USA</p> <p>MODEL 903.61 /62 /66 /67, 904.61 /62 /66</p> <p>with CODE (ZU9) National version Mexico</p>	PE54.22-D-2000E
PE54.25-D-2200C	Wiring diagram combination switch at electrical center, interior circuit	<p>MODEL XD1, XD2, XD3, XD4, XD5, XD6, XD7, YD1, YD2, YD3, YD4, YD5, YD6, YD7, WD1, WD2, WD3, WD6, WD7</p> <p>MODEL 903.61 /66 /67, 904.61 /66</p> <p>with CODE (ZU7) National version Canada</p> <p>MODEL 903.61 /66 /67, 904.61 /66</p> <p>with CODE (ZU8) National version USA</p> <p>MODEL 903.61 /62 /66 /67, 904.61 /62 /66</p> <p>with CODE (ZU9) National version for Mexico</p>	PE54.25-D-2200C
PE54.30-D-2001G	Wiring diagram large instrument (instrument cluster)	<p>MODEL XD1, XD2, XD3, XD4, XD5, XD6, XD7, YD1, YD2, YD3, YD4, YD5, YD6, YD7, WD1,</p>	PE54.30-D-2001G

		<p>WD2, WD3, WD6, WD7 MODELS 903.61 /66 /67, 904.61 /66 with CODE (J65) Outside temperature indicator with CODE (ZU7) National version for Canada MODELS 903.61 /66 /67, 904.61 /66 with CODE (J65) Outside temperature indicator with CODE (ZU8) National version for USA MODEL 903.61 /62 /66 /67, 904.61 /62 /66 with CODE (J65) Outside temperature indicator with CODE (ZU9) National version for Mexiko</p>	
<p>PE54.35-D-2000D</p>	<p>Wiring diagram signal system</p>	<p>MODEL XD1, XD2, XD3, XD4, XD5, XD6, XD7, YD1, YD2, YD3, YD4, YD5, YD6, YD7, WD1, WD2, WD3, WD6, WD7 MODEL 903.61 /66 /67, 904.61 /66 with CODE (ZU7) National version Canada MODEL 903.61 /66 /67, 904.61 /66 with CODE (ZU8) National version USA MODEL 903.61 /62 /66 /67, 904.61 /62 /66 with CODE (ZU9) National version Mexico</p>	<p>PE54.35-D-2000D</p>

PE31.19-D-2000-99G

[Display in a separate window](#)

To display wiring diagrams, you need a
JAVA 1.1 capable Browser like e.g. "Microsoft Internet Explorer 4.0"
or
"Netscape Navigator 4.05" and higher with AWT 1.1 support

- A93 Trailer socket control module
- F153 Trailer socket fuse (25 A)
- J4 Circuit 58R connector sleeve
- J8 Stop lamp connector sleeve
- J16 Circuit 30 connector sleeve
- J20 Reversing lamp connector sleeve
- J80 Right turn signal lamp connector sleeve
- J81 Left turn signal lamp connector sleeve
- J451 Trailer socket connector sleeve
- W5 Ground point seat frame
- W6 Ground point taillamp
- X232 Trailer socket plug connection

PE31.19-D-2000-60G	Legend for wiring diagram of trailer coupling	<p>MODEL XD1##, XD2##, XD3##, XD4##, XD5##, XD6##, XD7##, YD1##, YD2##, YD3##, YD4##, YD5##, YD6##, YD7##, WD1##, WD2##, WD3##, WD6##, WD7## ### up to 649051 up to 31.3.04</p> <p>MODEL 903.61# /66# /67#, 904.61# /66# ## up to 649051 up to 31.3.04 with CODE (E58) electrical system for trailer socket with CODE (ZU7) national version for Canada</p> <p>MODEL 903.61# /66# /67#, 904.61# /66# ## up to 649051 up to 31.3.04 with CODE (E58) electrical system for trailer socket with CODE (ZU8) national version for USA</p> <p>MODEL 903.61# /62# /66# /67#, 904.61# /62# /66# ## up to 649051 up to 31.3.04 with CODE (E58) electrical system for trailer socket with CODE (ZU9) national version for Mexico</p>	
--------------------	---	--	--

Code	Designation	Coordinate
A93	Trailer socket control unit	4A
F153	Trailer socket fuse (25 A)	5G
J4	Circuit R connector sleeve 58R	4G
J8	Stop light connector sleeve	4E
J16	Tml. 30 connector sleeve	6L
J20	Backup lamp connector sleeve	3G
J80	Right turn signal light connector sleeve	5E
J81	Left turn signal light connector sleeve	7E
J451	Trailer socket connector sleeve	4E
W5	Seat frame ground point	6E
W6	Ground point taillamp	3G
X232	Trailer socket connector	3L

GF00.19-D-3100-19C

Arrangement and assignment of terminal block connectors trailer coupling

Models XD1, XD2, XD3, XD4, XD5, XD6, XD7, YD1, YD2, YD3, YD4, YD5, YD6, YD7, WD1, WD2, WD3, WD6, WD7
Models 903.61/66/67, 904.61/66
with code (E58) electrical system for trailer socket
with code (ZU7) National version for Canada
Models 903.61/66/67, 904.61/66
with code (E58) electrical system for trailer socket
with code (ZU8) National version for USA
Models 903.61/62/66/67, 904.61/62/66
with code (E58) electrical system for trailer socket
with code (ZU9) National version for Mexico

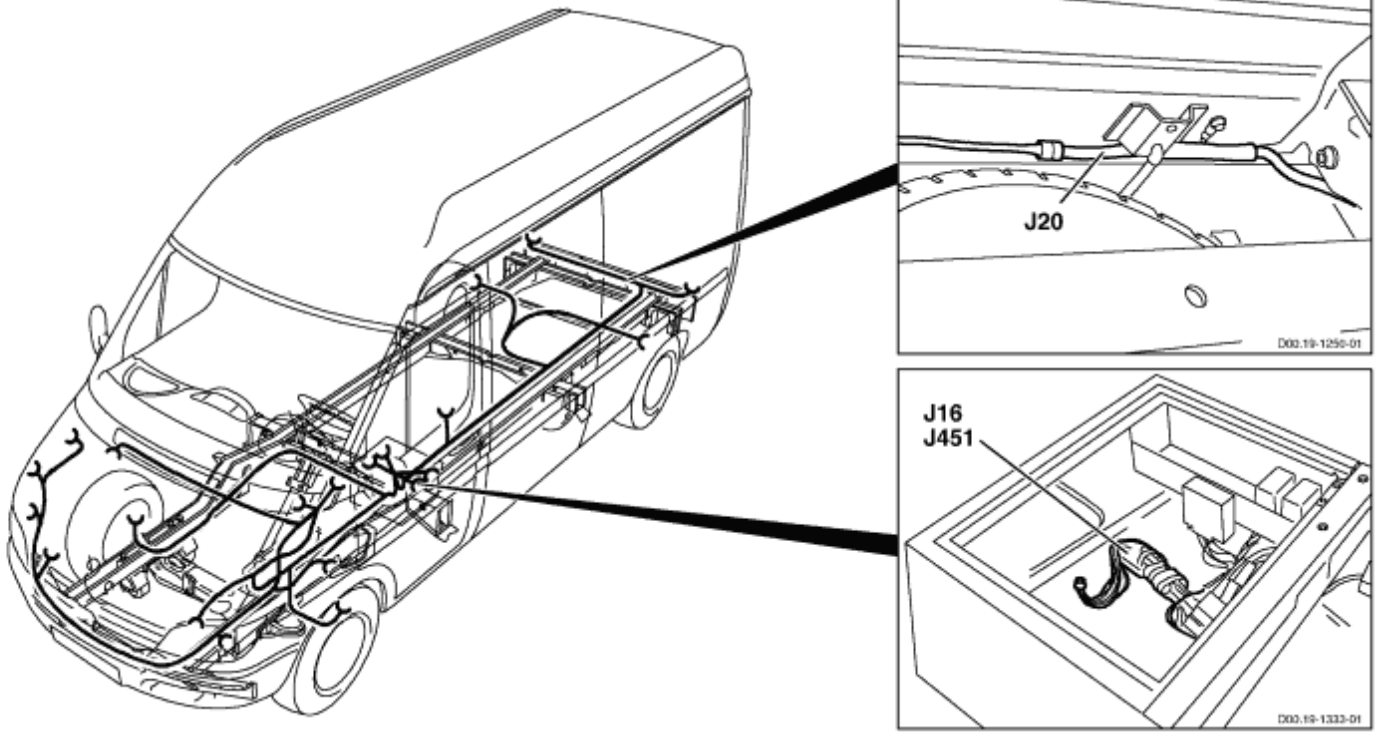

D00.19-1357-09

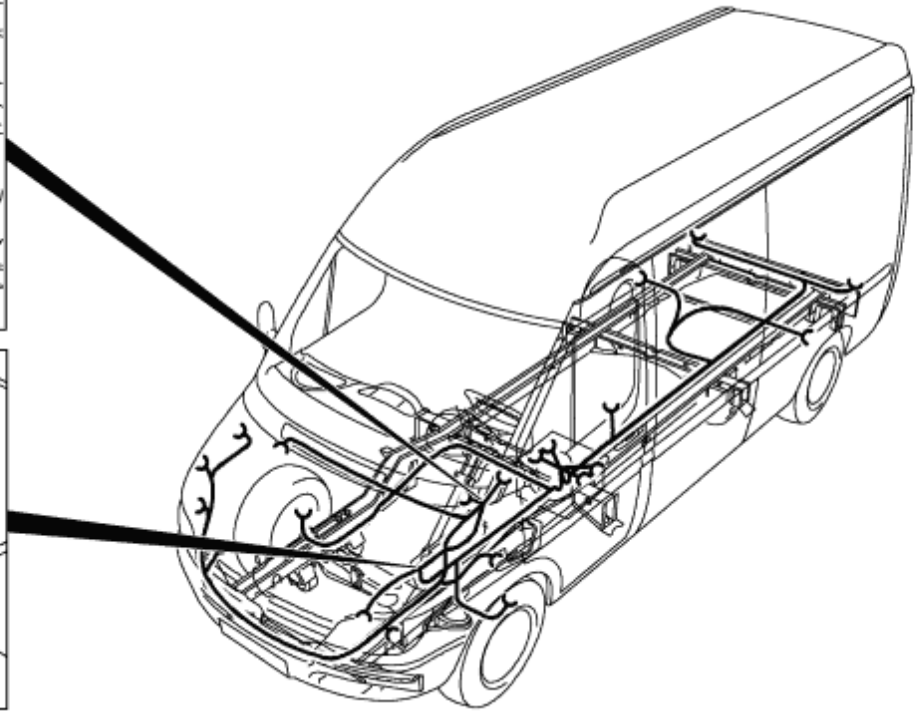
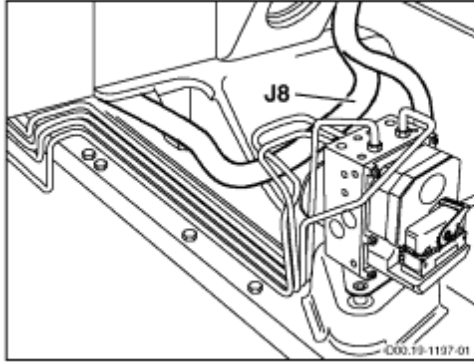
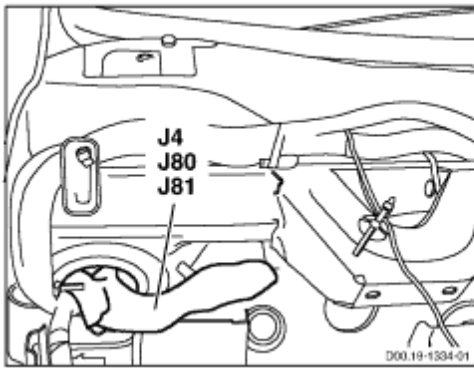

D00.19-1358-09

Terminal block	Designation		Component	Designation	Connector Pin
J4	FWH/waistrail (next to firewall rubber grommet)	→	A12	Electrical center	5.6
	Connector sleeve, terminal 58R	→	E26e6	Right side light	10
		→	E68E7	Right tail light	2
		→	K136	Daytime running lamps terminal 58R relay	1
J8	FWH/engine compartment (behind battery)	→	A2	ABS/ESP control unit	1.32
	Stop light connector sleeve	→	A93	Trailer socket control unit	2.A
		→	B127	Stop light switch 6-pin	2.2
		→	J15	Stop light connector sleeve	
		→	X45	Frame/roof connector (standard)	2
J16	FWH/seat frame (behind rubber grommet)	→	F6	ABS circuit 30 fuse	1
	Circuit 30 connector sleeve	→	F7	ABS circuit 30 fuse	1
		→	F9	Additional heater fuse (25 A)	1
		→	F11	Instrument cluster fuse (7.5 A)	1

		→	F40	Daytime running lamps fuse	1
		→	F43	Radio remote control fuse (10 A)	1
		→	F44	Central locking fuse (25 A)	1
		→	F62	Interior light fuse (15 A)	1
		→	F63	Heated rear window fuse (30 A)	1
		→	F98	Warm water heater stage 1 blower fuse (10 A)	1
		→	F101	Warm air additional heater fuse (7.5 A)	1
		→	F114	Additional heat exchanger fuse (25 A)	1
		→	F119	Air conditioning additional fan fuse (30 A)	1
		→	F138	Circuit 15 fuse (10 A)	1
		→	F140.3	Circuit 30 fuse (125 A)	2
		→	F143	Additional heater fuse (25 A)	1
		→	F148	Daytime running lamps relay fuse (10 A)	1
		→	F149	Roof AC fuse (40 A)	1
		→	F151	Fog lamp fuse (7.5 A)	1
		→	F153	Trailer socket fuse (25 A)	1
		→	F154	Instrument panel socket fuse (15 A)	1
		→	J327	Circuit 30 unfused connector sleeve	
		→	K26	Circuit D+ relay	1
J20	FWH (close to ground point W6)	→	E67e19	Left backup lamp	4
	Reversing lamp connector sleeve	→	E68E1	Right backup lamp	4
		→	X217	Frame/waistrail connector	1
		→	X232	Trailer socket connector	3
J80	FWH/waistrail (next to firewall rubber grommet)	→	A12	Electrical center	5.5
	Right turn signal light connector sleeve	→	A82	EDW control unit	1.4
		→	A93	Trailer socket control unit	2.B
		→	E26H3	Right front turn signal lamp	6
		→	E68h4	Right rear turn signal lamp	5
		→	H2	Right front side turn signal lamp (5	1

				W)	
		→	H9	Right front side turn signal lamp (21 W)	1
		→	K102	Right EDW turn signal lamp relay	1
		→	P15	Instrument cluster	1.7
J81	FWH/waistrail (next to firewall rubber grommet)	→	A12	Electrical center	5.8
	Left turn signal light connector sleeve	→	A62	WSP control unit	8
		→	A82	EDW control unit	1.1
		→	A93	Trailer socket control unit	2.E
		→	E25h21	Left front turn signal lamp	6
		→	E67h22	Left rear turn signal lamp	5
		→	H5	Left front side turn signal lamp (5 W)	1
		→	H10	Left front side turn signal lamp (21 W)	1
		→	K101	Left EDW turn signal lamp relay	1
		→	P15	Instrument cluster	2.13
J451	FWH/seat frame (behind rubber grommet)	→	A93	Trailer socket control unit	2.D
	Trailer socket connector sleeve	→	F153	Trailer socket fuse (25 A)	2
		→	X232	Trailer socket connector	4

PE31.19-D-2000-99H

[Display in a separate window](#)

To display wiring diagrams, you need a
JAVA 1.1 capable Browser like e.g. "Microsoft Internet Explorer 4.0"
or
"Netscape Navigator 4.05" and higher with AWT 1.1 support

- A93 Trailer socket control module
- F153 Trailer socket fuse (25 A)
- J4 Circuit 58R connector sleeve
- J8 Stop lamp connector sleeve
- J16 Circuit 30 connector sleeve
- J20 Reversing lamp connector sleeve
- J80 Right turn signal lamp connector sleeve
- J81 Left turn signal lamp connector sleeve
- J451 Trailer socket connector sleeve
- W5 Ground point seat frame
- W6 Ground point taillamp
- X232 Trailer socket plug connection

PE31.19-D-2000-60H	Legend for wiring diagram of trailer coupling	<p>MODEL XD1##, XD2##, XD3##, XD4##, XD5##, XD6##, XD7##, YD1##, YD2##, YD3##, YD4##, YD5##, YD6##, YD7##, WD1##, WD2##, WD3##, WD6##, WD7## ### as of 649052 as of 1.4.04</p> <p>MODEL 903.61# /66# /67#, 904.61# /66# ## as of 649052 as of 1.4.04 with CODE (E58) electrical system for trailer socket with CODE (ZU7) national version for Canada</p> <p>MODEL 903.61# /66# /67#, 904.61# /66# ## as of 649052 as of 1.4.04 with CODE (E58) electrical system for trailer socket with CODE (ZU8) national version for USA</p> <p>MODEL 903.61# /62# /66# /67#, 904.61# /62# /66# ## as of 649052 as of 1.4.04 with CODE (E58) electrical system for trailer socket with CODE (ZU9) national version for Mexico</p>	
--------------------	---	--	--

Code	Designation	Coordinate
A93	Trailer socket control unit	4A
F153	Trailer socket fuse (25 A)	5G
J4	Circuit R connector sleeve 58R	4G
J8	Stop light connector sleeve	4E
J16	Tml. 30 connector sleeve	6L
J20	Backup lamp connector sleeve	3G
J80	Right turn signal light connector sleeve	5E
J81	Left turn signal light connector sleeve	6E
J451	Circuit 30 connector sleeve, fused (trailer socket)	4E
W5	Seat frame ground point	3E
W6	Ground point taillamp	3G
X232	Trailer socket connector	3L

PE42.30-D-2200-99B

[Display in a separate window](#)

To display wiring diagrams, you need a
JAVA 1.1 capable Browser like e.g. "Microsoft Internet Explorer 4.0"
or
"Netscape Navigator 4.05" and higher with AWT 1.1 support

A2	ABS control module
A2	ABS control module
A2	ABS control module
A12	Electrical center
A40	Electronic selector lever module control module
B79	Left front wheel speed sensor
B80	Right front wheel speed sensor
B81	Left rear wheel speed sensor
B82	Right rear wheel speed sensor
B127	Stop lamp switch, 6- pin
F5	ABS fuse
F6	ABS fuse, terminal 30
F7	ABS fuse, terminal 30
J8	Stop lamp connector sleeve
J16	Circuit 30 connector sleeve
J31	Terminal 15 connector sleeve, fused
J46	Terminal 58 connector sleeve
J105	Terminal 15 connector sleeve
J132	Right rear wheel speed sensor connector sleeve
J134	Left rear wheel speed sensor ground connector sleeve
J135	Left rear wheel speed sensor connector sleeve
J136	Right rear wheel speed sensor ground connector

sleeve
J277 Terminal 15
connector sleeve
J332 Terminal 15
connector sleeve,
fused
J340 CAN High connector
sleeve
J378 CAN Low connector
sleeve
J401 Diagnostic line
connector sleeve
P17 Diagnostic socket
16-pin
S48 ASR switch
W7 Ground point
(engine
compartment)
W8 Ground point
(waistrail)
W27 Ground point (ABS)
X79 Frame/waistrail
connector
X217 Frame/dash support
connector

PE42.30-D-2200-60B	Legend of wiring diagram anti-lock brake system (ABS)/ acceleration slip regulation (ASR)	<p>MODELS XD1, XD2, XD3, XD6, XD7, YD1, YD2, YD3, YD6, YD7, WD1, WD2, WD3, WD6, WD7</p> <p>MODELS 903.6166 67 with CODE (BB0) Brake system anti-lock brake system ABS with CODE (ZU7) National version for Canada</p> <p>MODEL 903.6166 67 with CODE (BB0) Brake system anti-lock brake system ABS with CODE (ZU8) National version for USA</p> <p>MODELS 903.61 /62 /66 /67 with CODE (BB0) Brake system, antilock brake system, ABS with CODE (ZU9) National version for Mexiko</p>	
--------------------	---	---	--

Code	Designation	Coordinate
A2	ABS/ESP control unit	4A 12A 20A
A12	Electrical center	9L
A40	EWM control unit	3L
B79	Left front wheel speed sensor	14L
B80	Right front wheel speed sensor	16L
B81	Left rear wheel speed sensor	17L
B82	Right rear wheel speed sensor	19L
B127	Stop light switch 6-pin	6L
F5	ABS fuse	1G
F6	ABS fuse, circuit 30	2G
F7	ABS fuse, circuit 30	3G
J8	Stop light connector sleeve	7G
J16	Circuit 30 connector sleeve	2L
J31	Circuit 15 fused connector sleeve	1L
J46	Circuit 58 connector sleeve	21G

J105	Circuit 15 connector sleeve	21G
J132	Rear right wheel speed sensor connector sleeve	18G
J134	Left rear wheel speed sensor ground connector sleeve	17G
J135	Left rear wheel speed sensor connector sleeve	17G
J136	Right rear wheel speed sensor ground connector sleeve	19G
J277	Circuit 15 connector sleeve	6G
J332	Circuit 15 fused connector sleeve	1E
J340	CAN-high connector sleeve	12G
J378	CAN-low connector sleeve	12G
J401	Diagnostic cable connector sleeve	10E
P17	Diagnostic socket 16-pin	11H
S48	ASR switch	21L
W7	Engine compartment ground point	6E
W8	Ground point waistrail	22G
W27	Ground point ABS	5E
X79	Frame/waistrail connector	20E
X217	Frame/waistrail connector	4H

GF00.19-D-3100-61B

Arrangement and assignment of terminal block connectors anti-lock brake system (ABS)/acceleration slip regulation (ASR)

Models XD1, XD2, XD3, XD4, XD5, XD6, XD7, YD1, YD2, YD3, YD4, YD5, YD6, YD7, WD1, WD2, WD3, WD6, WD7
Models 903.61/66/67, 904.61/66
with code (ZU7) National version for Canada
Models 903.61/66/67, 904.61/66
with code (ZU8) National version for USA
Models 903.61/62/66/67, 904.61/62/66
with code (ZU9) National version for Mexico

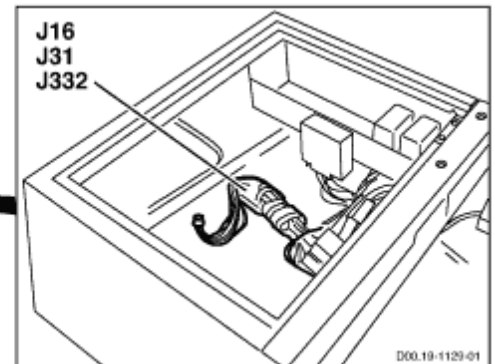
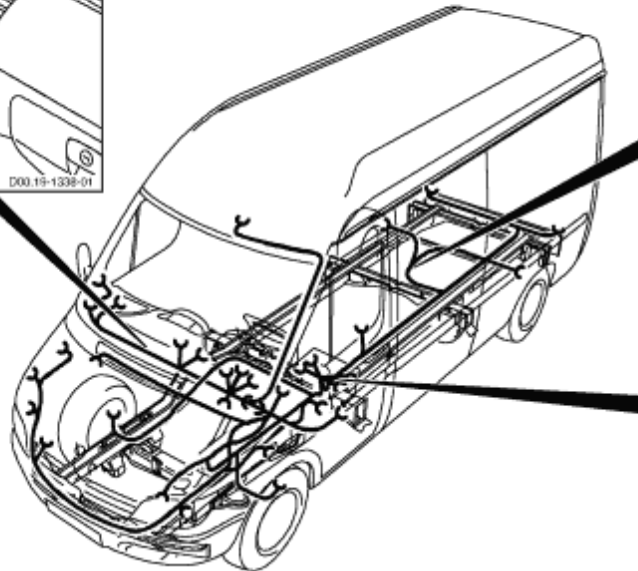
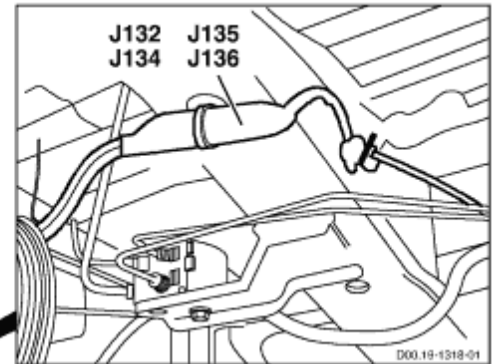
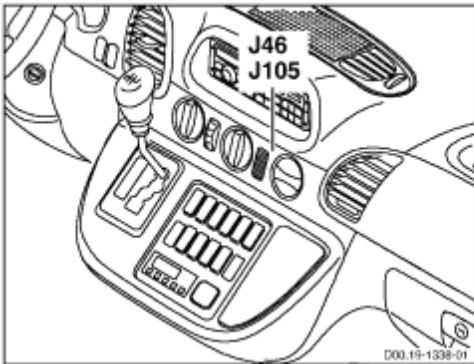

D00.19-1360-09

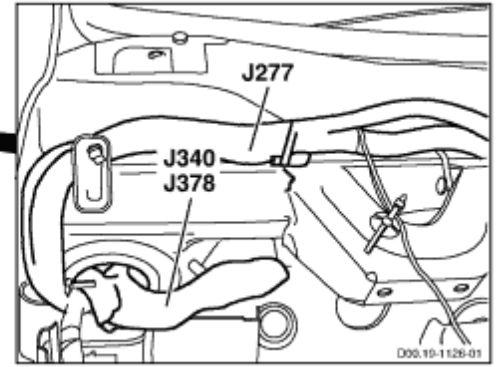
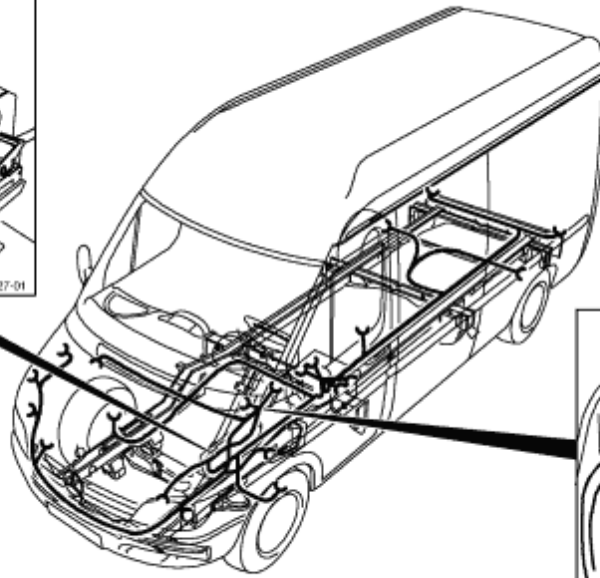
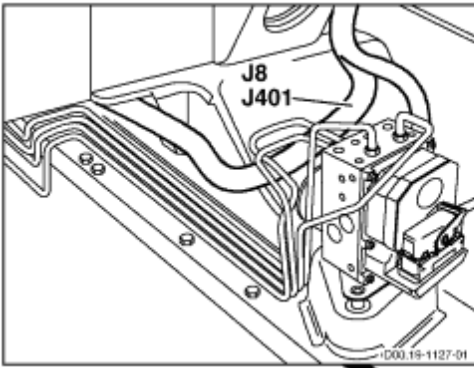

D00.19-1153-09

Terminal block	Designation		Component	Designation	Connector Pin
J8	FWH/engine compartment (behind battery)	→	A2	ABS/ESP control unit	1.32
	Stop light connector sleeve	→	A93	Trailer socket control unit	2.A
		→	B127	Stop light switch 6-pin	2.2
		→	J15	Stop light connector sleeve	
		→	X45	Frame/roof connector (standard)	2
J16	FWH/seat frame (behind rubber grommet)	→	F6	ABS circuit 30 fuse	1
	Circuit 30 connector sleeve	→	F7	ABS circuit 30 fuse	1
		→	F9	Additional heater fuse (25 A)	1
		→	F11	Instrument cluster fuse (7.5 A)	1
		→	F40	Daytime running lamps fuse	1
		→	F43	Radio remote control fuse (10 A)	1
		→	F44	Central locking fuse (25 A)	1
		→	F62	Interior light fuse (15 A)	1
		→	F63	Heated rear window fuse (30 A)	1
		→	F98	Warm water heater stage 1 blower	1

				fuse (10 A)	
		→	F101	Warm air additional heater fuse (7.5 A)	1
		→	F114	Additional heat exchanger fuse (25 A)	1
		→	F119	Air conditioning additional fan fuse (30 A)	1
		→	F138	Circuit 15 fuse (10 A)	1
		→	F140.3	Circuit 30 fuse (125 A)	2
		→	F143	Additional heater fuse (25 A)	1
		→	F148	Daytime running lamps relay fuse (10 A)	1
		→	F149	Roof AC fuse (40 A)	1
		→	F151	Fog lamp fuse (7.5 A)	1
		→	F153	Trailer socket fuse (25 A)	1
		→	F154	Instrument panel socket fuse (15 A)	1
		→	J327	Circuit 30 unfused connector sleeve	
		→	K26	Circuit D+ relay	1
J31	FWH/seat frame (behind rubber grommet)	→	F5	ABS terminal 15 fuse	1
	Circuit 15 fused connector sleeve	→	F52	Front passenger door power window fuse (25 A)	1
		→	F53	Driver door power window fuse (25 A)	1
		→	F54	Heated and adjustable exterior mirror fuse (10 A)	1
		→	F86	EDW circuit 15 fuse (7.5 A)	1
		→	F127	Differential lock fuse (15 A)	1
		→	F128	Driver, passenger seat heater fuse (15 A)	1
		→	F139	Additional heater fuse (10 A)	1
		→	F150	Roof fan fuse (15 A)	1
		→	K70	Circuit 15 relay for optional equipment	1
J46	WWH (middle of instrument panel)	→	A9	Radio	1.A6
	Circuit 58 connector sleeve	→	A40	EWM control unit	2
		→	A71	Heater timer	1

		→	A81	Air conditioning pushbutton control and operating unit	1.9
		→	E104	Ashtray lighting	1
		→	S12	Driver seat heater switch	1
		→	S25	Headlamp range adjustment switch	9
		→	S48	ASR switch	1
		→	S57	Differential lock switch	1
		→	S81	Rear window defroster pushbutton	1
		→	S85	Driver interior lighting pushbutton	1
		→	S87	Auxiliary heater switch	1
		→	S90	Roof fan switch	1
		→	S92	Panic alarm button	1
		→	S99	ATA [EDW] towing/interior motion sensor button	1
		→	S100	Additional heat exchanger double-contact pushbutton	1
		→	S107	Front passenger seat heater switch	1
		→	S119.1	Fog light switch	1
		→	S124	Reading lamp switch	1
		→	S126	Interior pushbutton	1
		→	S137	Roof AC switch	1
		→	S138	Temperature switch	9
		→	X79	Frame/waistrail connector	2
		→	X234	Cigar lighter illumination plug connection	3
J105	WWH (middle of instrument panel)	→	A71	Heater timer	10
	Circuit 15 connector sleeve	→	A81	Air conditioning pushbutton control and operating unit	1.21
		→	S48	ASR switch	7
		→	S100	Additional heat exchanger double-contact pushbutton	3 8
		→	X79	Frame/waistrail connector	1
J132	FWH (cross member rear spring bracket at front; cast)	→	A2	ABS/ESP control unit	1.31
	Rear right wheel speed sensor connector sleeve	→	B82	Right rear wheel speed sensor	

J134	FWH (cross member rear spring bracket at front; cast)	→	A2	ABS/ESP control unit	1.29
	Left rear wheel speed sensor ground connector sleeve	→	B81	Left rear wheel speed sensor	
J135	FWH (cross member rear spring bracket at front; cast)	→	A2	ABS/ESP control unit	1.14
	Left rear wheel speed sensor connector sleeve	→	B81	Left rear wheel speed sensor	
J136	FWH (cross member rear spring bracket at front; cast)	→	A2	ABS/ESP control unit	1.30
	Right rear wheel speed sensor ground connector sleeve	→	B82	Right rear wheel speed sensor	
J277	FWH/waistrail (behind instrument cluster)	→	A12	Electrical center	5.1
	Circuit 15 connector sleeve	→	B127	Stop light switch 6-pin	1.2 2.1
		→	P17	Diagnostic socket 16-pin	8
J332	FWH/seat frame (behind rubber grommet)	→	A2	ABS/ESP control unit	1.23
	Circuit 15 fused connector sleeve	→	F5	ABS terminal 15 fuse	2
J340	FWH/waistrail (next to firewall rubber grommet)	→	A2	ABS/ESP control unit	1.24
	CAN-high connector sleeve	→	A62	WSP control unit	5
		→	J422	CAN-high connector sleeve	
		→	P15	Instrument cluster	1.18
		→	X82	Frame/waistrail connector	3
		→	X217	Frame/waistrail connector	7
J378	FWH/waistrail (next to firewall rubber grommet)	→	A2	ABS/ESP control unit	1.40
	CAN-low connector sleeve	→	A62	WSP control unit	6
		→	J421	CAN-low connector sleeve	
		→	P15	Instrument cluster	1.17
		→	X82	Frame/waistrail connector	4
		→	X217	Frame/waistrail connector	8
J401	FWH/engine compartment (behind battery)	→	A2	ABS/ESP control unit	11
	Diagnostic cable connector sleeve	→	P17	Diagnostic socket 16-pin	9
		→	X217	Frame/waistrail connector	4

MODELSXD1, XD2, XD3, XD4, XD5, XD6, XD7, YD1, YD2, YD3, YD4, YD5, YD6, YD7, WD1, WD2, WD3, WD6, WD7

MODELS903.61 /66 /67, 904.61 /66 with CODE (ZU7) National version for Canada

MODELS903.61 /66 /67, 904.61 /66 with CODE (ZU8) National version for USA

MODELS903.61 /62 /66 /67, 904.61 /62 /66 with CODE (ZU9) National version for Mexico

<p>PE00.19-D-2200D</p>	<p>Wiring diagram CAN bus engine</p>	<p>Models XD1##, XD2##, XD3##, XD4##, XD5##, XD6##, XD7##, YD1##, YD2##, YD3##, YD4##, YD5##, YD6##, YD7##, WD1##, WD2##, WD3##, WD6##, WD7## ### up to 529900 up to 4/30/03 Models 903.61#/66#/67#, 904.61#/66# ## up to 529900 up to 4/30/03 with CODE (ZU7) National version for Canada Models 903.61#/66#/67#, 904.61#/66# ## up to 529900 up to 4/30/03 with CODE (ZU8) National version for USA Models 903.61#/62#/66#/67#, 904.61#/62#/66# ## up to 529900 up to 4/30/03 with code (ZU9) National version for Mexico</p>	<p>PE00.19-D-2200D</p>
<p>PE00.19-D-2200E</p>	<p>Wiring diagram CAN bus engine</p>	<p>Models XD1##, XD2##, XD3##, XD4##, XD5##, XD6##, XD7##, YD1##, YD2##, YD3##, YD4##, YD5##, YD6##, YD7##, WD1##, WD2##, WD3##, WD6##, WD7## ### as of 529901 as of 5/5/03 Models 903.61#/66#/67#, 904.61#/66# ## as of 529901 as of 5/5/03 with code (ZU7) National version for Canada Models 903.61#/66#/67#, 904.61#/66# ## as of 529901 as</p>	<p>PE00.19-D-2200E</p>

		<p>of 5/5/03 with code (ZU8) National version for USA Models 903.61#/62#/66#/67#, 904.61#/62#/66# ## as of 529901 as of 5/5/03 with code (ZU9) National version for Mexico</p>	
--	--	--	--

PE42.30-D-2200-99C

[Display in a separate window](#)

To display wiring diagrams, you need a
JAVA 1.1 capable Browser like e.g. "Microsoft Internet Explorer 4.0"
or
"Netscape Navigator 4.05" and higher with AWT 1.1 support

A2	ABS control module
A2	ABS control module
A2	ABS control module
A12	Electrical center
A40	Electronic selector lever module control module
B79	Left front wheel speed sensor
B80	Right front wheel speed sensor
B81	Left rear wheel speed sensor
B82	Right rear wheel speed sensor
B127	Stop lamp switch, 6- pin
F5	ABS fuse
F6	ABS fuse, terminal 30
F7	ABS fuse, terminal 30
J8	Stop lamp connector sleeve
J16	Circuit 30 connector sleeve
J31	Terminal 15 connector sleeve, fused
J46	Terminal 58 connector sleeve
J105	Terminal 15 connector sleeve
J132	Right rear wheel speed sensor connector sleeve
J134	Left rear wheel speed sensor ground connector sleeve
J135	Left rear wheel speed sensor connector sleeve
J136	Right rear wheel speed sensor ground connector

sleeve
J277 Terminal 15
connector sleeve
J332 Terminal 15
connector sleeve,
fused
J340 CAN High connector
sleeve
J378 CAN Low connector
sleeve
J401 Diagnostic line
connector sleeve
P17 Diagnostic socket
16-pin
S48 ASR switch
W7 Ground point
(engine
compartment)
W8 Ground point
(waistrail)
W27 Ground point (ABS)
X79 Frame/waistrail
connector
X217 Frame/dash support
connector

PE42.30-D-2200-60C	Legend of wiring diagram anti-lock brake system (ABS)/ acceleration slip regulation (ASR)	<p>MODELS XD4, XD5, YD4, YD5</p> <p>MODEL with CODE (BB0) Brake system anti-lock brake system ABS</p> <p>with CODE (ZU7) National version for Canada</p> <p>MODEL with CODE (BB0) Brake system, anti-lock brake system, ABS</p> <p>with CODE (ZU8) National version for USA</p> <p>MODEL 904.61 /62 /66 with CODE (BB0) Brake system, antilock brake system, ABS</p> <p>with CODE (ZU9) National version for Mexiko</p>	
--------------------	---	---	--

Code	Designation	Coordinate
A2	ABS/ESP control unit	4A 12A 20A
A12	Electrical center	9L
A40	EWM control unit	3L
B79	Left front wheel speed sensor	14L
B80	Right front wheel speed sensor	16L
B81	Left rear wheel speed sensor	17L
B82	Right rear wheel speed sensor	19L
B127	Stop light switch 6-pin	6L
F5	ABS fuse	1G
F6	ABS fuse, circuit 30	2G
F7	ABS fuse, circuit 30	3G
J8	Stop light connector sleeve	7G
J16	Circuit 30 connector sleeve	2L
J31	Circuit 15 fused connector sleeve	1L
J46	Circuit 58 connector sleeve	21G
J105	Circuit 15 connector sleeve	21G
J132	Rear right wheel speed sensor connector sleeve	18G

J134	Left rear wheel speed sensor ground connector sleeve	17G
J135	Left rear wheel speed sensor connector sleeve	17G
J136	Right rear wheel speed sensor ground connector sleeve	19G
J277	Circuit 15 connector sleeve	6G
J332	Circuit 15 fused connector sleeve	1E
J340	CAN-high connector sleeve	12G
J378	CAN-low connector sleeve	12G
J401	Diagnostic cable connector sleeve	10E
P17	Diagnostic socket 16-pin	11H
S48	ASR switch	21L
W7	Engine compartment ground point	6E
W8	Ground point waistrail	22G
W27	Ground point ABS	5E
X79	Frame/waistrail connector	20E
X217	Frame/waistrail connector	4H

PE27.45-D-2000-99A

[Display in a separate window](#)

To display wiring diagrams, you need a
JAVA 1.1 capable Browser like e.g. "Microsoft Internet Explorer 4.0"
or
"Netscape Navigator 4.05" and higher with AWT 1.1 support

A80 CDI control module
A94 CDI control module
J46 Terminal 58
connector sleeve
J142 Circuit 15, fused,
connector sleeve
J433 ADR switch
connector sleeve
S161 ADR ON switch
W8 Ground point
(waistrail)
X81 Frame/waistrail
connector

PE27.45-D-2000-60A	Legend of wiring diagram of working speed control (ADR)	<p>TRANSMISSION 722.681 in MODEL XD1, XD2, XD3, XD4, XD5, XD6, XD7, YD1, YD2, YD3, YD4, YD5, YD6, YD7, WD1, WD2, WD3, WD6, WD7 with CODE (G40) Automatic transmission with CODE (M54) rpm increase with constant speed control</p> <p>TRANSMISSION 722.681 in MODEL 903.61 /66 /67, 904.61 /66 with CODE (G40) Automatic transmission with CODE (M54) rpm increase with constant speed control</p> <p>with CODE (ZU7) National version for Canada</p> <p>TRANSMISSION 722.681 in MODEL 903.61 /66 /67, 904.61 /66 with CODE (G40) Automatic transmission with CODE (M54) rpm increase with constant speed control</p> <p>with CODE (ZU8) National version for Canada</p>	
--------------------	---	--	--

Code	Designation	Coordinate
A80	CDI control unit	1A
A94	CDI control unit	2A
J46	Circuit 58 connector sleeve	4G
J142	Circuit 15 fused connector sleeve	3A
J433	ADR switch connector sleeve	1G
S161	ADR ON switch	3L
W8	Ground point waistrail	2G
X81	Frame/waistrail connector	1E

PE82.10-D-2000-99E

[Display in a separate window](#)

To display wiring diagrams, you need a
JAVA 1.1 capable Browser like e.g. "Microsoft Internet Explorer 4.0"
or
"Netscape Navigator 4.05" and higher with AWT 1.1 support

A12	Electrical center
A12	Electrical center
A12	Electrical center
A12	Electrical center
A12	Electrical center
A12	Electrical center
A12f4	Backup lamp fuse
A40	Electronic selector lever module control module
E25	Left headlamp
E25	Left headlamp
E25e4	Left fog lamp
E25e9	Left side light
E25e64	Left low beam
E25e66	Left main beam
E25h21	Left turn signal light
E25m1	Left headlamp range adjustment motor
E26	Right headlamp
E26	Right headlamp
E26e5	Right fog light
E26e6	Right side light
E26e63	Right low beam
E26e65	Right main beam
E26h3	Right turn signal light
E26m1	Right headlamp range adjustment motor
E67	Left rear lamp
E67	Left rear lamp
E67e8	Left taillamp
E67e8	Left taillamp
E67e19	Left reversing light
E67e19	Left reversing light
E67e33	Left side light
E67e36	Left rear perimeter lamp

E67e81	Left chassis license plate lighting
E67h18	Left stop lamp
E67h18	Left stop lamp
E67h22	Left rear turn signal lamp
E67h22	Left rear turn signal lamp
E68	Right rear lamp
E68	Right rear lamp
E68e1	Right reversing light
E68e1	Right reversing light
E68e7	Right taillamp
E68e7	Right taillamp
E68e34	Right side light
E68e34	Right side light
E68e37	Right rear perimeter lamp
E68e82	Right chassis license plate lighting
E68h4	Right rear turn signal lamp
E68h4	Right rear turn signal lamp
E68h19	Right stop lamp
E68h19	Right stop lamp
J4	Circuit 58R connector sleeve
J4	Circuit 58R connector sleeve
J20	Reversing lamp connector sleeve
J20	Reversing lamp connector sleeve
J33	Circuit 58 connector sleeve
J38	Circuit 56 connector sleeve
J46	Terminal 58 connector sleeve
J46	Terminal 58

	connector sleeve
J79	Circuit 58L connector sleeve
J79	Circuit 58L connector sleeve
J148	Circuit 56b connector sleeve
J356	Headlamp range adjustment connector sleeve
J356	Headlamp range adjustment connector sleeve
J446	Circuit 58 connector sleeve
J446	Circuit 58 connector sleeve
P15	Instrument cluster
S25	Headlamp range adjustment switch
S53	Steering lock with mechanical repeat start lockout
W2	Ground point right headlamp
W2	Ground point right headlamp
W2	Ground point right headlamp
W6	Ground point taillamp
W6	Ground point taillamp
W7	Ground point (engine compartment)
W7	Ground point (engine compartment)
W8	Ground point (wastrail)
X79	Frame/wastrail connector
X79	Frame/wastrail connector

X217 Frame/dash
support connector

PE82.10-D-2000-60E	Legend for wiring diagram of exterior lights	<p>Model XD1, XD2, XD3, XD4, XD5, XD6, XD7, YD1, YD2, YD3, YD4, YD5, YD6, YD7, WD1, WD2, WD3, WD6, WD7</p> <p>Models 903.61 /66 /67, 904.61 /66 with CODE (ZU7) Canada national version</p> <p>Models 903.61 /66 /67, 904.61 /66 with CODE (ZU8) USA national version</p> <p>Models 903.61 /62 /66 /67, 904.61 /62 /66 with CODE (ZU9) Mexico national version</p>	
--------------------	--	--	--

Code	Designation	Coordinate
A12	Electrical center	4A 12A 20A 28A 36A 42A
A12f4	Reversing lamp fuse	42B
A40	EWM control unit	42L
E25	Left headlamp	5L 11L
E25e4	Left fog lamp	7K
E25e9	Left side light	7K
E25e64	Left low beam	9K
E25e66	Left high beam	10K
E25h21	Left turn signal lamp	8K
E25m1	Left headlamp range adjustment motor	6K
E26	Right headlamp	14L 19L
E26e5	Right fog lamp	16K
E26e6	Right side light	18K
E26e63	Right low beam	16K
E26e65	Right high beam	13K

E26h3	Right turn signal lamp	17K
E26m1	Right headlamp range adjustment motor	21K
E67	Left rear lamp	24L 32L
E67e8	Left tail light	25K 34K
E67e19	Left backup lamp	23K 32K
E67e33	Left side light	25K
E67e36	Left rear perimeter lamp	30K
E67e81	Left chassis license plate lighting	33K
E67h18	Left stop light	24K 32K
E67h22	Left rear turn signal lamp	23K 31K
E68	Right rear lamp	27L 38L
E68e1	Right backup lamp	29K 40K
E68e7	Right tail light	27K 38K
E68e34	Right side light	26K 36K
E68e37	Right rear perimeter lamp	36K
E68e82	Right chassis license plate lighting	37K
E68h4	Right rear turn signal lamp	28K 39K
E68h19	Right stop lamp	28K 39K
J4	Circuit 58R connector sleeve	18H 31E
J20	Reversing lamp connector sleeve	26E 31E
J33	Circuit 58 connector sleeve	20E
J38	Circuit 56a connector sleeve	11E
J46	Circuit 58 connector sleeve	1H 22C
J79	Circuit 58L connector sleeve	7H 27E

J148	Circuit 56b connector sleeve	9E
J356	Headlamp range adjustment connector sleeve	4H 20H
J446	Circuit 58 connector sleeve	5H 20H
P15	Instrument cluster	12L
S25	Headlamp range adjustment switch	2L
S53	Steering lock with mechanical repeat start lockout	2A
W2	Ground point right headlamp	14H 19H 21H
W6	Ground point taillamp	28E 32E
W7	Engine compartment ground point	6H 12H
W8	Ground point waistrail	1H
X79	Frame/waistrail connector	3H 22E
X217	Frame/waistrail connector	41H

GF00.19-D-3100-36C

Arrangement and assignment of terminal block connectors exterior lights

Models XD1, XD2, XD3, XD4, XD5, XD6, XD7, YD1, YD2, YD3, YD4, YD5, YD6, YD7, WD1, WD2, WD3, WD6, WD7
Models 903.61/66/67, 904.61/66
with code (ZU7) National version for Canada
Models 903.61/66/67, 904.61/66
with code (ZU8) National version for USA
Models 903.61/62/66/67, 904.61/62/66
with code (ZU9) National version for Mexico

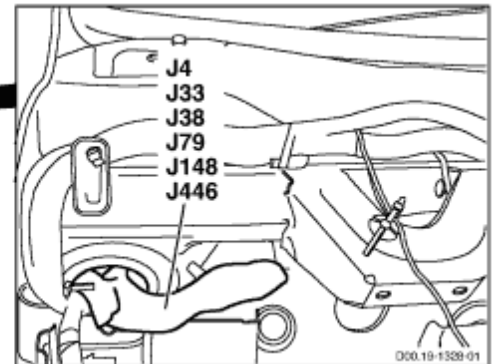
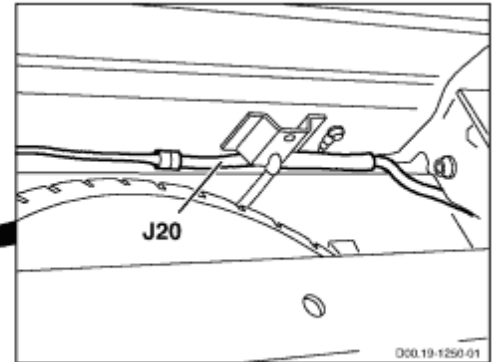
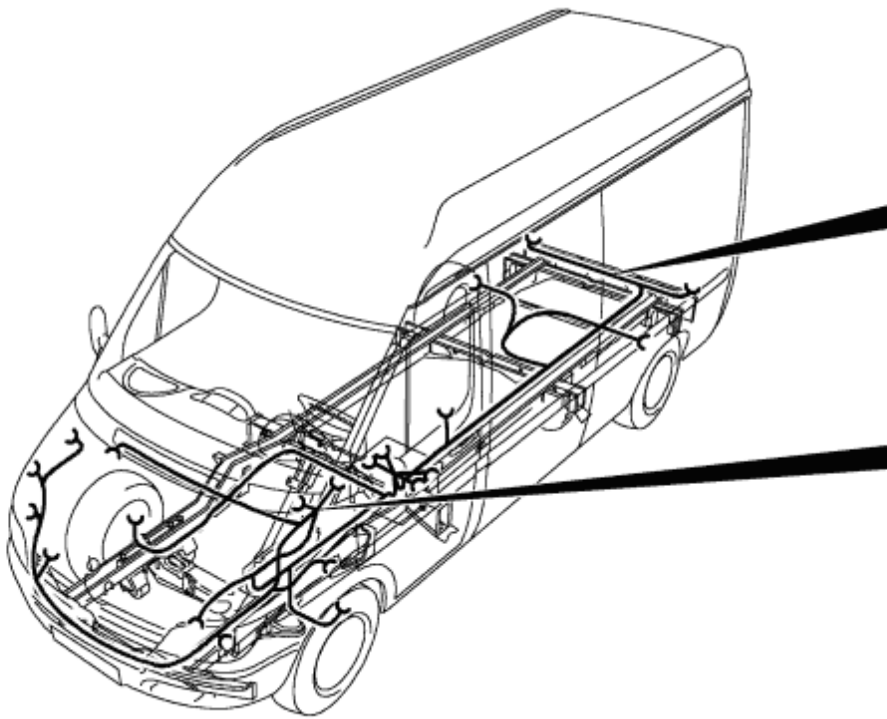

D00.19-1372-09

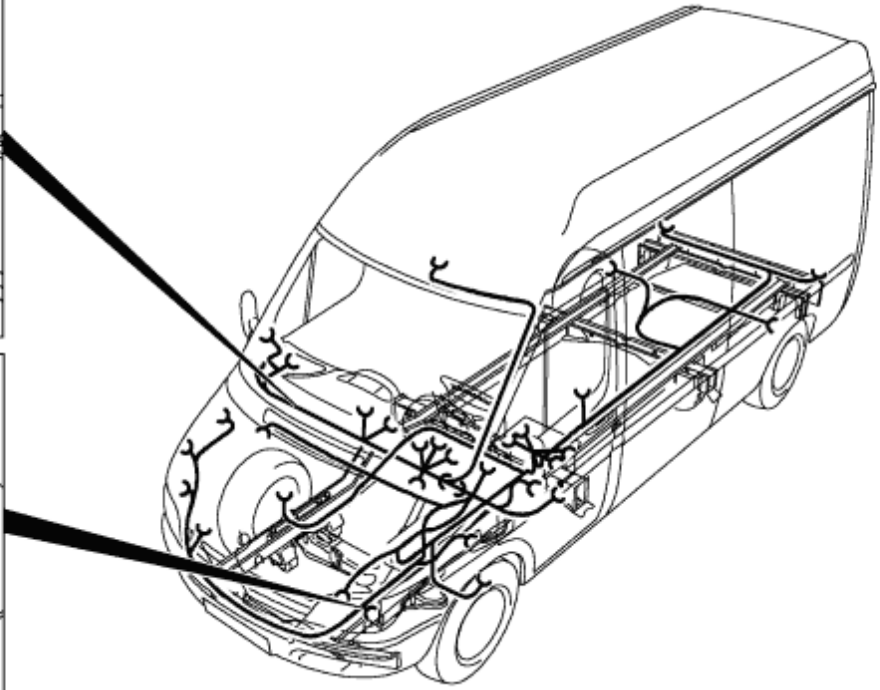
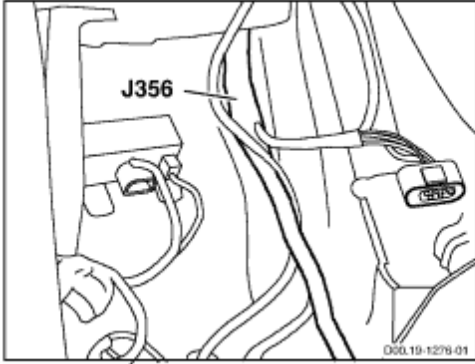
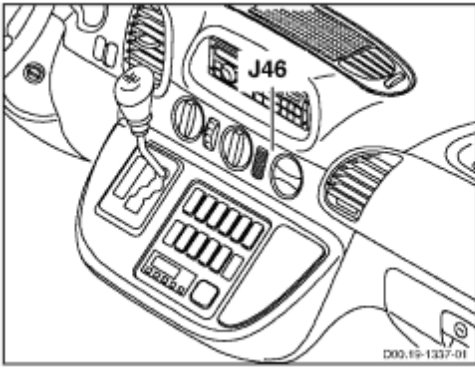

D00.19-1373-09

Terminal block	Designation		Component	Designation	Connector Pin
J4	FWH/waistrail (next to firewall rubber grommet)	→	A12	Electrical center	5.6
	Connector sleeve, terminal 58R	→	E26e6	Right side light	10
		→	E68E7	Right tail light	2
		→	K136	Daytime running lamps terminal 58R relay	1
J20	FWH (close to ground point W6)	→	E67e19	Left backup lamp	4
	Reversing lamp connector sleeve	→	E68E1	Right backup lamp	4
		→	X217	Frame/waistrail connector	1
		→	X232	Trailer socket connector	3
J33	FWH/waistrail (next to firewall rubber grommet)	→	A12	Electrical center	5.7
	Circuit 58 connector sleeve	→	J446	Circuit 58 connector sleeve	
		→	K140	Daytime running lamps circuit 58 relay	3
		→	X79	Frame/waistrail connector	2
J38	FWH/waistrail (next to firewall rubber grommet)	→	A12	Electrical center	4.5

	Circuit 56a connector sleeve	→	E25e66	Left high beam	9
		→	P15	Instrument cluster	2.8
J46	WWH (middle of instrument panel)	→	A9	Radio	1.A6
	Circuit 58 connector sleeve	→	A40	EWM control unit	2
		→	A71	Heater timer	1
		→	A81	Air conditioning pushbutton control and operating unit	1.9
		→	E104	Ashtray lighting	1
		→	S12	Driver seat heater switch	1
		→	S25	Headlamp range adjustment switch	9
		→	S48	ASR switch	1
		→	S57	Differential lock switch	1
		→	S81	Rear window defroster pushbutton	1
		→	S85	Driver interior lighting pushbutton	1
		→	S87	Auxiliary heater switch	1
		→	S90	Roof fan switch	1
		→	S92	Panic alarm button	1
		→	S99	ATA [EDW] towing/interior motion sensor button	1
		→	S100	Additional heat exchanger double-contact pushbutton	1
		→	S107	Front passenger seat heater switch	1
		→	S119.1	Fog light switch	1
		→	S124	Reading lamp switch	1
		→	S126	Interior pushbutton	1
		→	S137	Roof AC switch	1
		→	S138	Temperature switch	9
		→	X79	Frame/waistrail connector	2
		→	X234	Cigar lighter illumination plug connection	3
J79	FWH/waistrail (next to firewall rubber grommet)	→	A12	Electrical center	5.4
	Connector sleeve, terminal 58L	→	E25e9	Left side light	10
		→	E67e8	Left tail light	2
		→	K135	Daytime running lamps terminal 58L	1.1

				relay	
J148	FWH/waistrail (next to firewall rubber grommet)	→	A12	Electrical center	5.13
	Circuit 56b connector sleeve	→	E25e64	Left low beam	7
		→	K68	Daytime running lamps relay	1 2
		→	K69	Daytime running lamps relay	2
		→	X79	Frame/waistrail connector	13
J356	FWH (close to left headlight)	→	E25	Left headlamp	5
	Headlamp range adjustment connector sleeve	→	E26	Right headlamp	5
		→	X79	Frame/waistrail connector	5
J446	FWH/waistrail (next to firewall rubber grommet)	→	E25	Left headlamp	1
	Circuit 58 connector sleeve	→	E26	Right headlamp	1
		→	J33	Circuit 58 connector sleeve	
		→	J144	Side marker light connector sleeve	
		→	J145	Side marker light connector sleeve	
		→	K140	Daytime running lamps circuit 58 relay	3 5
		→	P15	Instrument cluster	2.7
		→	X26	Left rear license plate lighting contact plate 2-pin	1
		→	X45	Frame/roof connector (standard)	3 4

MODEL XD1, XD2, XD3, XD4, XD5, XD6, XD7, YD1, YD2, YD3, YD4, YD5, YD6, YD7, WD1, WD2, WD3, WD6, WD7

MODEL 903.61 /66 /67, 904.61 /66 with CODE (ZU7) National version for Canada

MODEL 903.61 /66 /67, 904.61 /66 with CODE (ZU8) National version for USA

MODEL 903.61 /62 /66 /67, 904.61 /62 /66 with CODE (ZU9) National version for Mexico

PE82.00-D-2500C	Wiring diagram interior sockets	<p>MODEL XD1, XD2, XD3, XD4, XD5, XD6, XD7, YD1, YD2, YD3, YD4, YD5, YD6, YD7, WD1, WD2, WD3, WD6, WD7</p> <p>MODEL 903.61 /66, 67, 904.61 /66 with CODE (EK1) terminal strip for electrical connection at driver seat frame with CODE (ES5) 12V socket in instrument panel with CODE (ZU7) national version for Canada</p> <p>MODEL 903.61 /66, 67, 904.61 /66 with CODE (EK1) terminal strip for electrical connection at driver seat frame with CODE (ES5) 12V socket in instrument panel with CODE (ZU8) national version for USA</p> <p>MODEL 903.61 /62 /66 67, 904.61 62 /66 with CODE (EK1) terminal strip for electrical connection to driver seat frame with CODE (ES5) 12V socket in instrument panel with CODE (ZU9) national version for Mexico</p>	PE82.00-D-2500C
PE82.10-D-2000E	Wiring diagram of exterior lights	<p>MODEL XD1, XD2, XD3, XD4, XD5, XD6, XD7, YD1, YD2, YD3, YD4, YD5, YD6, YD7, WD1, WD2, WD3, WD6, WD7</p> <p>MODEL 903.61 /66 /67, 904.61</p>	PE82.10-D-2000E

		<p>/66 with CODE (ZU7) National version for Canada MODEL 903.61 /66 /67, 904.61 /66</p> <p>with CODE (ZU8) National version for USA MODEL 903.61 /62 /66 /67, 904.61 /62 /66</p> <p>with CODE (ZU9) National version for Mexico</p>	
PE82.10-D-2100F	Wiring diagram of daytime running lights	<p>MODEL XD1, XD2, XD3, XD4, XD5, XD6, XD7, YD1, YD2, YD3, YD4, YD5, YD6, YD7, WD1, WD2, WD3, WD6, WD7</p> <p>MODEL 903.61 /66 /67, 904.61 /66</p> <p>with CODE (L05) Automatic daytime running lamps</p> <p>with CODE (ZU7) National version for Canada MODEL 903.61 /66 /67, 904.61 /66</p> <p>with CODE (L05) Automatic daytime running lamps</p> <p>with CODE (ZU8) National version for USA</p>	PE82.10-D-2100F
PE82.10-D-2200D	Wiring diagram turn signal/hazard warning lamps	<p>MODEL XD1, XD2, XD3, XD4, XD5, XD6, XD7, YD1, YD2, YD3, YD4, YD5, YD6, YD7, WD1, WD2, WD3, WD6, WD7</p> <p>MODEL 903.61 /66 /67, 904.61 /66</p> <p>with CODE (ZU7) National version for Canada MODEL 903.61 /66 /67, 904.61 /66</p> <p>with CODE (ZU8) National version for USA MODEL 903.61 /62 /66 /67, 904.61 /62 /66</p> <p>with CODE (ZU9) National version for Mexico</p>	PE82.10-D-2200D
PE82.10-D-2300B	Wiring diagram of stop lamp	<p>MODEL YD1, YD2, YD3, YD4, YD5, YD6, YD7, WD1, WD2, WD3, WD6, WD7</p> <p>MODEL 903.61 /66 /67, 904.61 /66</p> <p>with CODE (LB5) Center high-</p>	PE82.10-D-2300B

		<p>mounted stop lamp with CODE (ZU7) National version for Canada MODEL 903.61 /66 /67, 904.61 /66</p> <p>with CODE (LB5) Center high- mounted stop lamp with CODE (ZU8) National version for USA MODEL 903.61 /66 /67, 904.61 /66</p> <p>with CODE (LB5) Center high- mounted stop lamp with CODE (ZU9) National version for Mexico</p>	
PE82.10-D-2400C	Wiring diagram for side marker lamps/end-outline marker lamps	<p>MODEL XD1, XD2, XD3, XD4, XD5, XD6, XD7, YD1, YD2, YD3, YD4, YD5, YD6, YD7, WD1, WD2, WD3, WD6, WD7 MODEL 903.61 /66 /67, 904.61 /66</p> <p>with CODE (LB1) Side-marker lamps with CODE (ZU7) National version for Canada MODEL 903.61 /66 /67, 904.61 /66</p> <p>with CODE (LB1) Side-marker lamps with CODE (ZU8) National version for USA MODEL 903.61 /62 /66 67, 904.61 62 /66</p> <p>with CODE (LB1) side-marker lamp with CODE (ZU9) National version for Mexico</p>	PE82.10-D-2400C
PE82.10-D-2501A	Wiring diagram of fog lights	<p>MODEL XD1, XD2, XD3, XD4, XD5, XD6, XD7, YD1, YD2, YD3, YD4, YD5, YD6, YD7, WD1, WD2, WD3, WD6, WD7 MODEL 903.61 /66 /67, 904.61 /66</p> <p>with CODE (L16) Halogen front fog lamps with CODE (ZU7) National version for Canada MODEL 903.61 /66 /67, 904.61 /66</p> <p>with CODE (L16) Halogen front</p>	PE82.10-D-2501A

		<p>fog lamps with CODE (ZU8) National version for USA MODEL 903.61 /62 /66 /67, 904.61 /62 /66 with CODE (L16) Halogen front fog lamps with CODE (ZU9) National version for Mexico</p>	
PE82.20-D-2000L	Wiring diagram interior lights	<p>MODEL XD1, XD2, XD3, XD4, XD5, XD6, XD7, YD1, YD2, YD3, YD4, YD5, YD6, YD7, WD1, WD2, WD3, WD6, WD7 MODEL 903.61 /66 /67, 904.61 /66 with CODE (ZU7) National version for Canada MODEL 903.61 /66 /67, 904.61 /66 with CODE (ZU8) National version for USA MODEL 903.61 /62 /66 /67, 904.61 /62 /66 with CODE (ZU9) National version for Mexico</p>	PE82.20-D-2000L
PE82.20-D-2000M	Wiring diagram interior lights	<p>MODEL YD1##, YD2##, YD3##, YD4##, YD5##, YD6##, YD7##, WD1##, WD2##, WD3##, WD6##, WD7## ### up to 605787 up to 28.11.03 MODEL 903.61# /66# /67#, 904.61# /66# ## up to 605787 up to 28.11.03 with CODE (L63) dome lamp for load compartment with CODE (ZU7) National version for Canada MODEL 903.61# /66# /67#, 904.61# /66# ## up to 605787 up to 28.11.03 with CODE (L63) dome lamp for load compartment with CODE (ZU8) National version for USA MODEL 903.61# /66# /67#, 904.61# /66# ## up to 605787 up to 28.11.03 with CODE (L63) dome lamp for load compartment with CODE (ZU9) National</p>	PE82.20-D-2000M

		version for Mexico	
PE82.20-D-2000N	Wiring diagram interior lights	<p>MODEL YD1##, YD2##, YD3##, YD4##, YD5##, YD6##, YD7##, WD1##, WD2##, WD3##, WD6##, WD7## ### as from 605788 as from 1.12.03</p> <p>MODEL 903.61# /66# /67#, 904.61# /66# ## as from 605788 as from 1.12.03</p> <p>with CODE (L63) dome lamp for load compartment</p> <p>with CODE (ZU7) National version for Canada</p> <p>MODEL 903.61# /66# /67#, 904.61# /66# ## as from 605788 as from 1.12.03</p> <p>with CODE (L63) dome lamp for load compartment</p> <p>with CODE (ZU8) National version for USA</p> <p>MODEL 903.61# /66# /67#, 904.61# /66# ## as from 605788 as from 1.12.03</p> <p>with CODE (L63) dome lamp for load compartment</p> <p>with CODE (ZU9) National version for Mexico</p>	PE82.20-D-2000N
PE82.20-D-2100C	Wiring diagram of entrance/exit lamps	<p>MODEL XD1, XD2, XD3, XD4, XD5, XD6, XD7, YD1, YD2, YD3, YD4, YD5, YD6, YD7, WD1, WD2, WD3, WD6, WD7</p> <p>MODEL 903.61 /66 /67, 904.61 /66</p> <p>with CODE (LB9) illuminated exit</p> <p>with CODE (ZU7) National version for Canada</p> <p>MODEL 903.61 /66 /67, 904.61 /66</p> <p>with CODE (LB9) illuminated exit</p> <p>with CODE (ZU8) National version for USA</p>	PE82.20-D-2100C
PE82.30-D-2000D	Wiring diagram of windscreen wiper	<p>MODEL XD1, XD2, XD3, XD4, XD5, XD6, XD7, YD1, YD2, YD3, YD4, YD5, YD6, YD7, WD1, WD2, WD3, WD6, WD7</p> <p>MODEL 903.61 /66 /67, 904.61 /66</p> <p>with CODE (ZU7) National version for Canada</p>	PE82.30-D-2000D

		<p>MODEL 903.61 /66 /67, 904.61 /66 with CODE (ZU8) National version for USA MODEL 903.61 /62 /66 /67, 904.61 /62 /66 with CODE (ZU9) National version for Mexico</p>	
PE82.30-D-2000F	Wiring diagram of windscreen wiper	<p>MODEL XD1##, XD2##, XD3##, XD4##, XD5##, XD6##, XD7##, YD1##, YD2##, YD3##, YD4##, YD5##, YD6##, YD7##, WD1##, WD2##, WD3##, WD6##, WD7## ### as from 568505 as from 26.9.03 with CODE (FM2) tinted windshield, heated with rain sensor MODEL 903.61# /66# /67#, 904.61# /66# ## as from 568505 as from 26.9.03 with CODE (FM2) tinted windshield, heated with rain sensor with CODE (ZU7) National version for Canada MODEL 903.61# /66# /67#, 904.61# /66# ## as from 568505 as from 26.9.03 with CODE (FM2) tinted windshield, heated with rain sensor with CODE (ZU8) National version for USA MODEL 903.61# /62# /66# /67#, 904.61# /62# /66# ## as from 568505 as from 26.9.03 with CODE (FM2) tinted windshield, heated with rain sensor with CODE (ZU9) National version for Mexico</p>	PE82.30-D-2000F
PE82.60-D-2000E	Wiring diagram radio	<p>MODEL XD1, XD2, XD3, XD4, XD5, XD6, XD7, YD1, YD2, YD3, YD4, YD5, YD6, YD7, WD1, WD2, WD3, WD6, WD7 MODEL 903.61 /66 /67, 904.61 /66 with CODE (E77) Additional stereo speakers</p>	PE82.60-D-2000E

		<p>with CODE (EF5) Sound 10 radio with CODE (EF7) Sound 30 radio with CODE (ZU7) National version for Canada MODEL 903.61 /66 /67, 904.61 /66 with CODE (E77) Additional stereo speakers with CODE (EF5) Sound 10 radio with CODE (EF7) Sound 30 radio with CODE (ZU8) National version for USA MODEL 903.61 /62 /66 /67, 904.61 /62 /66 with CODE (EF5) Sound 10 radio with CODE (ZU9) National version for Mexico</p>	
<p>PE82.70-D- 2000D</p>	<p>Telephone (TEL) wiring diagram</p>	<p>MODEL XD1, XD2, XD3, XD4, XD5, XD6, XD7, YD1, YD2, YD3, YD4, YD5, YD6, YD7, WD1, WD2, WD3, WD6, WD7 MODEL 903.61 /66 /67, 904.61 /66 with code (JV4) Portable CTEL telephone preinstallation with code (EV7) Preinstallation for hands-free system with code (ZU7) National version for Canada MODEL 903.61 /66 /67, 904.61 /66 with code (JV4) Portable CTEL telephone preinstallation with code (EV7) Preinstallation for hands-free system with code (ZU8) National version for USA</p>	<p>PE82.70-D- 2000D</p>

To display wiring diagrams, you need a
 JAVA 1.1 capable Browser like e.g. "Microsoft Internet Explorer 4.0"
 or
 "Netscape Navigator 4.05" and higher with AWT 1.1 support

F54	Heated adjustable exterior mirror fuse (10 A)
J111	Exterior mirror heater connector sleeve
J111	Exterior mirror heater connector sleeve
J31	Circuit 15, fused, connector sleeve
J357	Circuit 15, fused, connector sleeve
J376	Circuit 31 connector sleeve
J376	Circuit 31 connector sleeve
M11	Driver mirror adjustment
M11.1	Mirror up/down adjustment motor
M11m1	Mirror up/down adjustment motor
M11m2	Mirror in/out adjustment motor
M11r1	Mirror heater
M12	Right mirror adjustment
M12.1	Mirror up/down adjustment motor
M12m1	Mirror up/down adjustment motor
M12m2	Mirror in/out adjustment motor
M12r1	Mirror heater
S101	Adjustable exterior mirror switch
S101	Adjustable exterior mirror switch
W8	Ground point waistrail
W8	Ground point waistrail
X201	Right mirror

	adjustment connector
X201	Right mirror adjustment connector
X79	Frame/waistrail plug connection

PE88.79-D-2000-60F	Legend of wiring diagram of outside rearview mirrors	<p>MODEL XD1, XD2, XD3, XD4, XD5, XD6, XD7, YD1, YD2, YD3, YD4, YD5, YD6, YD7, WD1, WD2, WD3, WD6, WD7</p> <p>MODEL 903.61 /66 /67, 904.61 /66 with CODE (F68) Electrically adjustable and heated outside rearview mirror, left and right with CODE (ZU7) National version for Canada</p> <p>MODEL 903.61 /66 /67, 904.61 /66 with CODE (F68) Electrically adjustable and heated outside rearview mirror, left and right with CODE (ZU8) National version for USA</p> <p>MODEL 903.61 /62 /66 /67, 904.61 /62 /66 with CODE (F68) Electrically adjustable and heated outside rearview mirror, left and right with CODE (ZU9) National version for Mexico</p>	
--------------------	--	--	--

Code	Designation	Coordinate
F54	Heated and adjustable exterior mirror fuse (10 A)	20H
J31	Circuit 15 fused connector sleeve	20L
J111	Exterior mirror heater connector sleeve	2E 8G
J357	Circuit 15 fused connector sleeve	18E
J376	Tml. 31 connector sleeve	1E 9G
M11	Driver mirror adjustment	3L
M11M1	Mirror up/down adjustment motor	5K
M11M2	Mirror in/out adjustment motor	5K
M11R1	Mirror heater	2K
M11.1	Driver mirror adjustment connector	1H
M12	Right mirror adjustment	18L

M12M12m1	Mirror up/down adjustment motor	17K
M12M2	Mirror in/out adjustment motor	17L
M12R1	Mirror heater	19K
M12.1	Front passenger mirror adjustment connector	15H
S101	Adjustable exterior mirror switch	4A 12A
W8	Ground point waistrail	1A 19E
X79	Frame/waistrail connector	20E
X201	Right mirror adjustment connector	1D 15D

GF00.19-D-3100-48C

Arrangement and assignment of terminal block connectors outside mirrors

Models XD1, XD2, XD3, XD4, XD5, XD6, XD7, YD1, YD2, YD3, YD4, YD5, YD6, YD7, WD1, WD2, WD3, WD6, WD7
Models 903.61/66/67, 904.61/66
with code (F68) Exterior, heated+electrically adjustable left and right rearview mirrors
with code (ZU7) National version for Canada
Models 903.61/66/67, 904.61/66
with code (F68) Exterior, heated+electrically adjustable left and right rearview mirrors
with code (ZU8) National version for USA
Models 903.61/62/66/67, 904.61/62/66
with code (F68) Exterior, heated+electrically adjustable left and right rearview mirrors
with code (ZU9) National version for Mexico

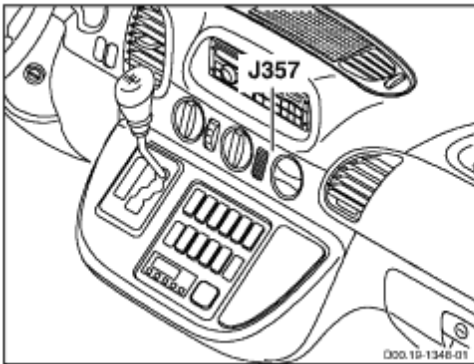

D00.19-1346-01

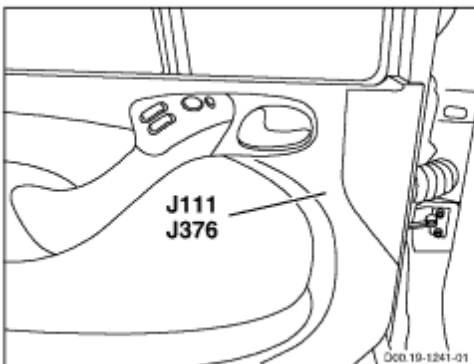

D00.19-1241-01

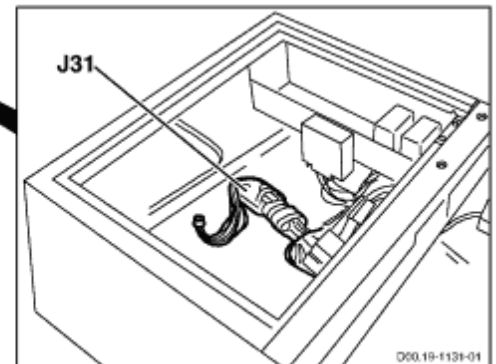
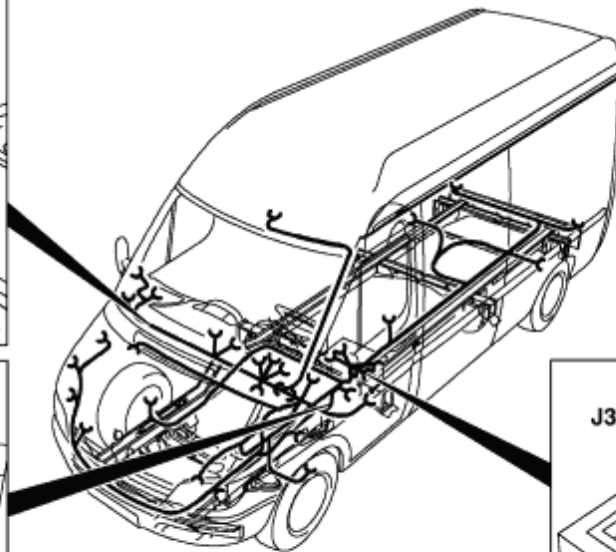

D00.19-1131-01

D00.19-1390-09

Terminal block	Designation		Component	Designation	Connector Pin
J31	FWH/seat frame (behind rubber grommet)	→	F5	ABS terminal 15 fuse	1
	Circuit 15 fused connector sleeve	→	F52	Front passenger door power window fuse (25 A)	1
		→	F53	Driver door power window fuse (25 A)	1
		→	F54	Heated and adjustable exterior mirror fuse (10 A)	1
		→	F86	EDW circuit 15 fuse (7.5 A)	1
		→	F127	Differential lock fuse (15 A)	1
		→	F128	Driver, passenger seat heater fuse (15 A)	1
		→	F139	Additional heater fuse (10 A)	1
		→	F150	Roof fan fuse (15 A)	1
		→	K70	Circuit 15 relay for optional equipment	1
J111	TLS (close to M11.1)	→	M11.1	Driver mirror adjustment connector	1
	Exterior mirror heater connector sleeve	→	S101	Adjustable exterior mirror switch	7
		→	X201	Right mirror adjustment connector	2
J357	WWH (middle of instrument panel)	→	M12.1	Front passenger mirror adjustment connector	1
	Circuit 15 fused connector sleeve	→	X79	Frame/waistrail connector	9
		→	X201	Right mirror adjustment connector	2
J376	TLS (close to M11.1)	→	M11.1	Driver mirror adjustment connector	2
	Tml. 31 connector sleeve	→	S101	Adjustable exterior mirror switch	6
		→	X201	Right mirror adjustment connector	1

PE67.29-D-2000-99E

[Display in a separate window](#)

To display wiring diagrams, you need a
JAVA 1.1 capable Browser like e.g. "Microsoft Internet Explorer 4.0"
or
"Netscape Navigator 4.05" and higher with AWT 1.1 support

E60 Right rear window defroster
E61 Left rear window defroster
F63 Rear window defroster fuse (30 A)
J16 Circuit 30 connector sleeve
J19 Circuit 61 connector sleeve
J22 Circuit 15, fused, connector sleeve
J46 Circuit 58 connector sleeve
J60 Circuit 15, fused, connector sleeve
K3 Rear window defroster relay module
K3 Rear window defroster relay module
S81 Rear window defroster pushbutton
W5 Ground point seat frame
W6 Ground point taillamp
W6 Ground point taillamp
W8 Ground point waistrail
X29 Left rear contact plate, 3-pin
X32 Right rear rear window defroster contact plate, 2-pin
X34 Right rear contact plate, 3-pin
X80 Frame/waistrail plug connection

1

PE67.29-D-2000-60E	Legend for wiring diagram of heated rear window	<p>MODEL YD1##, YD2##, YD3##, YD4##, YD5##, YD6##, YD7##, WD1##, WD2##, WD3##, WD6##, WD7## ### up to 605787 up to 28.11.03</p> <p>MODEL 903.66# /67#, 904.66# ## up to 605787 up to 28.11.03</p> <p>with CODE (H22) Heated rear window</p> <p>with CODE (ZU7) National version Canada</p> <p>MODEL 903.66# /67#, 904.66# ## up to 605787 up to 28.11.03</p> <p>with CODE (H22) Heated rear window</p> <p>with CODE (ZU8) National version USA</p> <p>MODEL 903.66# /67#, 904.66# ## up to 605787 up to 28.11.03</p> <p>with CODE (H22) Heated rear window</p> <p>with CODE (ZU9) National version Mexico</p>	
--------------------	---	---	--

Code	Designation	Coordinate
E60	Right heated rear window	4L
E61	Left heated rear window	8L
F63	Heated rear window fuse (30 A)	1H
J16	Circuit 30 connector sleeve	1L
J19	Circuit 61 connector sleeve	11E
J22	Circuit 15 fused connector sleeve	10E
J46	Circuit 58 connector sleeve	11G
J60	Circuit 15 fused connector sleeve	1E
K3	Heated rear window relay	4A 11A
S81	Heated rear window button	11L
W5	Seat frame ground point	2E
W6	Ground point taillamp	6D 9E

W8	Waistrail ground point	12H
X29	Left rear contact plate, 3-pin	7H
X32	Heated rear window right rear contact plate, 2-pin	2H
X34	Right rear contact plate, 3-pin	5H
X80	Frame/waistrail connector	9H

GF00.19-D-3100-28C

Arrangement and assignment of terminal block connectors rear window defroster

Models YD1, YD2, YD3, YD4, YD5, YD6, YD7, WD1, WD2, WD3, WD6, WD7
Models 903.66 /67, 904.66 with code (FY1) Anti-theft alarm system with interior motion sensor, towing sensor and rechargeable horn with code (H22) Heated rear window with code (ZU7) National version for Canada
Models 903.66/67, 904.66 with code (FY1) Anti-theft alarm system with interior motion sensor, towing sensor and rechargeable horn with code (H22) Heated rear window with code (ZU8) National version for USA
Models 903.66/67, 904.66 with code (H22) Heated rear window with code (ZU9) National version for Mexico

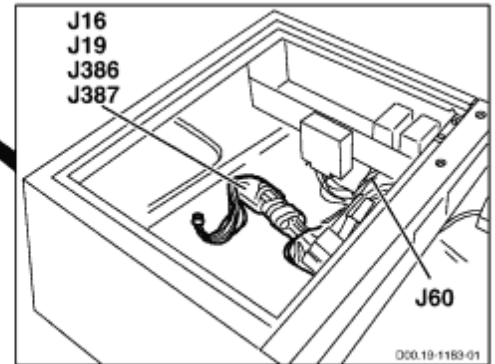
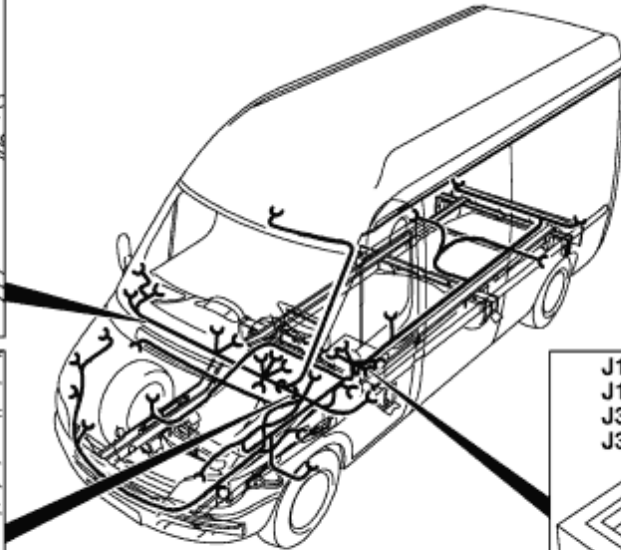
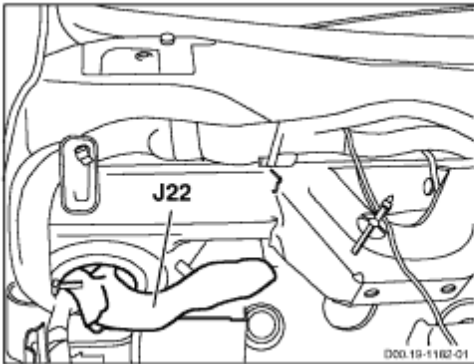
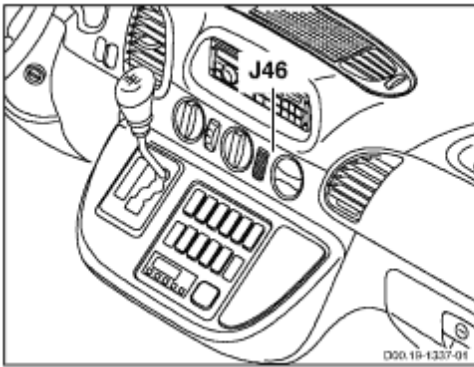

D00.19-1367-09

Terminal Designation

Compo- Designation

Con-

block			nent		nector Pin
J16	FWH/seat frame (behind rubber grommet)	→	F6	ABS circuit 30 fuse	1
	Circuit 30 connector sleeve	→	F7	ABS circuit 30 fuse	1
		→	F9	Additional heater fuse (25 A)	1
		→	F11	Instrument cluster fuse (7.5 A)	1
		→	F40	Daytime running lamps fuse	1
		→	F43	Radio remote control fuse (10 A)	1
		→	F44	Central locking fuse (25 A)	1
		→	F62	Interior light fuse (15 A)	1
		→	F63	Heated rear window fuse (30 A)	1
		→	F98	Warm water heater stage 1 blower fuse (10 A)	1
		→	F101	Warm air additional heater fuse (7.5 A)	1
		→	F114	Additional heat exchanger fuse (25 A)	1
		→	F119	Air conditioning additional fan fuse (30 A)	1
		→	F138	Circuit 15 fuse (10 A)	1
		→	F140.3	Circuit 30 fuse (125 A)	2
		→	F143	Additional heater fuse (25 A)	1
		→	F148	Daytime running lamps relay fuse (10 A)	1
		→	F149	Roof AC fuse (40 A)	1
		→	F151	Fog lamp fuse (7.5 A)	1
		→	F153	Trailer socket fuse (25 A)	1
		→	F154	Instrument panel socket fuse (15 A)	1
		→	J327	Circuit 30 unfused connector sleeve	
		→	K26	Circuit D+ relay	1
J19	FWH/seat frame (behind rubber grommet)	→	A8	Central locking control module	1.8
	Circuit 61 connector sleeve	→	F66	Additional battery isolating relay fuse (15 A)	1
		→	F70	D+ relay fuse (15 A)	2

		→	K3	Heated rear window relay	4
		→	K78	Circuit D+ body manufacturer relay	4
		→	K135	Daytime running lamps terminal 58L relay	2
		→	K136	Daytime running lamps terminal 58R relay	2
		→	K140	Daytime running lamps circuit 58 relay	2
		→	X82	Frame/waistrail connector	13
J22	FWH/waistrail (next to firewall rubber grommet)	→	A12	Electrical center	4.7
	Circuit 15 fused connector sleeve	→	A62	WSP control unit	7
		→	H17	Horn	2
		→	K37	Horn relay	4
		→	K70	Circuit 15 relay for optional equipment	2
		→	K103	Circulation pump relay	3
		→	K138	Circuit 15 relay	2
		→	X79	Frame/waistrail connector	1
		→	X80	Frame/waistrail connector	3
J46	WWH (middle of instrument panel)	→	A9	Radio	1.A6
	Circuit 58 connector sleeve	→	A40	EWM control unit	2
		→	A71	Heater timer	1
		→	A81	Air conditioning pushbutton control and operating unit	1.9
		→	E104	Ashtray lighting	1
		→	S12	Driver seat heater switch	1
		→	S25	Headlamp range adjustment switch	9
		→	S48	ASR switch	1
		→	S57	Differential lock switch	1
		→	S81	Rear window defroster pushbutton	1
		→	S85	Driver interior lighting pushbutton	1
		→	S87	Auxiliary heater switch	1
		→	S90	Roof fan switch	1
		→	S92	Panic alarm button	1
		→	S99	ATA [EDW] towing/interior motion	1

				sensor button	
		→	S100	Additional heat exchanger double-contact pushbutton	1
		→	S107	Front passenger seat heater switch	1
		→	S119.1	Fog light switch	1
		→	S124	Reading lamp switch	1
		→	S126	Interior pushbutton	1
		→	S137	Roof AC switch	1
		→	S138	Temperature switch	9
		→	X79	Frame/waistrail connector	2
		→	X234	Cigar lighter illumination plug connection	3
J60	FWH/seat frame (in front of K3)	→	F63	Heated rear window fuse (30 A)	2
	Circuit 15 fused connector sleeve	→	K3	Heated rear window relay	1 6
		→	K86	Right heated rear window relay, ATA [EDW]	5
		→	K87	Left heated rear window relay, ATA [EDW]	5
J386	FWH/seat frame (behind rubber grommet)	→	A82	EDW control unit	2.3
	Right rear window defroster connector sleeve, ATA	→	K86	Right rear window defroster relay, ATA	1
		→	X32	Rear window defroster right rear contact plate 2-pin	1
		→	X34	Right rear contact plate 3-pin	3
J387	FWH/seat frame (behind rubber grommet)	→	A82	EDW control unit	2.2
	Left rear window defroster connector sleeve, ATA	→	K87	Left rear window defroster relay, ATA	1
		→	X29	Left rear contact plate 3-pin	1

PE67.29-D-2000-99F

[Display in a separate window](#)

To display wiring diagrams, you need a
JAVA 1.1 capable Browser like e.g. "Microsoft Internet Explorer 4.0"
or
"Netscape Navigator 4.05" and higher with AWT 1.1 support

A82	ATA 2 control module
E60	Right rear window defroster
E61	Left rear window defroster
F63	Rear window defroster fuse (30 A)
J16	Circuit 30 connector sleeve
J19	Circuit 61 connector sleeve
J22	Circuit 15, fused, connector sleeve
J386	Right rear window defroster connector sleeve, ATA 2
J387	Left rear window defroster connector sleeve, ATA 2
J46	Circuit 58 connector sleeve
J60	Circuit 15, fused, connector sleeve
J60	Circuit 15, fused, connector sleeve
J60	Circuit 15, fused, connector sleeve
K3	Rear window defroster relay module
K3	Rear window defroster relay module
K3	Rear window defroster relay module
K86	Right rear window defroster relay, ATA 2
K87	Left rear window defroster relay, ATA 2
S81	Rear window defroster pushbutton
W5	Ground point seat

	frame
W5	Ground point seat frame
W5	Ground point seat frame
W6	Ground point taillamp
W6	Ground point taillamp
W8	Ground point waistrail
X29	Left rear contact plate, 3-pin
X32	Right rear rear window defroster contact plate, 2-pin
X34	Right rear contact plate, 3-pin
X80	Frame/waistrail plug connection

PE67.29-D-2000-60F	Legend for wiring diagram of heated rear window	<p>MODEL YD1##, YD2##, YD3##, YD4##, YD5##, YD6##, YD7##, WD1##, WD2##, WD3##, WD6##, WD7## ### up to 605787 up to 28.11.03</p> <p>MODEL 903.66# /67#, 904.66# ## up to 605787 up to 28.11.03</p> <p>with CODE (FY1) Anti-theft alarm with interior motion sensor, towing sensor and rechargeable horn</p> <p>with CODE (H22) Heated rear window</p> <p>with CODE (ZU7) National version Canada</p> <p>MODEL 903.66# /67#, 904.66# ## up to 605787 up to 28.11.03</p> <p>with CODE (FY1) Anti-theft alarm with interior motion sensor, towing sensor and rechargeable horn</p> <p>with CODE (H22) Heated rear window</p> <p>with CODE (ZU8) National version USA</p>	
--------------------	---	--	--

Code	Designation	Coordinate
A82	EDW control unit	11L
E60	Right heated rear window	4L
E61	Left heated rear window	16L
F63	Heated rear window fuse (30 A)	1H
J16	Circuit 30 connector sleeve	1L
J19	Circuit 61 connector sleeve	19E
J22	Circuit 15 fused connector sleeve	17E
J46	Circuit 58 connector sleeve	19G
J60	Circuit 15 fused connector sleeve	1E 7G 13G
J386	Right heated rear window connector sleeve, ATA [EDW]	9G
J387	Left heated rear window connector sleeve, ATA [EDW]	15E

K3	Heated rear window relay	4A 12A 19A
K86	Right heated rear window relay, ATA [EDW]	8L
K87	Left heated rear window relay, ATA [EDW]	14L
S81	Heated rear window pushbutton	18L
W5	Seat frame ground point	2E 8H 13H
W6	Ground point taillamp	6D 16E
W8	Wastrail ground point	20H
X29	Left rear contact plate, 3-pin	15H
X32	Heated rear window right rear contact plate, 2-pin	2H
X34	Right rear contact plate, 3-pin	5H
X80	Frame/wastrail connector	17H

PE67.29-D-2000-99G

[Display in a separate window](#)

To display wiring diagrams, you need a
JAVA 1.1 capable Browser like e.g. "Microsoft Internet Explorer 4.0"
or
"Netscape Navigator 4.05" and higher with AWT 1.1 support

E60	Right rear window defroster
E61	Left rear window defroster
F63	Rear window defroster fuse (30 A)
J16	Circuit 30 connector sleeve
J19	Circuit 61 connector sleeve
J22	Circuit 15, fused, connector sleeve
J46	Terminal 58 connector sleeve
J60	Circuit 15 fused connector sleeve
J486	Right rear window defroster connector sleeve
K3	Rear window defroster relay
K3	Rear window defroster relay
K147	Rear window defroster relay
S81	Rear window defroster pushbutton
W5	Ground point seat frame
W6	Ground point taillamp
W6	Ground point taillamp
W8	Ground point (waistrail)
X29	Left rear contact plate, 3-pin
X32	Right rear rear window defroster contact plate, 2-pin
X34	Right rear contact plate, 3-pin
X80	Frame/waistrail connector



PE67.29-D-2000-60G	Legend for wiring diagram of heated rear window	<p>MODEL YD1##, YD2##, YD3##, YD4##, YD5##, YD6##, YD7##, WD1##, WD2##, WD3##, WD6##, WD7## ### as of 605788 as of 1.12.03</p> <p>MODEL 903.66# /67#, 904.66# ## as of 605788 as of 1.12.03</p> <p>with CODE (H22) Heated rear window</p> <p>with CODE (ZU7) National version Canada</p> <p>MODEL 903.66# /67#, 904.66# ## as of 605788 as of 1.12.03</p> <p>with CODE (H22) Heated rear window</p> <p>with CODE (ZU8) National version USA</p> <p>MODEL 903.66# /67#, 904.66# ## as of 605788 as of 1.12.03</p> <p>with CODE (H22) Heated rear window</p> <p>with CODE (ZU9) National version Mexico</p>	
--------------------	---	---	--

Code	Designation	Coordinate
E60	Right heated rear window	7L
E61	Left heated rear window	15L
F63	Heated rear window fuse (30 A)	1H
J16	Circuit 30 connector sleeve	1L
J19	Circuit 61 connector sleeve	12E
J22	Circuit 15 fused connector sleeve	11E
J46	Circuit 58 connector sleeve	12G
J60	Circuit 15 fused connector sleeve	1E
J486	Right heated rear window relay actuation connector sleeve	10E
K3	Heated rear window relay	4A 12A
K147	Heated rear window relay	3L
S81	Heated rear window pushbutton	11L
W5	Seat frame ground point	3E

W6	Ground point taillamp	8D 15E
W8	Waistrail ground point	13H
X29	Left rear contact plate, 3-pin	13H
X32	Heated rear window right rear contact plate, 2-pin	5H
X34	Right rear contact plate, 3-pin	7H
X80	Frame/waistrail connector	10H

PE67.29-D-2000-99H

[Display in a separate window](#)

To display wiring diagrams, you need a
JAVA 1.1 capable Browser like e.g. "Microsoft Internet Explorer 4.0"
or
"Netscape Navigator 4.05" and higher with AWT 1.1 support

A82	ATA 2 control module
E60	Right rear window defroster
E61	Left rear window defroster
F63	Rear window defroster fuse (30 A)
J16	Circuit 30 connector sleeve
J19	Circuit 61 connector sleeve
J22	Circuit 15, fused, connector sleeve
J46	Terminal 58 connector sleeve
J60	Circuit 15 fused connector sleeve
J386	Right rear window defroster connector sleeve, ATA 2
J387	Left rear window defroster connector sleeve, ATA 2
J486	Right rear window defroster connector sleeve
K3	Rear window defroster relay
K3	Rear window defroster relay
K147	Rear window defroster relay
S81	Rear window defroster pushbutton
W5	Ground point seat frame
W6	Ground point taillamp
W6	Ground point taillamp
W8	Ground point (waistrail)
X29	Left rear contact plate, 3-pin
X32	Right rear rear

	window defroster contact plate, 2-pin
X34	Right rear contact plate, 3-pin
X80	Frame/waistrail connector

PE67.29-D-2000-60H	Legend for wiring diagram of heated rear window	<p>MODEL YD1##, YD2##, YD3##, YD4##, YD5##, YD6##, YD7##, WD1##, WD2##, WD3##, WD6##, WD7## ### as of 605788 as of 1.12.03</p> <p>MODEL 903.66# /67#, 904.66# ## as of 605788 as of 1.12.03</p> <p>with CODE (FZ4) Anti-theft alarm with interior motion sensor and anti-towing protection</p> <p>with CODE (H22) Heated rear window</p> <p>with CODE (ZU7) National version Canada</p> <p>MODEL 903.66# /67#, 904.66# ## as of 605788 as of 1.12.03</p> <p>with CODE (FZ4) Anti-theft alarm with interior motion sensor and anti-towing protection</p> <p>with CODE (H22) Heated rear window</p> <p>with CODE (ZU8) National version USA</p>	
--------------------	---	---	--

Code	Designation	Coordinate
A82	EDW control unit	10L
E60	Right heated rear window	7L
E61	Left heated rear window	12L
F63	Heated rear window fuse (30 A)	1H
J16	Circuit 30 connector sleeve	1L
J19	Circuit 61 connector sleeve	16E
J22	Circuit 15 fused connector sleeve	15E
J46	Circuit 58 connector sleeve	16G
J60	Circuit 15 fused connector sleeve	1E
J386	Right heated rear window connector sleeve, ATA [EDW]	10E
J387	Left heated rear window connector sleeve, ATA [EDW]	12E
J486	Right heated rear window relay actuation connector sleeve	14E
K3	Heated rear window relay	4A

		12A
K147	Heated rear window relay	3L
S81	Heated rear window pushbutton	15L
W5	Seat frame ground point	2E
W6	Ground point taillamp	8D 13E
W8	Waistrail ground point	17H
X29	Left rear contact plate, 3-pin	11H
X32	Heated rear window right rear contact plate, 2-pin	4H
X34	Right rear contact plate, 3-pin	7H
X80	Frame/waistrail connector	14H

PE82.10-D-2300-99B

[Display in a separate window](#)

To display wiring diagrams, you need a
JAVA 1.1 capable Browser like e.g. "Microsoft Internet Explorer 4.0"
or
"Netscape Navigator 4.05" and higher with AWT 1.1 support

A2	ABS control module
A12	Electrical center
A40	Electronic selector lever module control module
B127	Stop lamp switch, 6-pin
E12	Additional stop light
E67	Left rear lamp
E67h18	Left stop lamp
E68	Right rear lamp
E68h19	Right stop lamp
J8	Stop lamp connector sleeve
J15	Stop lamp connector sleeve
J277	Terminal 15 connector sleeve
J358	Tml. 31 connector sleeve
W4	Ground point firewall
X45	Frame/roof connector (standard)
X45	Frame/roof connector (standard)
X217	Frame/dash support connector

PE82.10-D-2300-60B	Legend for wiring diagram of stop lamp	<p>Models YD1, YD2, YD3, YD4, YD5, YD6, YD7, WD1, WD2, WD3, WD6, WD7</p> <p>Models 903.61 /66 /67, 904.61 /66</p> <p>with CODE (LB5) Center high-mounted stop lamp with CODE (ZU7) Canada national version</p> <p>Models 903.61 /66 /67, 904.61 /66</p> <p>with CODE (LB5) Center high-mounted stop lamp with CODE (ZU8) USA national version</p> <p>Models 903.61 /66 /67, 904.61 /66</p> <p>with CODE (LB5) Center high-mounted stop lamp with CODE (ZU9) Mexico national version</p>	
--------------------	--	---	--

Code	Designation	Coordinate
A2	ABS/ESP control unit	5A
A12	Electrical center	8A
A40	EWM control unit	6A
B127	Stop light switch 6-pin	6L
E12	Additional stop light	2A
E67	Left rear lamp	3L
E67h18	Left stop light	3K
E68	Right rear lamp	3L
E68h19	Right stop lamp	3K
J8	Stop light connector sleeve	4G
J15	Stop light connector sleeve	2G
J277	Circuit 15 connector sleeve	7G
J358	Tml. 31 connector sleeve	1E
W4	Firewall ground point	2L
X45	Frame/roof connector (standard)	1H 2E
X217	Frame/waistrail connector	6H

GF00.19-D-3100-58B

Arrangement and assignment of terminal block connectors stop lamp

Models YD1, YD2, YD3, YD4, YD5, YD6, YD7, WD1, WD2, WD3, WD6, WD7
Models 903.61/66/67, 904.61/66
with code (LB5) Center high-mounted stop lamp
with code (ZU7) National version for Canada
Models 903.61/66/67, 904.61/66
with code (LB5) Center high-mounted stop lamp
with code (ZU8) National version for USA
Models 903.61/66/67, 904.61/66
with code (LB5) Center high-mounted stop lamp
with code (ZU9) National version for Mexico

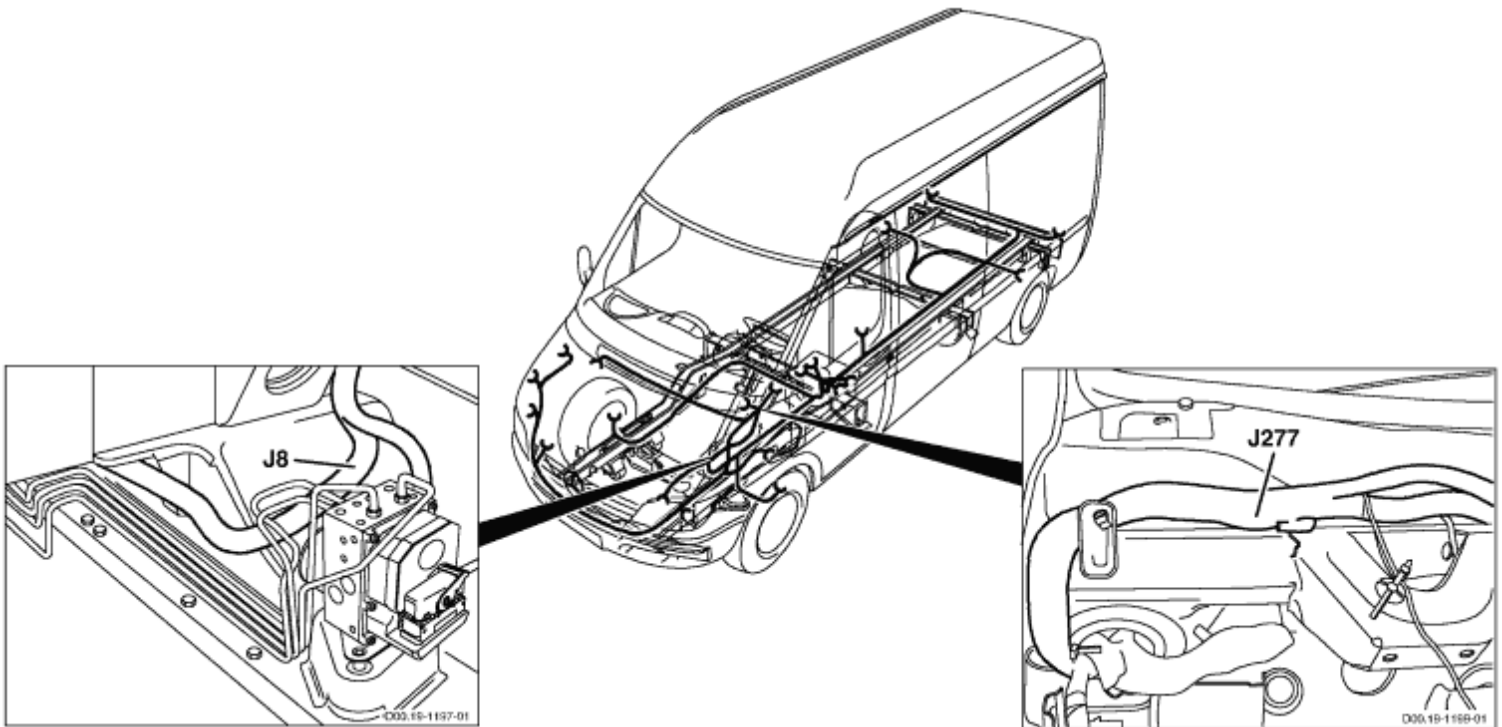

D00.19-1214-09

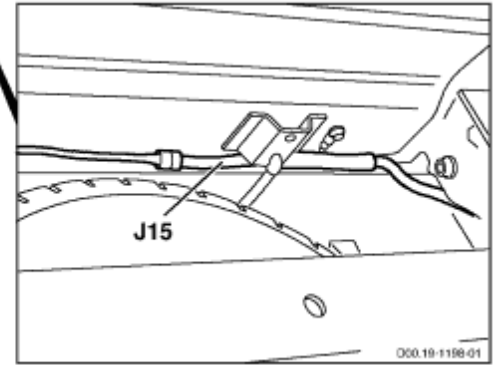
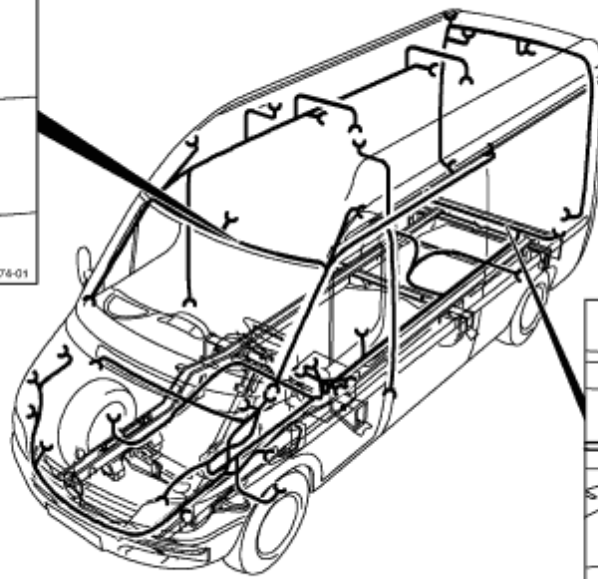
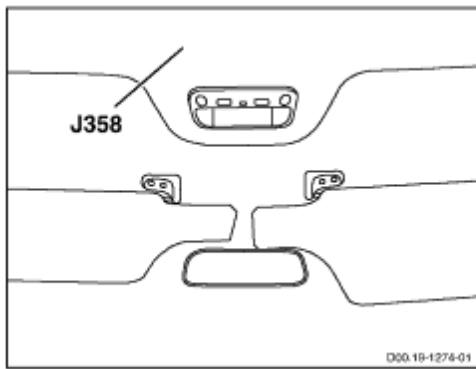

D00.19-1269-09

Terminal block	Designation		Component	Designation	Connector Pin
J8	FWH/engine compartment (behind battery)	→	A2	ABS/ESP control unit	1.32
	Stop light connector sleeve	→	A93	Trailer socket control unit	2.A
		→	B127	Stop light switch 6-pin	2.2
		→	J15	Stop light connector sleeve	
		→	X45	Frame/roof connector (standard)	2
J15	FWH (close to ground point W6)	→	E67h18	Left stop light	3
	Stop light connector sleeve	→	E68h19	Right stop lamp	3
		→	J8	Stop light connector sleeve	
J277	FWH/waistrail (behind instrument cluster)	→	A12	Electrical center	5.1
	Circuit 15 connector sleeve	→	B127	Stop light switch 6-pin	1.2 2.1
		→	P17	Diagnostic socket 16-pin	8
J358	RHW (close to interior motion sensor B104)	→	B104	Interior sensor	1
	Tml. 31 connector sleeve	→	B105	Interior sensor	1

		→	B106	Interior sensor	1
		→	E12	Additional stop light	2
		→	E38	Left front body outline lamp	2
		→	E39	Right front body outline lamp	2
		→	E43	Cab lamp	1
		→	E53	Interior light I	2
		→	E54	Interior light II	2
		→	E55	Interior light III	2
		→	E102	Interior lamp IV	2
		→	E103	Interior lamp V	2
		→	E69	Left side interior lamp	1
		→	E70	Right side interior lamp	1
		→	E73	Middle interior lamp, rear	1
		→	E74	Middle interior lamp, front	1
		→	J147	Turn signal ground connector sleeve	
		→	X45	Frame/roof connector (standard)	6
		→	X161	Reading lamp plug connection	1
		→	X171	Interior lighting connector	3

PE00.19-D-2200-99D

[Display in a separate window](#)

To display wiring diagrams, you need a
JAVA 1.1 capable Browser like e.g. "Microsoft Internet Explorer 4.0"
or
"Netscape Navigator 4.05" and higher with AWT 1.1 support

A2	ABS control unit
A4	Transmission control module
A40	EWM control module
A62	WSP control unit
A80	CDI control module
A81	Air conditioning pushbutton control module
J340	CAN-high connector sleeve
J378	CAN-low connector sleeve
J421	CAN-low connector sleeve
J422	CAN-high connector sleeve
P15	Instrument cluster
X82	Frame/waistrail plug connection
X217	Frame/waistrail plug connection

PE00.19-D-2200-60D	Legend for wiring diagram of CAN bus - engine	<p>Models XD1##, XD2##, XD3##, XD4##, XD5##, XD6##, XD7##, YD1##, YD2##, YD3##, YD4##, YD5##, YD6##, YD7##, WD1##, WD2##, WD3##, WD6##, WD7## ### up to 529900 up to 4/30/03</p> <p>Models 903.61# /66# /67#, 904.61# /66# ## up to 529900 up to 4/30/03 with code (ZU7) National version for Canada</p> <p>Models 903.61# /66# /67#, 904.61# /66# ## up to 529900 up to 4/30/03 with code (ZU8) National version for USA</p> <p>Models 903.61# /62# /66# /67#, 904.61# /62# /66# ## up to 529900 up to 4/30/03 with code (ZU9) National version for Mexico</p>	
--------------------	---	---	--

Code	Designation	Coordinate
A2	ABS/ESP control unit	7L
A4	ETC control unit	4A
A40	EWM control unit	6A
A62	WSP control unit	4L
A80	CDI control unit	2A
A81	Air conditioning pushbutton control and operating unit	9L
J340	CAN-high connector sleeve	4G
J378	CAN-low connector sleeve	3G
J421	CAN-low connector sleeve	3E
J422	CAN-high connector sleeve	4E
P15	Instrument cluster	2L
X82	Frame/waistrail connector	8G
X217	Frame/waistrail connector	6E

GF00.19-D-3100-57B	Arrangement and assignment of terminal block connectors engine CAN databus	<p>Models XD1, XD2, XD3, XD4, XD5, XD6, XD7, YD1, YD2, YD3, YD4, YD5, YD6, YD7, WD1, WD2, WD3, WD6, WD7</p> <p>Models 903.61/66/67, 904.61/66 with code (ZU7) National version for Canada</p> <p>Models 903.61/66/67, 904.61/66 with code (ZU8) National version for USA</p> <p>Models 903.61/62/66/67, 904.61/62/66 with code (ZU9) National version for Mexico</p>	
--------------------	--	--	--

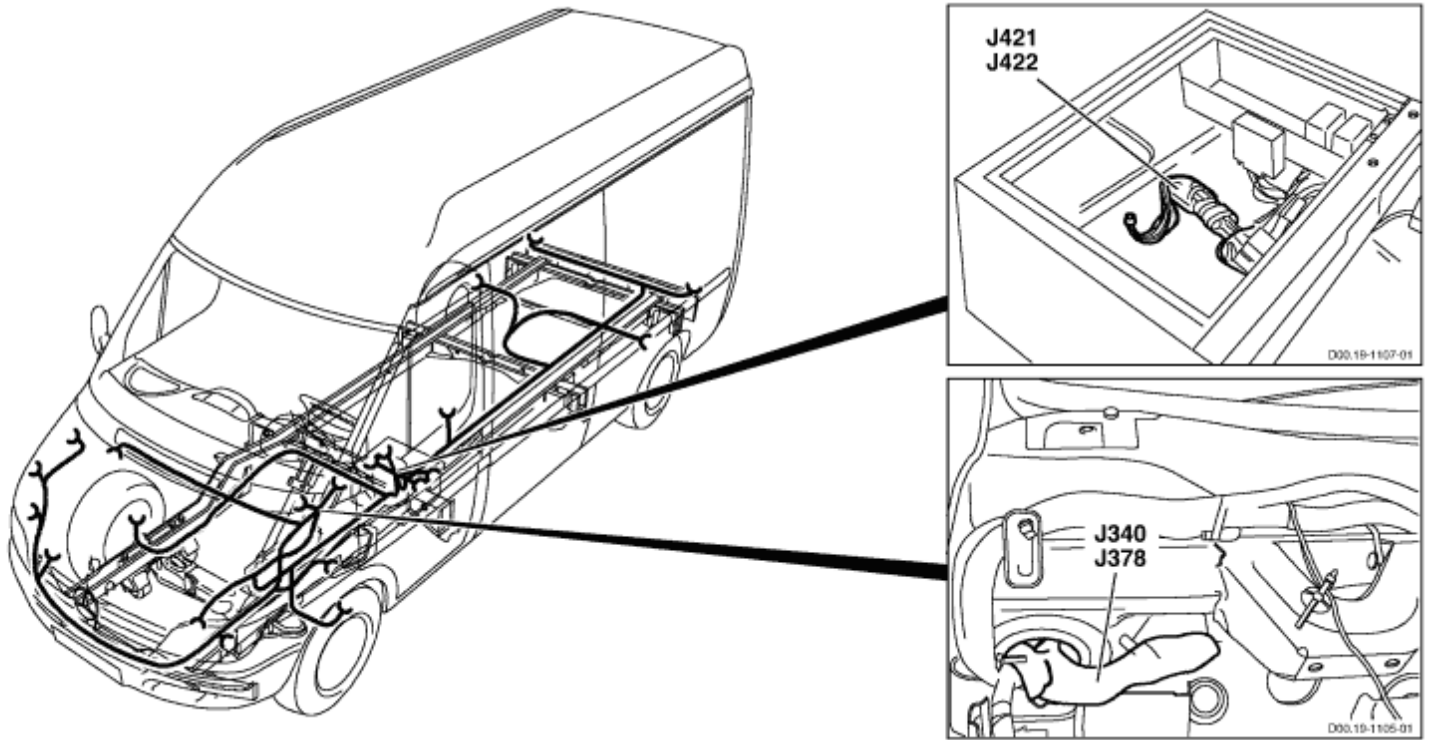

D00.19-1146-09

Terminal block	Designation		Component	Designation	Connector Pin
J340	FWH/waistrail (next to firewall rubber grommet)	→	A2	ABS/ESP control unit	1.24
up to 04/03	CAN-high connector sleeve	→	A62	WSP control unit	5

		→	J422	CAN-high connector sleeve	
		→	P15	Instrument cluster	1.18
		→	X82	Frame/waistrail connector	3
		→	X217	Frame/waistrail connector	7
J340	FWH/waistrail (next to firewall rubber grommet)	→	A2	ABS/ESP control unit	1.24
as of 05/03	CAN-high connector sleeve	→	A62	WSP control unit	5
		→	J484	CAN-high connector sleeve	
J378	FWH/waistrail (next to firewall rubber grommet)	→	A2	ABS/ESP control unit	1.40
up to 04/03	CAN-low connector sleeve	→	A62	WSP control unit	6
		→	J421	CAN-low connector sleeve	
		→	P15	Instrument cluster	1.17
		→	X82	Frame/waistrail connector	4
		→	X217	Frame/waistrail connector	8
J378	FWH/waistrail (next to firewall rubber grommet)	→	A2	ABS/ESP control unit	1.40
as of 05/03	CAN-low connector sleeve	→	A62	WSP control unit	6
		→	J485	CAN-low connector sleeve	
J421	FWH/seat frame (behind rubber grommet)	→	A4	ETC control unit	2.L
	CAN-low connector sleeve	→	A80	CDI control unit	2.12
		→	A94	CDI control unit	2.54
		→	J378	CAN-low connector sleeve up to 04/03	
		→	J485	CAN-low connector sleeve as of 05/03	
J422	FWH/seat frame (behind rubber grommet)	→	A4	ETC control unit	2.H
	CAN-high connector sleeve	→	A80	CDI control unit	2.11
		→	A94	CDI control unit	2.53
		→	J340	CAN-high connector sleeve up to 04/03	
		→	J484	CAN-high connector sleeve as of	

PE00.19-D-2200-99E

[Display in a separate window](#)

To display wiring diagrams, you need a
JAVA 1.1 capable Browser like e.g. "Microsoft Internet Explorer 4.0"
or
"Netscape Navigator 4.05" and higher with AWT 1.1 support

A2	ABS control module
A4	ETC control module
A40	Electronic selector lever module control module
A62	WSP control module
A80	CDI control module
A81	Air conditioning pushbutton control module
A94	CDI control module
B143	Steering angle sensor
J340	CAN High connector sleeve
J378	CAN Low connector sleeve
J421	CAN-low connector sleeve
J422	CAN-high connector sleeve
J484	CAN-high connector sleeve
J485	CAN-low connector sleeve
P15	Instrument cluster
X82	Frame/waistrail connector
X217	Frame/dash support connector

PE00.19-D-2200-60E	Legend for wiring diagram of CAN bus - engine	<p>Models XD1##, XD2##, XD3##, XD4##, XD5##, XD6##, XD7##, YD1##, YD2##, YD3##, YD4##, YD5##, YD6##, YD7##, WD1##, WD2##, WD3##, WD6##, WD7## ### as of 529901 as of 5/5/03</p> <p>Models 903.61#/66#/67#, 904.61#/66# ## as of 529901 as of 5/5/03 with code (ZU7) National version for Canada</p> <p>Models 903.61#/66#/67#, 904.61#/66# ## as of 529901 as of 5/5/03 with code (ZU8) National version for USA</p> <p>Models 903.61#/62#/66#/67#, 904.61#/62#/66# ## as of 529901 as of 5/5/03 with code (ZU9) National version for Mexico</p>	
--------------------	---	--	--

Code	Designation	Coordinate
A2	ABS/ESP control unit	6L
A4	ETC control unit	6A
A40	EWM control unit	8A
A62	WSP control unit	4L
A80	CDI control unit	4A
A81	Air conditioning pushbutton control and operating unit	11L
A94	CDI control unit	2A
B143	Steering angle sensor	2L
J340	CAN-high connector sleeve	3G
J378	CAN-low connector sleeve	4G
J421	CAN-low connector sleeve	5E
J422	CAN-high connector sleeve	6E
J484	CAN-high connector sleeve	9G
J485	CAN-low connector sleeve	8G
P15	Instrument cluster	9L
X82	Frame/waistrail connector	10G
X217	Frame/waistrail connector	8E



PE07.16-D-2000-99E

[Display in a separate window](#)

To display wiring diagrams, you need a
JAVA 1.1 capable Browser like e.g. "Microsoft Internet Explorer 4.0"
or
"Netscape Navigator 4.05" and higher with AWT 1.1 support

A10	Airbag control module
A12	Electrical center
A80	CDI control module
A80	CDI control module
A80	CDI control module
A80	CDI control module
B96	Pedal value sensor
B97	Kickdown switch
B101	Air mass meter
B112	Charge pressure sensor
D4	Glow time output stage
F140	Fuse box
F140.5	Circuit 30 fuse (125 A)
G2	Battery
G14	Intake air temperature sensor
J18	Circuit 15, fused, connector sleeve
J342	Circuit 30 connector sleeve
J352	Circuit 50 connector sleeve
J371	Airbag crash signal connector sleeve
J421	CAN-low connector sleeve
J422	CAN-high connector sleeve
P17	Diagnostic socket 16-pin
R13	Glow plug
R14	Glow plug
R15	Glow plug
R16	Glow plug

R17	Glow plug
S123	Switch for cruise control
S123s1	Resume from memory
S123s2	Decelerate/set
S123s3	Accelerate/set
S123s4	Off
S123s5	Control contact
S123x1	Tempomat switch connector
W4	Ground point firewall
W4	Ground point firewall
W7	Ground point (engine compartment)
Y87	Boost pressure control pressure transducer

PE07.16-D-2000-60E	Legend of wiring diagram of common rail diesel injection (CDI)	ENGINE 612.981 in MODEL XD1, XD2, XD3, XD4, XD5, XD6, XD7, YD1, YD2, YD3, YD4, YD5, YD6, YD7, WD1, WD2, WD3, WD6, WD7 ENGINE 612.981 in MODEL 903.61 /66 /67, 904.61 /66 with CODE (ZU7) National version for Canada ENGINE 612.981 in MODEL 903.61 /66 /67, 904.61 /66 with CODE (ZU8) National version for USA ENGINE 612.981 in MODEL 903.61 /62 /66 /67, 904.61 /62 /66 with CODE (ZU9) National version for Mexico vehicle wiring harness	
--------------------	--	--	--

Code	Designation	Coordinate
A10	Airbag control unit	27L
A12	Electrical center	4L
A80	CDI control unit	4A 12A 20A 28A
B96	Pedal value sensor	8L
B97	Kickdown switch	32L
B101	Mass air flow sensor	14L
B112	Boost pressure sensor	10L
D4	Glow time output stage	21L
F140	Fuse box	18J
F140.5	Circuit 30 fuse (125 A)	18G
G2	Battery	18L
G14	Charge air temperature sensor	6L
J18	Circuit 15 fused connector sleeve	27E
J342	Circuit 30 connector sleeve	2E
J352	Circuit 50 connector sleeve	4E
J371	Airbag crash signal connector sleeve	27E
J421	CAN-low connector sleeve	24E

J422	CAN-high connector sleeve	25E
P17	Diagnostic socket 16-pin	5E
R13	Glow plug	20G
R14	Glow plug	20G
R15	Glow plug	21G
R16	Glow plug	21G
R17	Glow plug	22G
S123	cruise control switch	29L
S123s1	Resume from memory	30J
S123s2	Decelerate/set	30K
S123s3	Accelerate/set	30K
S123s4	Off	30K
S123s5	Control contact	30L
S123x1	Tempomat switch connector	28H
W4	Firewall ground point	2E 17G
W7	Engine compartment ground point	22G
Y87	Boost pressure control pressure transducer	16L

GF00.19-D-3100-55B

Arrangement and assignment of terminal block connectors common rail diesel injection (CDI)

Engine 612.981 in models XD1, XD2, XD3, XD4, XD5, XD6, XD7, YD1, YD2, YD3, YD4, YD5, YD6, YD7, WD1, WD2, WD3, WD6, WD7
Engine 612.981 in models 903.61/66/67, 904.61/66 with code (ZU7) National version for Canada
Engine 612.981 in models 903.61/66/67, 904.61/66 with code (ZU8) National version for USA
Engine 612.981 in models 903.61/62/66/67, 904.61/62/66 with code (ZU9) National version for Mexico

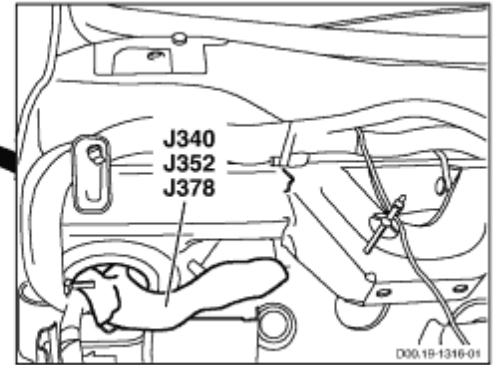
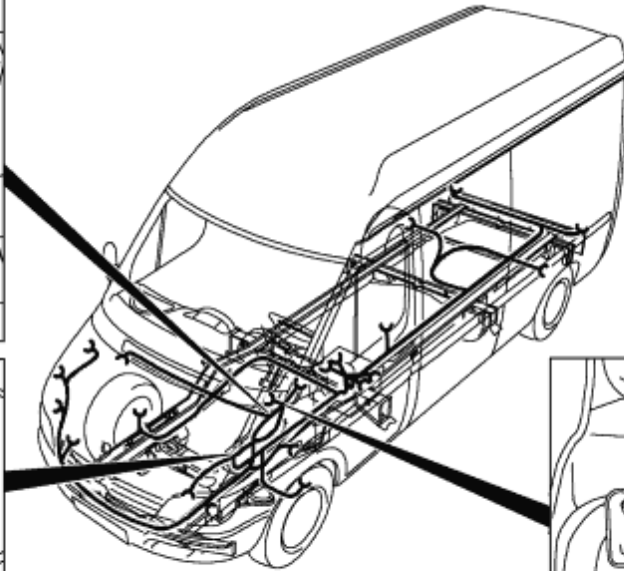
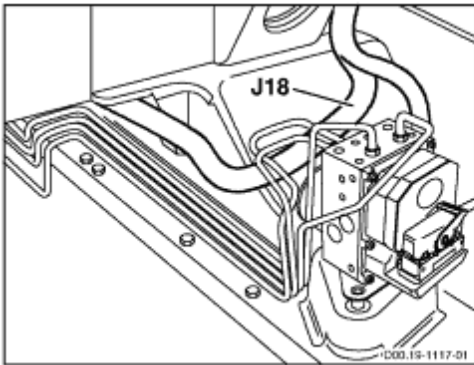
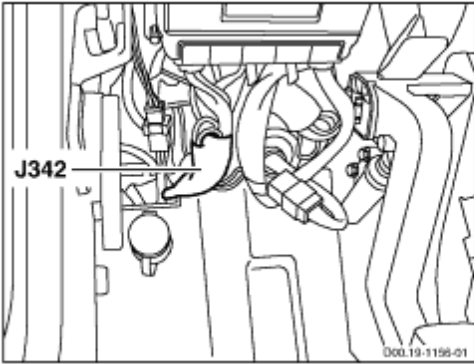

D00.19-1353-09

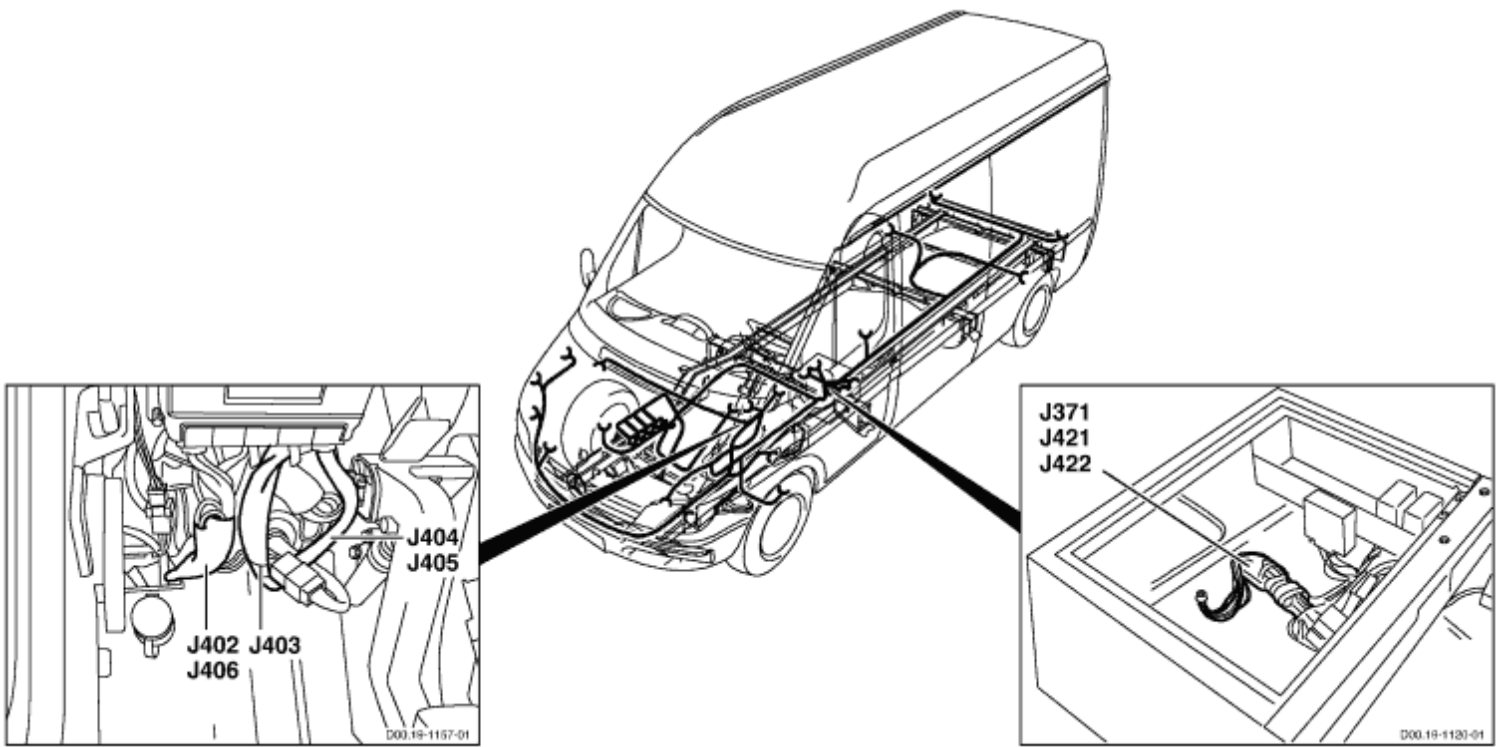

D00.19-1155-09

Terminal block	Designation		Component	Designation	Connector Pin
J18	FWH/engine compartment (behind battery)	→	A10	Airbag control unit	1.5
	Circuit 15 fused connector sleeve	→	A12	Electrical center	4.3
		→	A80	CDI control unit	2.13
		→	K79	Circuit 15 body manufacturer relay	4
		→	P15	Instrument cluster	2.10
J340	FWH/waistrail (next to firewall rubber grommet)	→	A2	ABS/ESP control unit	1.24
	CAN-high connector sleeve	→	A62	WSP control unit	5
		→	J422	CAN-high connector sleeve	
		→	P15	Instrument cluster	1.18
		→	X82	Frame/waistrail connector	3
		→	X217	Frame/waistrail connector	7
J342	FWH (close to A80.1)	→	A12	Electrical center	5.2
	Circuit 30 connector sleeve	→	A80	CDI control unit	1.7 1.8
J352	FWH/waistrail (next to firewall	→	A12	Electrical center	3.3

	rubber grommet)				
	Circuit 50 connector sleeve	→	A80	CDI control unit	3.20
		→	K61	Starter relay	1
J371	FWH/seat frame (behind rubber grommet)	→	A8	Central locking control unit	1.11
	Airbag crash signal connector sleeve	→	A10	Airbag control unit	1.20
		→	A80	CDI control unit	2.17
J378	FWH/waistrail (next to firewall rubber grommet)	→	A2	ABS/ESP control unit	1.40
	CAN-low connector sleeve	→	A62	WSP control unit	6
		→	J421	CAN-low connector sleeve	
		→	P15	Instrument cluster	1.17
		→	X82	Frame/waistrail connector	4
		→	X217	Frame/waistrail connector	8
J402	FWH (close to A80.1)	→	A12	Electrical center	4.4
	Exhaust gas recirculation connector sleeve	→	A80	CDI control unit	1.1
		→	X195	Frame/engine connector	4
J403	EWB (close to A80.4)	→	A80	CDI control unit	4.17
	Exhaust gas recirculation connector sleeve	→	B110	Engine oil sensor	2
		→	Y85	EGR positioner	3
J404	EWB (close to A80.5)	→	A80	CDI control unit	5.2
	Injectors connector sleeve	→	Y14	Injector 4	2
		→	Y16	Injector 1	2
		→	Y18	Injector 3	2
J405	EWB (close to A80.5)	→	A80	CDI control unit	5.4
	Injectors connector sleeve	→	Y17	Injector 2	2
		→	Y65	Injector 5	2
J406	EWB (close to X195)	→	R41	Crankcase breather heater	
	Exhaust gas recirculation connector sleeve	→	X195	Frame/engine connector	4
		→	Y85	EGR positioner	2
J421	FWH/seat frame (behind rubber grommet)	→	A4	ETC control unit	2.L

	CAN-low connector sleeve	→	A80	CDI control unit	2.12
		→	J378	CAN-low connector sleeve	
J422	FWH/seat frame (behind rubber grommet)	→	A4	ETC control unit	2.H
	CAN-high connector sleeve	→	A80	CDI control unit	2.11
		→	J340	CAN-high connector sleeve	

PE07.16-D-2000-99F

[Display in a separate window](#)

To display wiring diagrams, you need a
JAVA 1.1 capable Browser like e.g. "Microsoft Internet Explorer 4.0"
or
"Netscape Navigator 4.05" and higher with AWT 1.1 support

A12 Electrical center
A80 CDI control module
A80 CDI control module
A80 CDI control module
B108 Camshaft sensor
B110 Engine oil sensor
B113 Rail pressure sensor
B129 Water separator
level sensor
B132 Low pressure
sensor
B16 Coolant temperature
sensor
B30 Fuel temperature
sensor
B73 Crankshaft sensor
J402 Exhaust gas
recirculation
connector sleeve
J403 Exhaust gas
recirculation
connector sleeve
J404 Injectors connector
sleeve
J405 Injectors connector
sleeve
J406 Exhaust gas
recirculation
connector sleeve
R41 Crankcase breather
heater
X195 Frame/engine
connector
Y14 Injector 4
Y16 Injector 1
Y17 Injector 2
Y18 Injector 3
Y65 Injector 5
Y85 Exhaust gas
recirculation
positioner
Y92 Rail pressure control
valve
Y93 High-pressure pump
element shutoff

valve

PE07.16-D-2000-60F	Legend of wiring diagram of common rail diesel injection (CDI)	ENGINE 612.981 in MODEL XD1, XD2, XD3, XD4, XD5, XD6, XD7, YD1, YD2, YD3, YD4, YD5, YD6, YD7, WD1, WD2, WD3, WD6, WD7 ENGINE 612.981 in MODEL 903.61 /66 /67, 904.61 /66 with CODE (ZU7) National version for Canada ENGINE 612.981 in MODEL 903.66 /67, 904.61 /66 with CODE (ZU8) National version for USA ENGINE 612.981 in MODEL 903.61 /62 /66 /67, 904.61 /62 /66 with CODE (ZU9) National version for Mexico engine wiring harness	
--------------------	--	---	--

Code	Designation	Coordinate
A12	Electrical center	18L
A80	CDI control unit	4A 12A 20A
B16	Coolant temperature sensor	1L
B30	Fuel temperature sensor	2L
B73	Crankshaft sensor	7L
B108	Camshaft sensor	4L
B110	Engine oil sensor	13L
B113	Rail pressure sensor	5L
B129	Water separator fill level sensor	12L
B132	Low-pressure sensor	10L
J402	Exhaust gas recirculation connector sleeve	17G
J403	Exhaust gas recirculation connector sleeve	14G
J404	Injectors connector sleeve	21G
J405	Injectors connector sleeve	19G
J406	Exhaust gas recirculation connector sleeve	16G
R41	Crankcase breather heater	16L
X195	Frame/engine connector	16E

Y14	Injector 4	21L
Y16	Injector 1	21L
Y17	Injector 2	19L
Y18	Injector 3	22L
Y65	Injector 5	20L
Y85	EGR positioner	15L
Y92	Rail pressure control valve	8L
Y93	High pressure pump element shutoff valve	9L

PE07.16-D-2000-99G

[Display in a separate window](#)

To display wiring diagrams, you need a
JAVA 1.1 capable Browser like e.g. "Microsoft Internet Explorer 4.0"
or
"Netscape Navigator 4.05" and higher with AWT 1.1 support

A94	CDI control module
A94	CDI control module
A94	CDI control module
A94	CDI control module
B16	Coolant temperature sensor
B30	Fuel temperature sensor
B73	Crankshaft sensor
B101	Air mass meter
B108	Camshaft sensor
B110	Engine oil sensor
B113	Rail pressure sensor
B129	Water separator level sensor
B142	Intake air pressure sensor
J22	Circuit 15, fused, connector sleeve
J406	Exhaust gas recirculation connector sleeve
J406	Exhaust gas recirculation connector sleeve
J476	Exhaust gas recirculation connector sleeve
J476	Exhaust gas recirculation connector sleeve
R25	O2-sensor
R25x1	O2-sensor connector
R41	Crankcase breather heater
X237	Air mass meter connector
Y14	Injector 4
Y16	Injector 1
Y17	Injector 2
Y18	Injector 3
Y65	Injector 5

Y85	Exhaust gas recirculation positioner
Y92	Rail pressure control valve
Y93	Fuel control valve
Y100	Charge pressure positioner

PE07.16-D-2000-60G	Legend of wiring diagram of common rail diesel injection (CDI)	<p>ENGINE 647.981 in MODEL XD1, XD2, XD3, XD4, XD5, XD6, XD7, YD1, YD2, YD3, YD4, YD5, YD6, YD7, WD1, WD2, WD3, WD6, WD7</p> <p>ENGINE 647.981 in MODEL 903.61 /66 /67, 904.61 /66 with CODE (ZU7) National version for Canada</p> <p>ENGINE 647.981 in MODEL 903.61 /66 /67, 904.61 /66 with CODE (ZU8) National version for USA</p> <p>ENGINE 647.981 in MODEL 903.61 /62 /66 /67, 904.61 /62 /66 with CODE (ZU9) National version for Mexico engine wiring harness</p>	
--------------------	--	---	--

Code	Designation	Coordinate
A94	CDI control unit	4A 12A 20A 28A
B16	Coolant temperature sensor	1L
B30	Fuel temperature sensor	2L
B73	Crankshaft sensor	7L
B101	Mass air flow sensor	12L
B108	Camshaft sensor	4L
B110	Engine oil sensor	10L
B113	Rail pressure sensor	5L
B129	Water separator fill level sensor	28L
B142	Intake pressure sensor	14L
J22	Circuit 15 fused connector sleeve	11E
J406	Exhaust gas recirculation connector sleeve	23G 25G
J476	Exhaust gas recirculation connector sleeve	25G 27G
R25	Oxygen sensor	22L
R25x1	Oxygen sensor connector	21J

R41	Crankcase breather heater	15L
X237	Frame/engine connector	11H
Y14	Injector 4	19L
Y16	Injector 1	18L
Y17	Injector 2	16L
Y18	Injector 3	20L
Y65	Injector 5	17L
Y85	EGR positioner	24L
Y92	Rail pressure control valve	8L
Y93	Fuel management valve	9L
Y100	Boost pressure regulator	26L

PE07.16-D-2000-99H

[Display in a separate window](#)

To display wiring diagrams, you need a
JAVA 1.1 capable Browser like e.g. "Microsoft Internet Explorer 4.0"
or
"Netscape Navigator 4.05" and higher with AWT 1.1 support

A10	Airbag control module
A12	Electrical center
A94	CDI control module
A94	CDI control module
A94	CDI control module
A94	CDI control module
A94	CDI control module
B97	Kickdown switch
B141	Charge pressure sensor
B147	Pedal value sensor
D4	Glow time output stage
F140	Fuse box
F140.5	Circuit 30 fuse (125 A)
G2	Battery
G14	Intake air temperature sensor
J18	Circuit 15, fused, connector sleeve
J342	Circuit 30 connector sleeve
J351	Circuit 15 connector sleeve
J352	Circuit 50 connector sleeve
J371	Airbag crash signal connector sleeve
J421	CAN-low connector sleeve
J422	CAN-high connector sleeve
K39	Fuel pump relay module
M18	Fuel pump

P17	Diagnostic socket 16-pin
R13	Glow plug
R14	Glow plug
R15	Glow plug
R16	Glow plug
R17	Glow plug
S123	Switch for cruise control
S123s1	Resume from memory
S123s2	Decelerate/set
S123s3	Accelerate/set
S123s4	Off
S123s5	Control contact
S123x1	Tempomat switch connector
W4	Ground point firewall
W4	Ground point firewall
W5	Ground point seat frame
W7	Ground point (engine compartment)
X4.3	Fuel tank sensor/pump connector

PE07.16-D-2000-60H	Legend of wiring diagram of common rail diesel injection (CDI)	<p>ENGINE 647.981 in MODEL XD1, XD2, XD3, XD4, XD5, XD6, XD7, YD1, YD2, YD3, YD4, YD5, YD6, YD7, WD1, WD2, WD3, WD6, WD7</p> <p>ENGINE 647.981 in MODEL 903.61 /66 /67, 904.61 /66 with CODE (ZU7) National version for Canada</p> <p>ENGINE 647.981 in MODEL 903.61 /66 /67, 904.61 /66 with CODE (ZU8) National version for USA</p> <p>ENGINE 647.981 in MODEL 903.61 /62 /66 /67, 904.61 /62 /66 with CODE (ZU9) National version for Mexico</p> <p>vehicle wiring harness</p>	
--------------------	--	---	--

Code	Designation	Coordinate
A10	Airbag control unit	35L
A12	Electrical center	4L
A94	CDI control unit	4A 12A 20A 28A 34A
B97	Kickdown switch	24L
B141	Boost pressure sensor	15L
B147	Pedal value sensor	12L
D4	Glow time output stage	29L
F140	Fuse box	26G
F140.5	Circuit 30 fuse (125 A)	26F
G2	Battery	26L
G14	Charge air temperature sensor	11L
J18	Circuit 15 fused connector sleeve	28E
J342	Circuit 30 connector sleeve	2E
J351	Circuit 15 connector sleeve	7G
J352	Circuit 50 connector sleeve	4E
J371	Airbag crash signal connector sleeve	34E

J421	CAN-low connector sleeve	22E
J422	CAN-high connector sleeve	22E
K39	Fuel pump relay module	7L
M18	Fuel pump (FP)	9L
P17	Diagnostic socket 16-pin	26E
R13	Glow plug	28G
R14	Glow plug	28G
R15	Glow plug	29G
R16	Glow plug	29G
R17	Glow plug	30G
S123	cruise control switch	33L
S123s1	Resume from memory	33J
S123s2	Decelerate/set	33K
S123s3	Accelerate/set	33K
S123s4	Off	33K
S123s5	Control contact	33L
S123x1	Tempomat switch connector	31H
W4	Firewall ground point	1E 25G
W5	Seat frame ground point	9E
W7	Engine compartment ground point	30G
X4.3	Fuel level sensor/pump connector	9H

PE83.10-D-2100-99B

[Display in a separate window](#)

To display wiring diagrams, you need a
JAVA 1.1 capable Browser like e.g. "Microsoft Internet Explorer 4.0"
or
"Netscape Navigator 4.05" and higher with AWT 1.1 support

- F150 Roof fan fuse (15 A)
- J31 Circuit 15, fused, connector sleeve
- J417 Circuit 15, fused, connector sleeve
- J46 Circuit 58 connector sleeve
- M59 Roof fan motor
- S90 Roof fan switch
- W8 Ground point waistrail
- W8 Ground point waistrail
- X231 Roof fan motor plug connection
- X81 Frame/waistrail plug connection

PE83.10-D-2100-60B	Legend of wiring diagram roof fan	<p>Models YD1, YD2, YD3, YD4, YD5, YD6, YD7, WD1, WD2, WD3, WD6, WD7</p> <p>Models 903.61 /66 /67, 904.61 /66</p> <p>with CODE (H72) Electric roof ventilator</p> <p>with CODE (ZU7) Canada national version</p> <p>Models 903.61 /66 /67, 904.61 /66</p> <p>with CODE (H72) Electric roof ventilator</p> <p>with CODE (ZU8) USA national version</p> <p>Models 903.61 /66 /67, 904.61 /66</p> <p>with CODE (H72) Electric roof ventilator</p> <p>with CODE (ZU9) Mexico national version</p>	
--------------------	-----------------------------------	---	--

Code	Designation	Coordinate
F150	Roof fan fuse (15 A)	3C
J31	Circuit 15 fused connector sleeve	4A
J46	Circuit 58 connector sleeve	1G
J417	Circuit 15 fused connector sleeve	3G
M59	Roof fan motor	6A
S90	Roof fan switch	4L
W8	Ground point waistrail	2G 5G
X81	Frame/waistrail connector	3F
X231	Roof fan motor plug connection	5H

GF00.19-D-3100-67A	Arrangement and assignment of terminal block connectors roof fan	<p>Models YD1, YD2, YD3, YD4, YD5, YD6, YD7, WD1, WD2, WD3, WD6, WD7</p> <p>Models 903.61/66/67, 904.61/66 with code (H72) Electric roof ventilator with code (ZU7) National version for Canada</p> <p>Models 903.61/66/67, 904.61/66 with code (H72) Electric roof ventilator with code (ZU8) National version for USA</p> <p>Models 903.61/66/67, 904.61/66 with code (H72) Electric roof ventilator with code (ZU9) National version for Mexico</p>	
--------------------	--	--	--

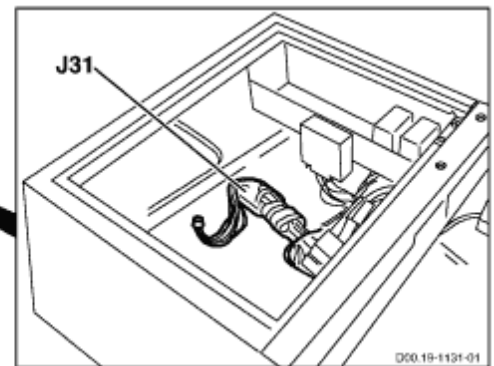
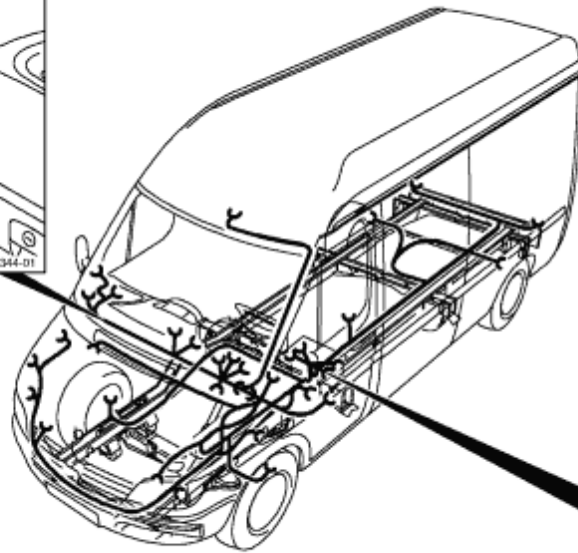
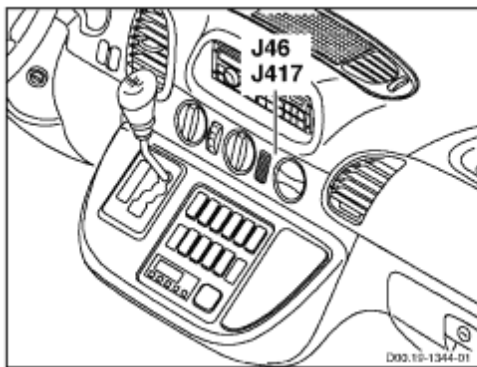

D00.19-1383-09

Terminal block	Designation		Component	Designation	Connector Pin
J31	FWH/seat frame (behind rubber	→	F5	ABS terminal 15 fuse	1

	grommet)				
	Circuit 15 fused connector sleeve	→	F52	Front passenger door power window fuse (25 A)	1
		→	F53	Driver door power window fuse (25 A)	1
		→	F54	Heated and adjustable exterior mirror fuse (10 A)	1
		→	F86	EDW circuit 15 fuse (7.5 A)	1
		→	F127	Differential lock fuse (15 A)	1
		→	F128	Driver, passenger seat heater fuse (15 A)	1
		→	F139	Additional heater fuse (10 A)	1
		→	F150	Roof fan fuse (15 A)	1
		→	K70	Circuit 15 relay for optional equipment	1
J46	WWH (middle of instrument panel)	→	A9	Radio	1.A6
	Circuit 58 connector sleeve	→	A40	EWM control unit	2
		→	A71	Heater timer	1
		→	A81	Air conditioning pushbutton control and operating unit	1.9
		→	E104	Ashtray lighting	1
		→	S12	Driver seat heater switch	1
		→	S25	Headlamp range adjustment switch	9
		→	S48	ASR switch	1
		→	S57	Differential lock switch	1
		→	S81	Rear window defroster pushbutton	1
		→	S85	Driver interior lighting pushbutton	1
		→	S87	Auxiliary heater switch	1
		→	S90	Roof fan switch	1
		→	S92	Panic alarm button	1
		→	S99	ATA [EDW] towing/interior motion sensor button	1
		→	S100	Additional heat exchanger double-contact pushbutton	1
		→	S107	Front passenger seat heater switch	1
		→	S119.1	Fog light switch	1

		→	S124	Reading lamp switch	1
		→	S126	Interior pushbutton	1
		→	S137	Roof AC switch	1
		→	S138	Temperature switch	9
		→	X79	Frame/waistrail connector	2
		→	X234	Cigar lighter illumination plug connection	3
J417	WWH (middle of instrument panel)	→	S90	Roof fan switch	3 8
	Circuit 15 fused connector sleeve	→	X81	Frame/waistrail connector	15

PE35.40-D-2000-99D

[Display in a separate window](#)

To display wiring diagrams, you need a
JAVA 1.1 capable Browser like e.g. "Microsoft Internet Explorer 4.0"
or
"Netscape Navigator 4.05" and higher with AWT 1.1 support

- J142 Circuit 15, fused, connector sleeve
- J31 Circuit 15, fused, connector sleeve
- J46 Circuit 58 connector sleeve
- S104 Differential lock switch
- S57 Differential lock switch
- W7 Ground point (engine compartment)
- W8 Ground point waistrail
- X80 Frame/waistrail plug connection
- Y8 Differential lock solenoid valve

PE35.40-D-2000-60D	Legend of wiring diagram for rear axle differential lock operating mechanism	REAR AXLE 741 in MODEL XD1, XD2, XD3, XD4, XD5, XD6, XD7, YD1, YD2, YD3, YD4, YD5, YD6, YD7, WD1, WD2, WD3, WD6, WD7 REAR AXLE 741 in MODELS 903.61 /66 /67, 904.61 /66 with CODE (A71) Rear axle differential lock with CODE (ZU7) national version for Canada REAR AXLE 741 in MODELS 903.61 /66 /67, 904.61 /66 with CODE (A71) Rear axle differential lock with CODE (ZU8) national version for USA	
--------------------	--	---	--

Code	Designation	Coordinate
F127	Differential lock fuse (15 A)	2D
J31	Circuit 15 fused connector sleeve	2A
J46	Circuit 58 connector sleeve	5G
J142	Circuit 15 fused connector sleeve	3D
S57	Differential lock switch	4L
S104	Differential lock switch	4A
W7	Engine compartment ground point	1D
W8	Ground point waistrail	6G
X80	Frame/waistrail connector	1G
Y8	Differential lock solenoid valve	1A

GF00.19-D-3100-20C	Arrangement and assignment of terminal block connectors rear axle differential lock	<p>Rear axle 741 in models XD1, XD2, XD3, XD4, XD5, XD6, XD7, YD1, YD2, YD3, YD4, YD5, YD6, YD7, WD1, WD2, WD3, WD6, WD7</p> <p>Rear axle 741 in models 903.61/66/67, 904.61/66 with code (A71) rear axle differential lock with code (ZU7) National version for Canada</p> <p>Rear axle 741 in models 903.61/66/67, 904.61/66 with code (A71) rear axle differential lock with code (ZU8) National version for USA</p>	
--------------------	---	---	--

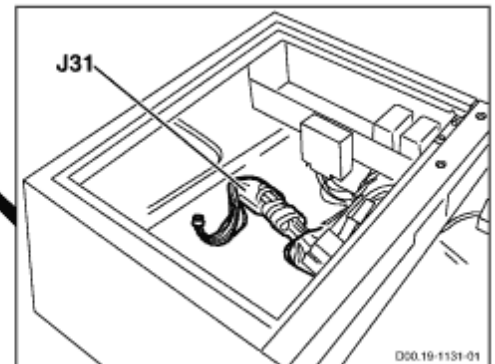
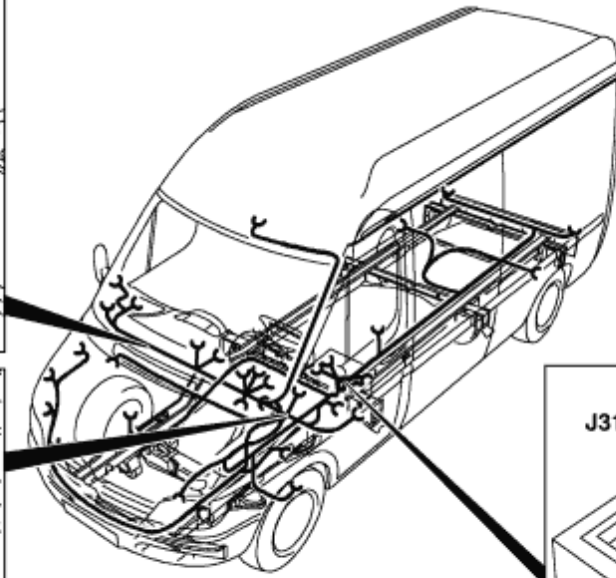
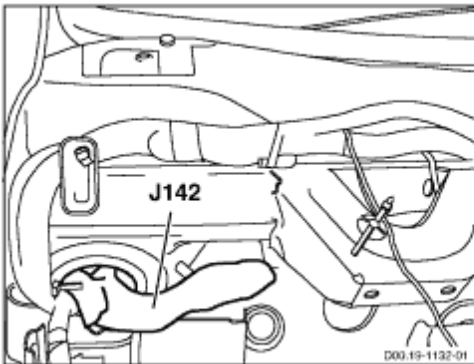
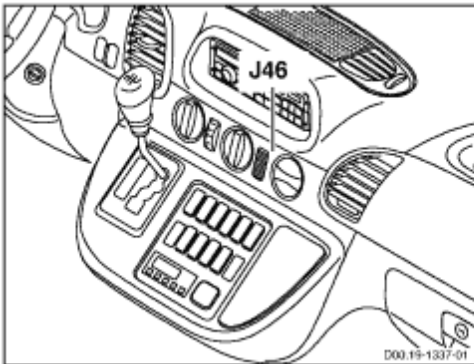

D00.19-1359-09

Terminal block	Designation		Component	Designation	Connector Pin
J31	FWH/seat frame (behind rubber grommet)	→	F5	ABS terminal 15 fuse	1
	Circuit 15 fused connector sleeve	→	F52	Front passenger door power window fuse (25 A)	1

		→	F53	Driver door power window fuse (25 A)	1
		→	F54	Heated and adjustable exterior mirror fuse (10 A)	1
		→	F86	EDW circuit 15 fuse (7.5 A)	1
		→	F127	Differential lock fuse (15 A)	1
		→	F128	Driver, passenger seat heater fuse (15 A)	1
		→	F139	Additional heater fuse (10 A)	1
		→	F150	Roof fan fuse (15 A)	1
		→	K70	Circuit 15 relay for optional equipment	1
J46	WWH (middle of instrument panel)	→	A9	Radio	1.A6
	Circuit 58 connector sleeve	→	A40	EWM control unit	2
		→	A71	Heater timer	1
		→	A81	Air conditioning pushbutton control and operating unit	1.9
		→	E104	Ashtray lighting	1
		→	S12	Driver seat heater switch	1
		→	S25	Headlamp range adjustment switch	9
		→	S48	ASR switch	1
		→	S57	Differential lock switch	1
		→	S81	Rear window defroster pushbutton	1
		→	S85	Driver interior lighting pushbutton	1
		→	S87	Auxiliary heater switch	1
		→	S90	Roof fan switch	1
		→	S92	Panic alarm button	1
		→	S99	ATA [EDW] towing/interior motion sensor button	1
		→	S100	Additional heat exchanger double-contact pushbutton	1
		→	S107	Front passenger seat heater switch	1
		→	S119.1	Fog light switch	1
		→	S124	Reading lamp switch	1
		→	S126	Interior pushbutton	1
		→	S137	Roof AC switch	1

		→	S138	Temperature switch	9
		→	X79	Frame/waistrail connector	2
		→	X234	Cigar lighter illumination plug connection	3
J142	FWH/waistrail (next to firewall rubber grommet)	→	F127	Differential lock fuse (15 A)	2
	Circuit 15 fused connector sleeve	→	S104	Differential lock switch	2
		→	X80	Frame/waistrail connector	12

PE82.20-D-2100-99C

[Display in a separate window](#)

To display wiring diagrams, you need a
JAVA 1.1 capable Browser like e.g. "Microsoft Internet Explorer 4.0"
or
"Netscape Navigator 4.05" and higher with AWT 1.1 support

A12	Electrical center
A12f8	Interior lights, radio circuit 30 fuse
E31	Driver entry light
E32	Front passenger entry light
E98	Right sliding door entry light
E99	Left sliding door entry light
J3	Interior lamp connector sleeve
J6	Circuit 30, fused, connector sleeve
J77	Interior lamp connector sleeve
J78	Interior lamp connector sleeve
S114	Left sliding door contact switch
S115	Right sliding door contact switch
S116	Tailgate contact switch
S42	Left door contact switch
S43	Right door contact switch
X45	Frame/roof connector (standard)

PE82.20-D-2100-60C	Legend for wiring diagram of entrance/exit lamps	<p>Model XD1, XD2, XD3, XD4, XD5, XD6, XD7, YD1, YD2, YD3, YD4, YD5, YD6, YD7, WD1, WD2, WD3, WD6, WD7</p> <p>Models 903.61 /66 /67, 904.61 /66 with CODE (LB9) illuminated exit with CODE (ZU7) Canada national version</p> <p>Models 903.61 /66 /67, 904.61 /66 with CODE (LB9) illuminated exit with CODE (ZU8) USA national version</p>	
--------------------	--	---	--

Code	Designation	Coordinate
A12	Electrical center	2A
A12f8	Interior lights, radio circuit 30 fuse	2B
E31	Driver entry lamp	6A
E32	Front passenger entry lamp	4A
E98	Right sliding door entry lamp	3L
E99	Left sliding door entry lamp	4L
J3	Interior light connector sleeve	10H
J6	Circuit 30 fused connector sleeve	1E
J77	Interior light connector sleeve	5H
J78	Interior light connector sleeve	4H
S42	Left door contact switch	10L
S43	Right door contact switch	11L
S114	Left sliding door contact switch	6L
S115	Right sliding door contact switch	7L
S116	Rear door contact switch	8L
X45	Frame/roof connector (standard)	1H

GF00.19-D-3100-53C

Arrangement and assignment of terminal block connectors entry/exit lamps

Models XD1, XD2, XD3, XD4, XD5, XD6, XD7, YD1, YD2, YD3, YD4, YD5, YD6, YD7, WD1, WD2, WD3, WD6, WD7
Models 903.61/66/67, 904.61/66
with code (LB9) Illuminated exit
with code (ZU7) National version for Canada
Models 903.61/66/67, 904.61/66
with code (LB9) Illuminated exit
with code (ZU8) National version for USA

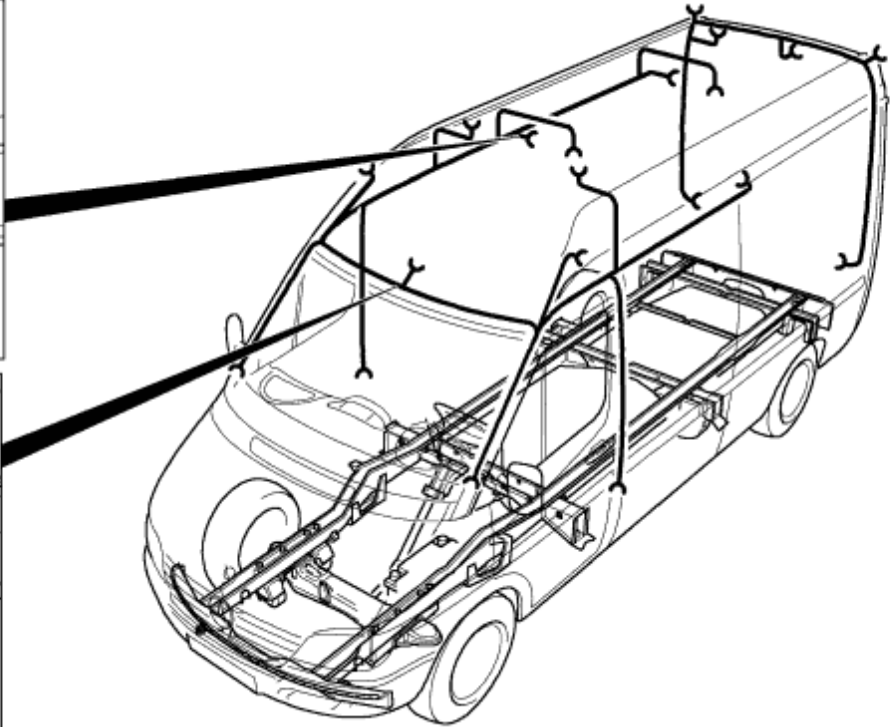
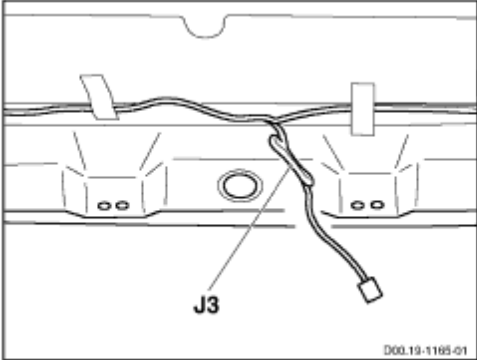
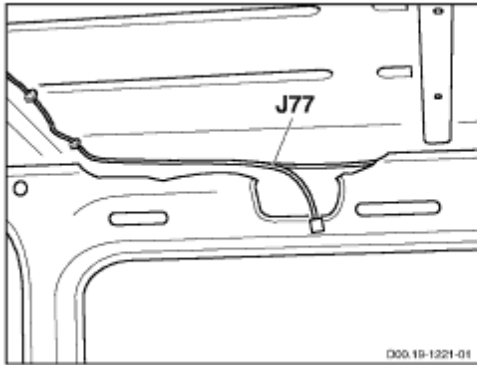

D00.19-1288-09

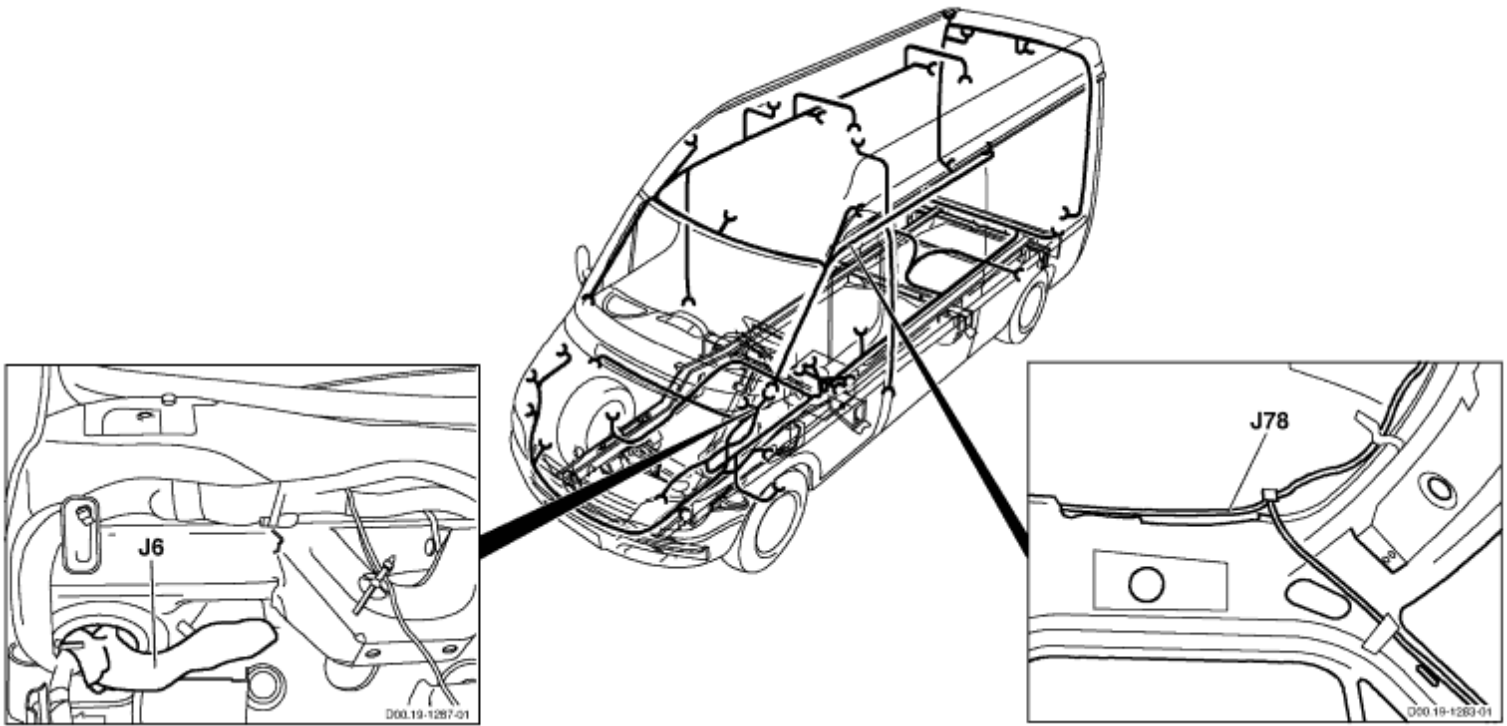

D00.19-1289-09

Terminal block	Designation		Component	Designation	Connector Pin
J3	RWH (close to E43)	→	E31	Driver entry lamp	2
	Interior light connector sleeve	→	E32	Front passenger entry lamp	2
		→	E43	Cab lamp	3
		→	S42	Left door contact switch	
		→	S43	Right door contact switch	
		→	X45	Frame/roof connector (standard)	5
		→	X193	Frame/roof connector	2
J6	FWH/waistrail (next to firewall rubber grommet)	→	A12	Electrical center	4.11
	Circuit 30 fused connector sleeve	→	K101	Left EDW turn signal lamp relay	5
		→	K102	Right EDW turn signal lamp relay	5
		→	X45	Frame/roof connector (standard)	1
		→	X79	Frame/waistrail connector	8
J77	RWH (close to interior light E70)	→	E69	Left side interior lamp	3
	Interior light connector sleeve	→	E70	Right side interior lamp	3
		→	E71	Rear interior lamp	3

		→	E73	Middle interior lamp, rear	3
		→	E74	Middle interior lamp, front	3
		→	E89	Rear interior lamp	2
		→	E98	Right sliding door entry lamp	2
		→	E99	Left sliding door entry lamp	2
		→	S114	Left sliding door contact switch	
		→	S115	Right sliding door contact switch	
		→	S116	Rear door contact switch	
		→	X193	Frame/roof connector	1
J78	RWH (close to left front body-outline light)	→	E31	Driver entry light	1
	Interior light connector sleeve	→	E32	Front passenger entry lamp	1
		→	E43	Cab lamp	2
		→	E69	Left side interior lamp	2
		→	E70	Right side interior lamp	2
		→	E71	Rear interior lamp	2
		→	E73	Middle interior lamp, rear	2
		→	E74	Middle interior lamp, front	2
		→	E89	Rear interior lamp	1
		→	E98	Right sliding door entry lamp	1
		→	E99	Left sliding door entry lamp	1
		→	X45	Frame/roof connector (standard)	1

PE80.50-D-2000-99D

[Display in a separate window](#)

To display wiring diagrams, you need a
JAVA 1.1 capable Browser like e.g. "Microsoft Internet Explorer 4.0"
or
"Netscape Navigator 4.05" and higher with AWT 1.1 support

A8	Central locking control module
A12	Electrical center
A62	WSP control module
A82	ATA 2 control module
A82	ATA 2 control module
A82	ATA 2 control module
A82	ATA 2 control module
A82	ATA 2 control module
A82	ATA 2 control module
A82	ATA 2 control module
B104	Interior sensor
B105	Interior sensor
B106	Interior sensor
E60	Right rear window defroster
E61	Left rear window defroster
F86	ATA circuit 15 fuse (7.5 A)
F112	ATA 2 horn, interior circuit fuse (7.5 A)
F120	ATA 2 turn signals fuse (15 A)
H78	Battery-operated horn
J3	Interior light connector sleeve
J31	Terminal 15 connector sleeve, fused
J46	Terminal 58 connector sleeve
J46	Terminal 58 connector sleeve
J77	Interior light connector sleeve
J80	Right turn signal lamp connector

	sleeve
J81	Left turn signal lamp connector sleeve
J312	Circuit 30 connector sleeve
J333	Circuit 30 connector sleeve
J334	ATA interior motion sensor connector sleeve
J334	ATA interior motion sensor connector sleeve
J335	ATA interior motion sensor connector sleeve
J336	Circuit 30, fused, connector sleeve
J336	Circuit 30, fused, connector sleeve
J337	ATA 2 blower stage connector sleeve
J358	Tml. 31 connector sleeve
J375	Diagnostic line connector sleeve
J386	Right rear window defroster connector sleeve, ATA 2
J387	Left rear window defroster connector sleeve, ATA 2
P17	Diagnostic socket, 16-pin
S18	ATA contact switch (hood)
S45	Driver door lock switch
S45x1	Driver door lock switch connector
S92	ATA 2 panic alarm pushbutton
S99	Towing/interior motion sensor ATA 2 pushbutton

W2.1	Ground point ATA, right headlamp
W4	Ground point firewall
W4	Ground point firewall
W4	Ground point firewall
W5	Ground point seat frame
W6	Ground point taillamp
W6	Ground point taillamp
W8	Ground point (waistrail)
W8	Ground point (waistrail)
X29	Left rear contact plate, 3-pin
X32	Right rear rear window defroster contact plate, 2-pin
X34	Right rear contact plate, 3-pin
X45	Frame/roof connector (standard)
X142	Frame/waistrail connector
X142	Frame/waistrail connector
X193	Frame/roof connector
X194	ATA 2 connector
X194	ATA 2 connector
X194	ATA 2 connector
X218	ATA 2 connector



PE80.50-D-2000-60D	Legend for wiring diagram of anti-theft alarm system (ATA)	<p>MODEL XD1, XD2, XD3, XD4, XD5, XD6, XD7, YD1, YD2, YD3, YD4, YD5, YD6, YD7, WD1, WD2, WD3, WD6, WD7</p> <p>MODEL 903.61 /66 /67, 904.61 /66</p> <p>with CODE (FY1) Nnti-theft alarm with interior protection system, towing sensor and battery-operated horn with CODE (ZU7) National version for Canada</p> <p>MODEL 903.61 /66 /67, 904.61 /66</p> <p>with CODE (FY1) Anti-theft alarm with interior protection system, towing sensor and battery-operated horn with CODE (ZU8) National version for USA</p>	
--------------------	--	---	--

Code	Designation	Coordinate
A8	Central locking control unit	43L
A12	Electrical center	9L
A62	WSP control unit	45L
A82	ATA control unit	4A 12A 20A 28A 36A 44A
B104	Interior sensor	24L
B105	Interior sensor	28L
B106	Interior sensor	30L
E60	Right rear window defroster	40L
E61	Left rear window defroster	37L
F86	ATA circuit 15 fuse (7.5 A)	4E
F112	ATA [ATA] fuse (7.5 A), interior circuit	7G
F120	ATA [ATA] turn signal indicator (15 A)	7E
H78	Battery-operated horn	34L
J3	Interior light connector sleeve	21H

J31	Circuit 15 fused connector sleeve	4H
J46	Circuit 58 connector sleeve	3G 15E
J77	Interior light connector sleeve	21H
J80	Right turn signal light connector sleeve	6H
J81	Left turn signal light connector sleeve	5H
J312	Circuit 30 connector sleeve	9G
J333	Circuit 30 connector sleeve	8G
J334	ATA [ATA] interior sensor connector sleeve	29G 31G
J335	ATA [ATA] interior sensor connector sleeve	24G
J336	Circuit 30 fused connector sleeve	7E 33E
J337	ATA 2 blower stage connector sleeve	2E
J358	Tml. 31 connector sleeve	27G
J375	Diagnostic cable connector sleeve	35G
J386	Right heated rear window connector sleeve, ATA [ATA]	40E
J387	Left heated rear window connector sleeve, ATA [ATA]	37E
P17	Diagnostic socket 16-pin	36L
S18	ATA (hood) contact switch	14L
S45	Driver door lock switch	12L
S45X1	Driver door lock switch connector	11J
S92	Panic alarm button	2L
S99	ATA [ATA] towing/interior motion sensor button	17L
W2.1	Ground point ATA, right headlamp	15G
W4	Firewall ground point	13E 26L 34H
W5	Seat frame ground point	3E
W6	Ground point taillamp	38E 41E
W8	Ground point waistrail	3G 19G
X29	Left rear contact plate 3-pin	36H
X32	Rear window defroster right rear contact plate 2-pin	39G
X34	Right rear contact plate 3-pin	41G

X45	Frame/roof connector (standard)	26J
X142	Frame/waistrail connector	1H 16E
X193	Frame/roof connector	20E
X194	ATA [ATA] connector	11E 33H 44H
X218	ATA [ATA] connector	9E

GF00.19-D-3100-33C

Arrangement and assignment of terminal block connectors anti-theft alarm (ATA)

Models XD1, XD2, XD3, XD4, XD5, XD6, XD7, YD1, YD2, YD3, YD4, YD5, YD6, YD7, WD1, WD2, WD3, WD6, WD7
Models 903.61/66/67, 904.61/66
with code (FY1) Anti-theft alarm system with interior motion sensor, towing sensor and rechargeable horn
with code (ZU7) National version for Canada
Models 903.61/66/67, 904.61/66
with code (FY1) Anti-theft alarm system with interior motion sensor, towing sensor and rechargeable horn
with code (ZU8) National version for USA

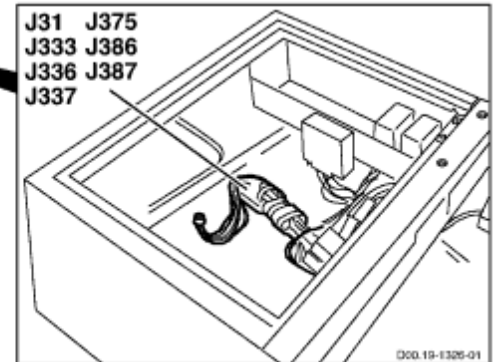
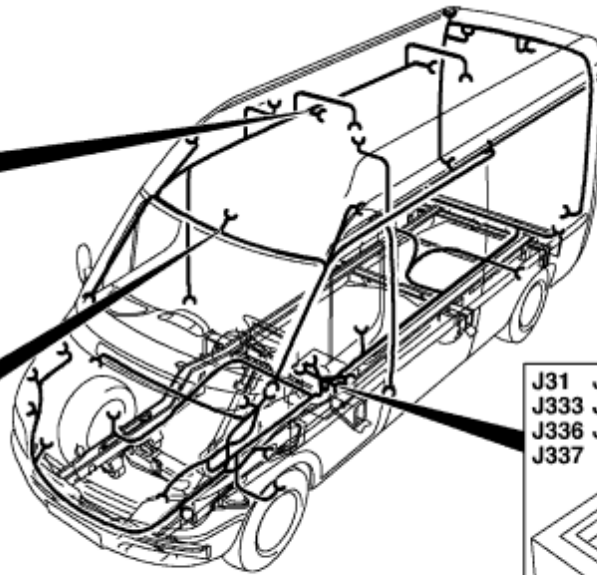
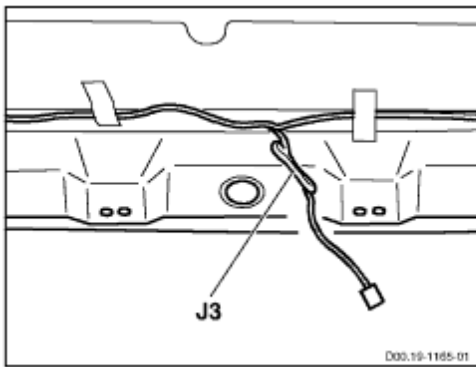
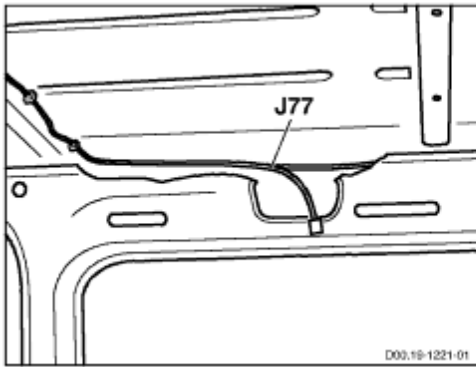

D00.19-1370-09

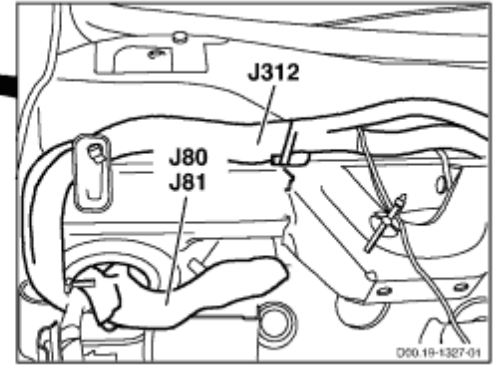
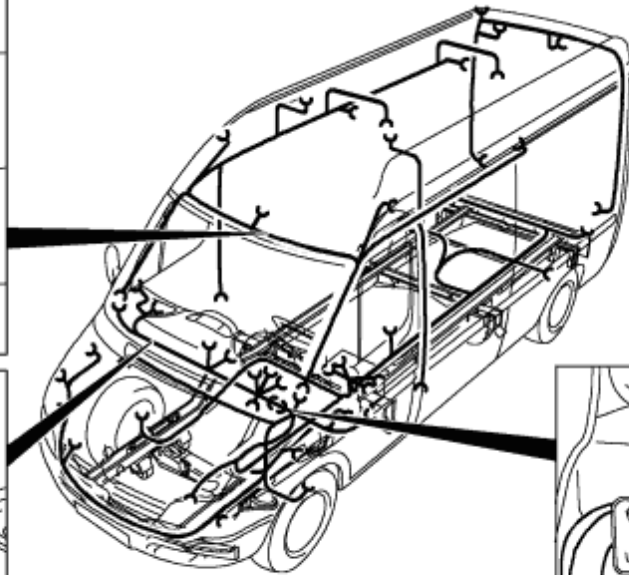
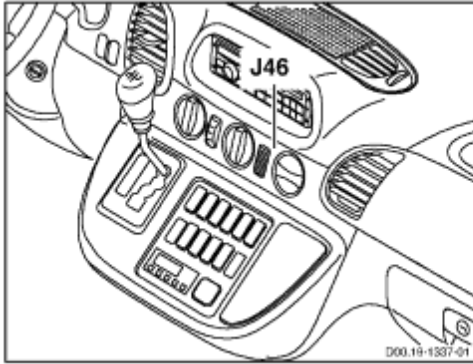
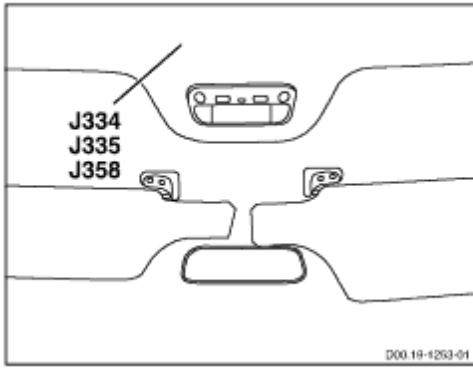

D00.19-1371-09

Terminal block	Designation		Component	Designation	Connector Pin
J3	RWH (close to E43)	→	E31	Driver entry lamp	2
	Interior light connector sleeve	→	E32	Front passenger entry lamp	2
		→	E43	Cab lamp	3
		→	S42	Left door contact switch	
		→	S43	Right door contact switch	
		→	X45	Frame/roof connector (standard)	5
		→	X193	Frame/roof connector	2
J31	FWH/seat frame (behind rubber grommet)	→	F5	ABS terminal 15 fuse	1
	Circuit 15 fused connector sleeve	→	F52	Front passenger door power window fuse (25 A)	1
		→	F53	Driver door power window fuse (25 A)	1
		→	F54	Heated and adjustable exterior mirror fuse (10 A)	1
		→	F86	EDW circuit 15 fuse (7.5 A)	1
		→	F127	Differential lock fuse (15 A)	1

		→	F128	Driver, passenger seat heater fuse (15 A)	1
		→	F139	Additional heater fuse (10 A)	1
		→	F150	Roof fan fuse (15 A)	1
		→	K70	Circuit 15 relay for optional equipment	1
J46	WWH (middle of instrument panel)	→	A9	Radio	1.A6
	Circuit 58 connector sleeve	→	A40	EWM control unit	2
		→	A71	Heater timer	1
		→	A81	Air conditioning pushbutton control and operating unit	1.9
		→	E104	Ashtray lighting	1
		→	S12	Driver seat heater switch	1
		→	S25	Headlamp range adjustment switch	9
		→	S48	ASR switch	1
		→	S57	Differential lock switch	1
		→	S81	Rear window defroster pushbutton	1
		→	S85	Driver interior lighting pushbutton	1
		→	S87	Auxiliary heater switch	1
		→	S90	Roof fan switch	1
		→	S92	Panic alarm button	1
		→	S99	ATA [EDW] towing/interior motion sensor button	1
		→	S100	Additional heat exchanger double-contact pushbutton	1
		→	S107	Front passenger seat heater switch	1
		→	S119.1	Fog light switch	1
		→	S124	Reading lamp switch	1
		→	S126	Interior pushbutton	1
		→	S137	Roof AC switch	1
		→	S138	Temperature switch	9
		→	X79	Frame/waistrail connector	2
		→	X234	Cigar lighter illumination plug connection	3
J77	RWH (close to interior light E70)	→	E69	Left side interior lamp	3
	Interior light connector sleeve	→	E70	Right side interior lamp	3

		→	E71	Rear interior lamp	3
		→	E73	Middle interior lamp, rear	3
		→	E74	Middle interior lamp, front	3
		→	E89	Rear interior lamp	2
		→	E98	Right sliding door entry lamp	2
		→	E99	Left sliding door entry lamp	2
		→	S114	Left sliding door contact switch	
		→	S115	Right sliding door contact switch	
		→	S116	Rear door contact switch	
		→	X193	Frame/roof connector	1
J80	FWH/waistrail (next to firewall rubber grommet)	→	A12	Electrical center	5.5
	Right turn signal light connector sleeve	→	A82	EDW control unit	1.4
		→	A93	Trailer socket control unit	2.B
		→	E26H3	Right front turn signal lamp	6
		→	E68h4	Right rear turn signal lamp	5
		→	H2	Right front side turn signal lamp (5 W)	1
		→	H9	Right front side turn signal lamp (21 W)	1
		→	K102	Right EDW turn signal lamp relay	1
		→	P15	Instrument cluster	1.7
J81	FWH/waistrail (next to firewall rubber grommet)	→	A12	Electrical center	5.8
	Left turn signal light connector sleeve	→	A62	WSP control unit	8
		→	A82	EDW control unit	1.1
		→	A93	Trailer socket control unit	2.E
		→	E25h21	Left front turn signal lamp	6
		→	E67h22	Left rear turn signal lamp	5
		→	H5	Left front side turn signal lamp (5 W)	1
		→	H10	Left front side turn signal lamp (21 W)	1
		→	K101	Left EDW turn signal lamp relay	1
		→	P15	Instrument cluster	2.13

J312	FWH/waistrail (behind instrument cluster)	→	A12	Electrical center	8
	Circuit 30 connector sleeve	→	F140.6	Circuit 30 fuse (100 A)	
		→	X218	ATA [EDW] connector	1
J333	FWH/seat frame (behind rubber grommet)	→	F112	ATA [EDW] fuse (7.5 A), interior circuit	1
	Circuit 30 connector sleeve	→	F120	ATA [EDW] turn signal indicator (15 A)	1
		→	X218	ATA [EDW] connector	1
J334	RHW (close to interior motion sensor B104)	→	B104	Interior sensor	4
	ATA [EDW] interior sensor connector sleeve	→	B105	Interior sensor	4
		→	B106	Interior sensor	4
		→	X193	Frame/roof connector	3
J335	RHW (close to interior motion sensor B104)	→	B104	Interior sensor	3
	ATA [EDW] interior sensor connector sleeve	→	B105	Interior sensor	3
		→	B106	Interior sensor	3
		→	X193	Frame/roof connector	4
J336	FWH/seat frame (behind rubber grommet)	→	A82	EDW control unit	1.13
	Circuit 30 fused connector sleeve	→	F112	ATA [EDW] fuse (7.5 A), interior circuit	2
		→	X193	Frame/roof connector	3
		→	X194	ATA [EDW] connector	2
J337	FWH/seat frame (behind rubber grommet)	→	A82	EDW control unit	1.5
	ATA [EDW] blower stage connector sleeve	→	K75	Warm water auxiliary heater fan stage 1 relay	5
	block diagram,	→	X82	Frame/waistrail connector	14
		→	X194	ATA [EDW] connector	8
J358	RHW (close to interior motion sensor B104)	→	B104	Interior sensor	1
	Tml. 31 connector sleeve	→	B105	Interior sensor	1
		→	B106	Interior sensor	1
		→	E12	Additional stop light	2

		→	E38	Left front body outline lamp	2
		→	E39	Right front body outline lamp	2
		→	E43	Cab lamp	1
		→	E53	Interior light I	2
		→	E54	Interior light II	2
		→	E55	Interior light III	2
		→	E102	Interior lamp IV	2
		→	E103	Interior lamp V	2
		→	E69	Left side interior lamp	1
		→	E70	Right side interior lamp	1
		→	E73	Middle interior lamp, rear	1
		→	E74	Middle interior lamp, front	1
		→	J147	Turn signal ground connector sleeve	
		→	X45	Frame/roof connector (standard)	6
		→	X161	Reading lamp plug connection	1
		→	X171	Interior lighting connector	3
J375	FWH/seat frame (behind rubber grommet)	→	A8	Central locking control unit	1.12
	Diagnostic cable connector sleeve	→	A82	EDW control unit	2.8
		→	P17	Diagnostic socket 16-pin	12
		→	X5.1	Additional heater connector LHS	3
J386	FWH/seat frame (behind rubber grommet)	→	A82	EDW control unit	2.3
	Right rear window defroster connector sleeve, ATA	→	K86	Right rear window defroster relay, ATA	1
		→	X32	Rear window defroster right rear contact plate 2-pin	1
		→	X34	Right rear contact plate 3-pin	3
J387	FWH/seat frame (behind rubber grommet)	→	A82	EDW control unit	2.2
	Left rear window defroster connector sleeve, ATA	→	K87	Left rear window defroster relay, ATA	1
		→	X29	Left rear contact plate 3-pin	1

PE27.19-D-2100-99A

[Display in a separate window](#)

To display wiring diagrams, you need a
JAVA 1.1 capable Browser like e.g. "Microsoft Internet Explorer 4.0"
or
"Netscape Navigator 4.05" and higher with AWT 1.1 support

A2	ABS control module
A4	ETC control module
A4	ETC control module
A4	ETC control module
A4	ETC control module
A4	ETC control module
A12	Electrical center
A12	Electrical center
A12f4	Backup lamp fuse
A12f7	Horn, rear window defroster, circuit 15 relay fuse
A40	Electronic selector lever module control module
B127	Stop lamp switch, 6-pin
F138	Circuit 15 fuse (10 A)
J8	Stop lamp connector sleeve
J16	Circuit 30 connector sleeve
J20	Reversing lamp connector sleeve
J22	Circuit 15, fused, connector sleeve
J46	Terminal 58 connector sleeve
J277	Terminal 15 connector sleeve
J401	Diagnostic line connector sleeve
J421	CAN-low connector sleeve
J422	CAN-high connector sleeve
J423	Circuit 87

	connector sleeve
J424	Diagnostic line connector sleeve
K138	Circuit 15 relay
P17	Diagnostic socket 16-pin
W5	Ground point seat frame
W8	Ground point (wastrail)
X106	ETC control unit
X106	ETC control unit
X106b1	1-2 and 4-5 shift solenoid valve
X106b2	2-3 shift solenoid valve
X106b3	3-4 shift solenoid valve
X106b4	Torque converter lockup solenoid valve
X106b5	RPM sensor 3
X106b6	Temperature sensor/starter lockout contact
X106b7	RPM sensor 2
X106b8	Modulating pressure solenoid valve
X106b9	Shift pressure solenoid valve
X106x1	ETC plug connection
X217	Frame/dash support connector

PE27.19-D-2100-60A	Legend of wiring diagram of electronic transmission control (ETC)	<p>TRANSMISSION 722.681 in MODEL XD1, XD2, XD3, XD4, XD5, XD6, XD7, YD1, YD2, YD3, YD4, YD5, YD6, YD7, WD1, WD2, WD3, WD6, WD7</p> <p>TRANSMISSION 722.681 in MODELS 903.61 /66 /67, 904.61 /66 with CODE (G40) Automatic transmission with CODE (ZU7) National version for Canada</p> <p>TRANSMISSION 722.681 in MODELS 903.61 /66 /67, 904.61 /66 with CODE (G40) Automatic transmission with CODE (ZU8) National version for USA</p> <p>TRANSMISSION 722.681 in MODELS 903.61 /62 /66 /67, 904.61 /62 /66 with CODE (G40) Automatic transmission with CODE (ZU9) National version for Mexiko</p>	
--------------------	---	---	--

Code	Designation	Coordinate
A2	ABS/ESP control unit	23L
A4	ETC control unit	4A 12A 20A 28A 36A
A12	Electrical center	8L 20L
A12f4	Reversing lamp fuse	7K
A12f7	Horn, rear window defroster, circuit 15 relay fuse	6K
A40	EWM control unit	12L
B127	Stop light switch 6-pin	17L
F138	Circuit 15 fuse (10 A)	2G
J8	Stop light connector sleeve	17G
J16	Circuit 30 connector sleeve	3E

J20	Reversing lamp connector sleeve	13E
J22	Circuit 15 fused connector sleeve	4G
J46	Circuit 58 connector sleeve	10G
J277	Circuit 15 connector sleeve	18G
J401	Diagnostic cable connector sleeve	12E
J421	CAN-low connector sleeve	25E
J422	CAN-high connector sleeve	25E
J423	Circuit 87 connector sleeve	5E
J424	Diagnostic cable connector sleeve	1E
K138	Circuit 15 relay	4L
P17	Diagnostic socket 16-pin	1G
W5	Seat frame ground point	3E
W8	Ground point waistrail	10G
X106	EGS control unit	28L 36L
X106b1	1-2 and 4-5 shift solenoid valve	27K
X106b2	2-3 shift solenoid valve	28K
X106b3	3-4 shift solenoid valve	29K
X106b4	Torque converter lockup solenoid valve	30K
X106b5	RPM sensor 3	35K
X106b6	Temperature sensor/starter lockout contact	37K
X106b7	RPM sensor 2	34K
X106b8	Modulating pressure solenoid valve	32K
X106b9	Shift pressure solenoid valve	32K
X106x1	ETC plug connection	26F
X217	Frame/waistrail connector	11G

GF00.19-D-3100-66A

Arrangement and assignment of terminal blocks of electronic transmission control (ETC)

Transmission 722.681 in models XD1, XD2, XD3, XD4, XD5, XD6, XD7, YD1, YD2, YD3, YD4, YD5, YD6, YD7, WD1, WD2, WD3, WD6, WD7

Transmission 722.681 in models 903.61/66/67, 904.61/66 with code (G40) Automatic transmission with code (ZU7) National version for Canada

Transmission 722.681 in models 903.61/66/67, 904.61/66 with code (G40) Automatic transmission with code (ZU8) National version for USA

Transmission 722.681 in models 903.61/62/66/67, 904.61/62/66 with code (G40) Automatic transmission with code (ZU9) National version for Mexico

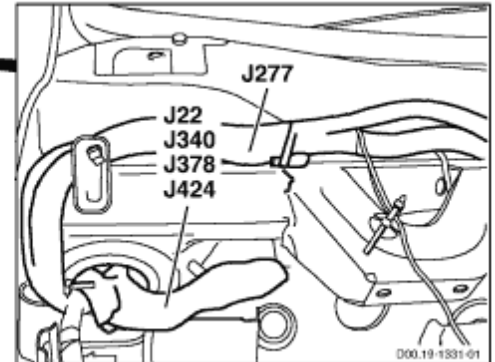
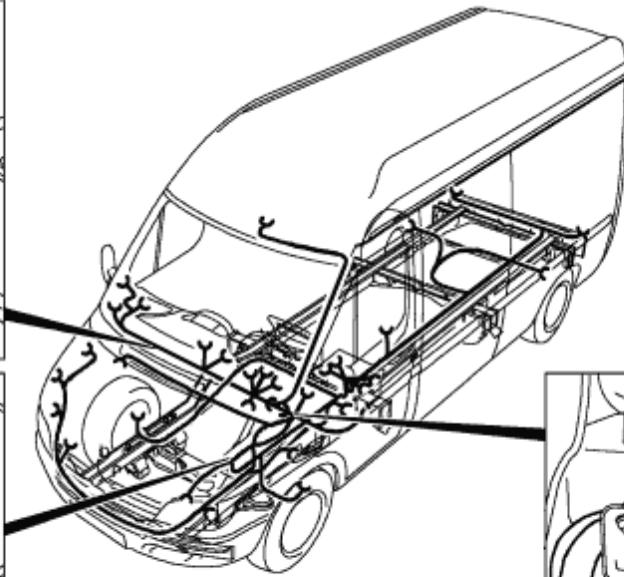
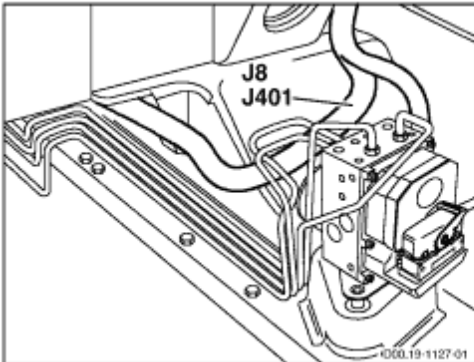
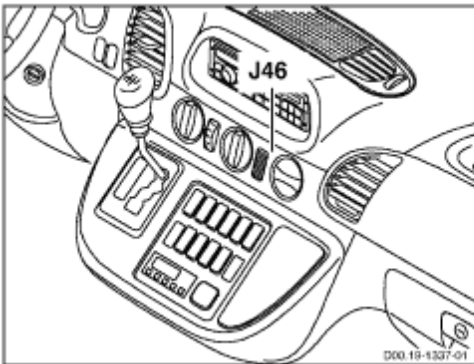

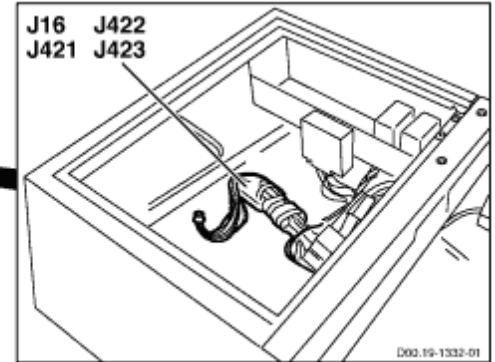
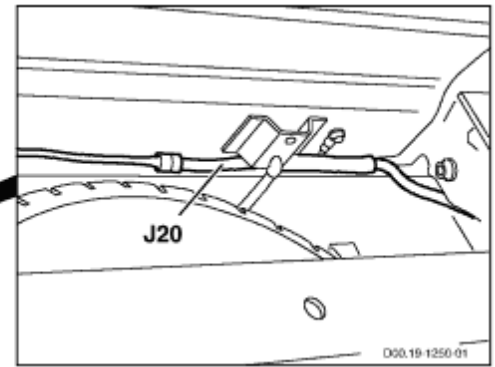
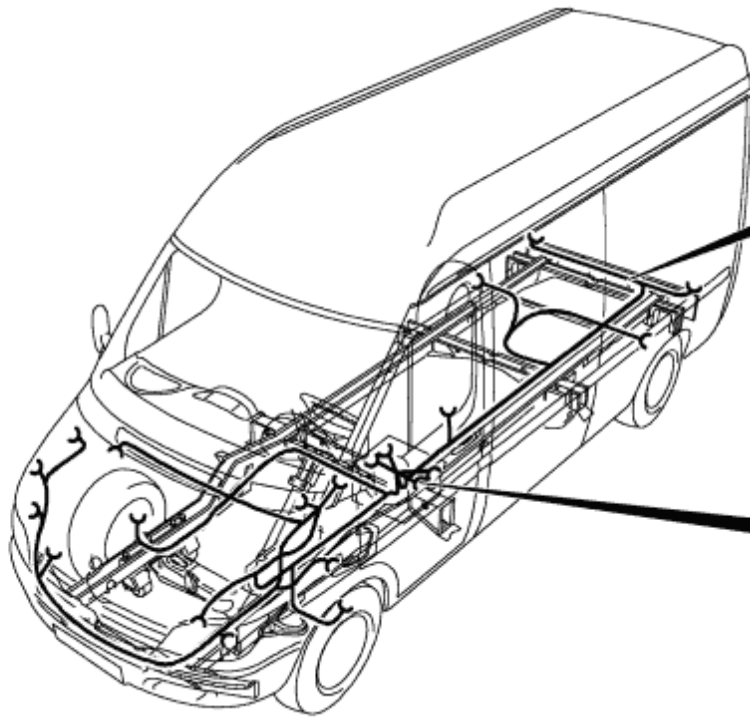

D00.19-1356-09

Terminal block	Designation		Component	Designation	Connector Pin
J8	FWH/engine compartment (behind battery)	→	A2	ABS/ESP control unit	1.32
	Stop light connector sleeve	→	A93	Trailer socket control unit	2.A
		→	B127	Stop light switch 6-pin	2.2
		→	J15	Stop light connector sleeve	
		→	X45	Frame/roof connector (standard)	2
J16	FWH/seat frame (behind rubber grommet)	→	F6	ABS circuit 30 fuse	1
	Circuit 30 connector sleeve	→	F7	ABS circuit 30 fuse	1
		→	F9	Additional heater fuse (25 A)	1
		→	F11	Instrument cluster fuse (7.5 A)	1
		→	F40	Daytime running lamps fuse	1
		→	F43	Radio remote control fuse (10 A)	1
		→	F44	Central locking fuse (25 A)	1
		→	F62	Interior light fuse (15 A)	1
		→	F63	Heated rear window fuse (30 A)	1

		→	F98	Warm water heater stage 1 blower fuse (10 A)	1
		→	F101	Warm air additional heater fuse (7.5 A)	1
		→	F114	Additional heat exchanger fuse (25 A)	1
		→	F119	Air conditioning additional fan fuse (30 A)	1
		→	F138	Circuit 15 fuse (10 A)	1
		→	F140.3	Circuit 30 fuse (125 A)	2
		→	F143	Additional heater fuse (25 A)	1
		→	F148	Daytime running lamps relay fuse (10 A)	1
		→	F149	Roof AC fuse (40 A)	1
		→	F151	Fog lamp fuse (7.5 A)	1
		→	F153	Trailer socket fuse (25 A)	1
		→	F154	Instrument panel socket fuse (15 A)	1
		→	J327	Circuit 30 unfused connector sleeve	
		→	K26	Circuit D+ relay	1
J20	FWH (close to ground point W6)	→	E67e19	Left backup lamp	4
	Reversing lamp connector sleeve	→	E68E1	Right backup lamp	4
		→	X217	Frame/waistrail connector	1
		→	X232	Trailer socket connector	3
J22	FWH/waistrail (next to firewall rubber grommet)	→	A12	Electrical center	4.7
	Circuit 15 fused connector sleeve	→	A62	WSP control unit	7
		→	H17	Horn	2
		→	K37	Horn relay	4
		→	K70	Circuit 15 relay for optional equipment	2
		→	K103	Circulation pump relay	3
		→	K138	Circuit 15 relay	2
		→	X79	Frame/waistrail connector	1
		→	X80	Frame/waistrail connector	3
J46	WWH (middle of instrument panel)	→	A9	Radio	1.A6
	Circuit 58 connector sleeve	→	A40	EWM control unit	2

		→	A71	Heater timer	1
		→	A81	Air conditioning pushbutton control and operating unit	1.9
		→	E104	Ashtray lighting	1
		→	S12	Driver seat heater switch	1
		→	S25	Headlamp range adjustment switch	9
		→	S48	ASR switch	1
		→	S57	Differential lock switch	1
		→	S81	Rear window defroster pushbutton	1
		→	S85	Driver interior lighting pushbutton	1
		→	S87	Auxiliary heater switch	1
		→	S90	Roof fan switch	1
		→	S92	Panic alarm button	1
		→	S99	ATA [EDW] towing/interior motion sensor button	1
		→	S100	Additional heat exchanger double-contact pushbutton	1
		→	S107	Front passenger seat heater switch	1
		→	S119.1	Fog light switch	1
		→	S124	Reading lamp switch	1
		→	S126	Interior pushbutton	1
		→	S137	Roof AC switch	1
		→	S138	Temperature switch	9
		→	X79	Frame/waistrail connector	2
		→	X234	Cigar lighter illumination plug connection	3
J277	FWH/waistrail (behind instrument cluster)	→	A12	Electrical center	5.1
	Circuit 15 connector sleeve	→	B127	Stop light switch 6-pin	1.2 2.1
		→	P17	Diagnostic socket 16-pin	8
J340	FWH/waistrail (next to firewall rubber grommet)	→	A2	ABS/ESP control unit	1.24
	CAN-high connector sleeve	→	A62	WSP control unit	5
		→	J422	CAN-high connector sleeve	
		→	P15	Instrument cluster	1.18

		→	X82	Frame/waistrail connector	3
		→	X217	Frame/waistrail connector	7
J378	FWH/waistrail (next to firewall rubber grommet)	→	A2	ABS/ESP control unit	1.40
	CAN-low connector sleeve	→	A62	WSP control unit	6
		→	J421	CAN-low connector sleeve	
		→	P15	Instrument cluster	1.17
		→	X82	Frame/waistrail connector	4
		→	X217	Frame/waistrail connector	8
J401	FWH/engine compartment (behind battery)	→	A2	ABS/ESP control unit	11
	Diagnostic cable connector sleeve	→	P17	Diagnostic socket 16-pin	9
		→	X217	Frame/waistrail connector	4
J421	FWH/seat frame (behind rubber grommet)	→	A4	ETC control unit	2.L
	CAN-low connector sleeve	→	A80	CDI control unit	2.12
		→	J378	CAN-low connector sleeve	
J422	FWH/seat frame (behind rubber grommet)	→	A4	ETC control unit	2.H
	CAN-high connector sleeve	→	A80	CDI control unit	2.11
		→	J340	CAN-high connector sleeve	
J423	FWH/seat frame (behind rubber grommet)	→	A4	ETC control unit	1.29
	Circuit 87 connector sleeve	→	K138	Circuit 15 relay	5
		→	X217	Frame/waistrail connector	6
J424	FWH/waistrail (next to firewall rubber grommet)	→	A4	ETC control unit	1.1
	Diagnostic cable connector sleeve	→	P17	Diagnostic socket 16-pin	11

PE42.45-D-2200-99B

[Display in a separate window](#)

To display wiring diagrams, you need a
JAVA 1.1 capable Browser like e.g. "Microsoft Internet Explorer 4.0"
or
"Netscape Navigator 4.05" and higher with AWT 1.1 support

A2	ABS control module
A2	ABS control module
A2	ABS control module
A2	ABS control module
A12	Electrical center
B18	4-pin stop lamp switch
B79	Left front wheel speed sensor
B80	Right front wheel speed sensor
B81	Left rear wheel speed sensor
B82	Right rear wheel speed sensor
B143	Steering angle sensor
B144	Lateral acceleration sensor
F5	ABS fuse
F6	ABS fuse, terminal 30
F7	ABS fuse, terminal 30
J8	Stop lamp connector sleeve
J16	Circuit 30 connector sleeve
J31	Terminal 15 connector sleeve, fused
J46	Terminal 58 connector sleeve
J105	Terminal 15 connector sleeve
J132	Right rear wheel speed sensor connector sleeve
J134	Left rear wheel speed sensor ground connector sleeve
J135	Left rear wheel speed sensor connector sleeve

J136 Right rear wheel
speed sensor
ground connector
sleeve

J277 Terminal 15
connector sleeve

J332 Terminal 15
connector sleeve,
fused

J340 CAN High connector
sleeve

J378 CAN Low connector
sleeve

J401 Diagnostic line
connector sleeve

P17 Diagnostic socket
16-pin

S48 ASR switch

W4 Ground point firewall

W7 Ground point
(engine
compartment)

W8 Ground point
(waistrail)

W27 Ground point (ABS)

X79 Frame/waistrail
connector

PE42.45-D-2200-60B	Legend of wiring diagram for electronic stability program (ESP)	<p>MODELS XD1, XD2, XD3, XD6, XD7, YD1, YD2, YD3, YD6, YD7, WD1, WD2, WD3, WD6, WD7</p> <p>MODELS 903.61 /66 /67 with CODE (BB3) Electronic Stability Program with CODE (ZU7) National version for Canada</p> <p>MODELS 903.61 /66 /67 with CODE (BB3) Electronic Stability Program with CODE (ZU8) National version for USA</p>	
--------------------	---	--	--

Code	Designation	Coordinate
A2	ABS/ESP control unit	4A 12A 20A 28A
A12	Electrical center	8L
B18	Stop light switch 4-pin	5L
B79	Left front wheel speed sensor	17L
B80	Right front wheel speed sensor	19L
B81	Left rear wheel speed sensor	20L
B82	Right rear wheel speed sensor	22L
B143	Steering angle sensor	12L
B144	Lateral acceleration sensor	25L
F5	ABS fuse	10G
F6	ABS fuse, circuit 30	1G
F7	ABS fuse, circuit 30	2G
J8	Stop light connector sleeve	6E
J16	Circuit 30 connector sleeve	1L
J31	Circuit 15 fused connector sleeve	10L
J46	Circuit 58 connector sleeve	28G
J105	Circuit 15 connector sleeve	27G
J132	Rear right wheel speed sensor connector sleeve	22G
J134	Left rear wheel speed sensor ground connector sleeve	21G
J135	Left rear wheel speed sensor connector sleeve	20G

J136	Right rear wheel speed sensor ground connector sleeve	23G
J277	Circuit 15 connector sleeve	5E
J332	Circuit 15 fused connector sleeve	10E
J340	CAN-high connector sleeve	14G
J378	CAN-low connector sleeve	14G
J401	Diagnostic cable connector sleeve	16E
P17	Diagnostic socket 16-pin	16L
S48	ASR switch	28L
W4	Firewall ground point	13G
W7	Engine compartment ground point	3E
W8	Ground point waistrail	29G
W27	Ground point ABS	3E
X79	Frame/waistrail connector	26E

PE72.29-D-2001-99D

[Display in a separate window](#)

To display wiring diagrams, you need a
JAVA 1.1 capable Browser like e.g. "Microsoft Internet Explorer 4.0"
or
"Netscape Navigator 4.05" and higher with AWT 1.1 support

F52	Front passenger door power window fuse (25 A)
F53	Driver door power window fuse (25 A)
J31	Terminal 15 connector sleeve, fused
J109	Tml. 31 connector sleeve
J152	Circuit 15, fused, connector sleeve
J152	Circuit 15, fused, connector sleeve
M27	Driver door power window motor
M28	Front passenger door power window motor
S106	Front passenger power window switch (driver door)
S108	Driver power window switch (driver door)
S109	Front passenger power window switch (front passenger door)
W8	Ground point (waistrail)
X74	Driver power window connector
X75	Front passenger power window connector
X80	Frame/waistrail connector
X202	Power window switch connector (driver door)
X202	Power window switch connector (driver door)
X203	Power window switch connector (front passenger)

door)

PE72.29-D-2001-60D	Legend of wiring diagram of power windows	<p>MODEL XD1, XD2, XD3, XD4, XD5, XD6, XD7, YD1, YD2, YD3, YD4, YD5, YD6, YD7, WD1, WD2, WD3, WD6, WD7</p> <p>MODEL 903.61 /66 /67, 904.61 /66 with CODE (V50) Two power windows with CODE (ZU7) National version for Canada</p> <p>MODEL 903.61 /66 /67, 904.61 /66 with CODE (V50) Two power windows with CODE (ZU8) National version for USA</p> <p>MODEL 903.61 /62 /66 /67, 904.61 /62 /66 with CODE (V50) Two power windows with CODE (ZU9) National version for Mexico</p>	
--------------------	---	---	--

Code	Designation	Coordinate
F52	Front passenger door power window fuse (25 A)	2J
F53	Driver door power window fuse (25 A)	3J
J31	Circuit 15 fused connector sleeve	3L
J109	Circuit 31 connector sleeve	4E
J152	Circuit 15 fused connector sleeve	7G 12G
M27	Driver door power window motor	1L
M28	Front passenger door power window motor	14L
S106	Front passenger power window switch (driver door)	8A
S108	Driver power window switch (driver door)	3A
S109	Front passenger power window switch (front passenger door)	12A
W8	Waistrail ground point	6G
X74	Driver power window connector	1E
X75	Front passenger power window connector	13E
X80	Frame/waistrail connector	2G
X202	Power window switch connector (driver door)	2E 5E

X203	Power window switch connector (front passenger door)	10E
------	--	-----

GF00.19-D-3100-29C	Arrangement and assignment of terminal block connectors power windows	<p>Models XD1, XD2, XD3, XD4, XD5, XD6, XD7, YD1, YD2, YD3, YD4, YD5, YD6, YD7, WD1, WD2, WD3, WD6, WD7</p> <p>Models 903.61/66/67, 904.61/66 with code (V50) Power window (2 doors) with code (ZU7) National version for Canada</p> <p>Models 903.61/66/67, 904.61/66 with code (V50) Power window (2 doors) with code (ZU8) National version for USA</p> <p>Models 903.61/62/66/67, 904.61/62/66 with code (V50) Power window (2 doors) with code (ZU9) National version for Mexico</p>	
--------------------	---	---	--

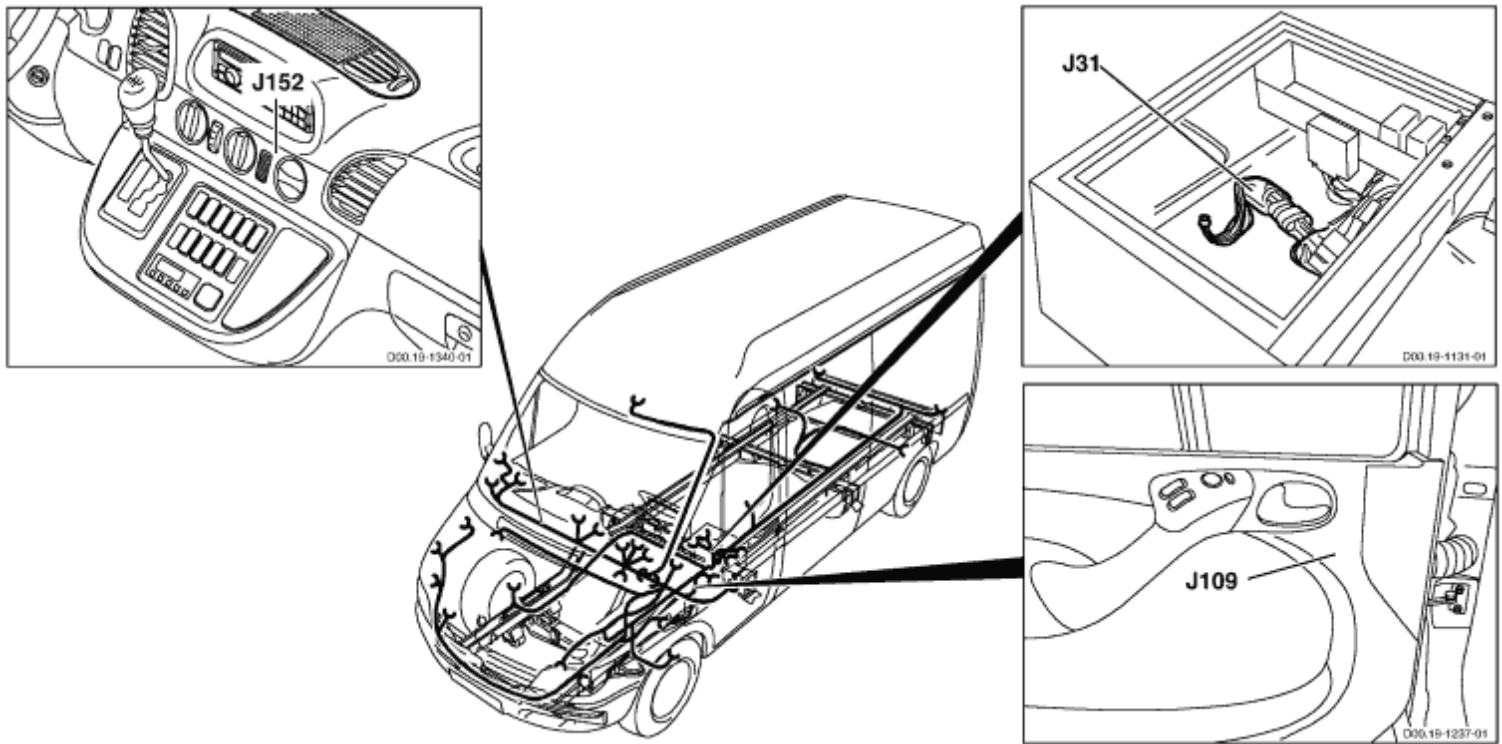

D00.19-1368-09

Terminal block	Designation	Component	Designation	Connector
----------------	-------------	-----------	-------------	-----------

					Pin
J31	FWH/seat frame (behind rubber grommet)	→	F5	ABS terminal 15 fuse	1
	Circuit 15 fused connector sleeve	→	F52	Front passenger door power window fuse (25 A)	1
		→	F53	Driver door power window fuse (25 A)	1
		→	F54	Heated and adjustable exterior mirror fuse (10 A)	1
		→	F86	EDW circuit 15 fuse (7.5 A)	1
		→	F127	Differential lock fuse (15 A)	1
		→	F128	Driver, passenger seat heater fuse (15 A)	1
		→	F139	Additional heater fuse (10 A)	1
		→	F150	Roof fan fuse (15 A)	1
		→	K70	Circuit 15 relay for optional equipment	1
J109	TLS (close to S108)	→	S106	Front passenger (driver) power window switch	3 5
	Tml. 31 connector sleeve	→	S108	Driver door power window switch	3 5
		→	X202	Power window switch connector (driver door)	1
J152	WWH (middle of instrument panel)	→	X80	Frame/waistrail connector	18
	Circuit 15 fused connector sleeve	→	X202	Power window switch connector (driver door)	3
		→	X203	Power window switch connector (front passenger door)	2

PE80.35-D-2200-99C

[Display in a separate window](#)

To display wiring diagrams, you need a
JAVA 1.1 capable Browser like e.g. "Microsoft Internet Explorer 4.0"
or
"Netscape Navigator 4.05" and higher with AWT 1.1 support

A8	Central locking control module
A12	Electrical center
A47	Transponder
A62	WSP control module
A62	WSP control module
A62	WSP control module
A82	ATA 2 control module
F43	Radio remote control fuse (10 A)
J6	Circuit 30, fused, connector sleeve
J6	Circuit 30, fused, connector sleeve
J16	Circuit 30 connector sleeve
J22	Circuit 15, fused, connector sleeve
J80	Right turn signal lamp connector sleeve
J81	Left turn signal lamp connector sleeve
J340	CAN High connector sleeve
J378	CAN Low connector sleeve
J380	ATA turn signal relay connector sleeve
J388	Circuit 30, fused, connector sleeve
K101	Left turn signal light ATA relay
K102	Right turn signal light ATA relay
P17	Diagnostic socket 16-pin
W4	Ground point firewall
W30	Radio remote control antenna
X160	Transponder connector
X194	ATA 2 connector



PE80.35-D-2200-60C	Legend of wiring diagram of remote central locking with immobilizer and transponder	<p>MODEL XD1, XD2, XD3, XD4, XD5, XD6, XD7, YD1, YD2, YD3, YD4, YD5, YD6, YD7, WD1, WD2, WD3, WD6, WD7</p> <p>MODEL 903.61 /66 /67, 904.61 /66 with CODE (ZU7) National version for Canada</p> <p>MODEL 903.61 /66 /67, 904.61 /66 with CODE (ZU8) National version for USA</p> <p>MODEL 903.61 /62 /66 /67, 904.61 /62 /66 with CODE (ZU9) National version for Mexico</p>	
--------------------	---	---	--

Code	Designation	Coordinate
A8	Central locking control unit	17L
A12	Electrical center	11L
A47	Transponder coil	22L
A62	WSP control unit	4A 12A 20A
A82	ATA control unit	20L
F43	Radio remote control fuse (10 A)	1G
J6	Circuit 30 fused connector sleeve	2G 9G
J16	Circuit 30 connector sleeve	1L
J22	Circuit 15 fused connector sleeve	10E
J80	Right turn signal light connector sleeve	6G
J81	Left turn signal light connector sleeve	5G
J340	CAN-high connector sleeve	14G
J378	CAN-low connector sleeve	13G
J380	ATA turn signal relay connector sleeve	3G
J388	Circuit 30 fused connector sleeve	1E
K101	Left ATA turn signal lamp relay	3L
K102	Right ATA turn signal lamp relay	8L
P17	Diagnostic socket 16-pin	13E

W4	Firewall ground point	9E
W30	Radio remote control antenna	16L
X160	Transponder connector	21H
X194	ATA [ATA] connector	20H

GF00.19-D-3100-32C	Arrangement and assignment of terminal block connectors radio remote control with immobilizer and transponder	<p>Models XD1, XD2, XD3, XD4, XD5, XD6, XD7, YD1, YD2, YD3, YD4, YD5, YD6, YD7, WD1, WD2, WD3, WD6, WD7</p> <p>Models 903.61/66/67, 904.61/66 with code (ZU7) National version for Canada</p> <p>Models 903.61/66/67, 904.61/66 with code (ZU8) National version for USA</p> <p>Models 903.61/62/66/67, 904.61/62/66 with code (ZU9) National version for Mexico</p>	
--------------------	---	--	--

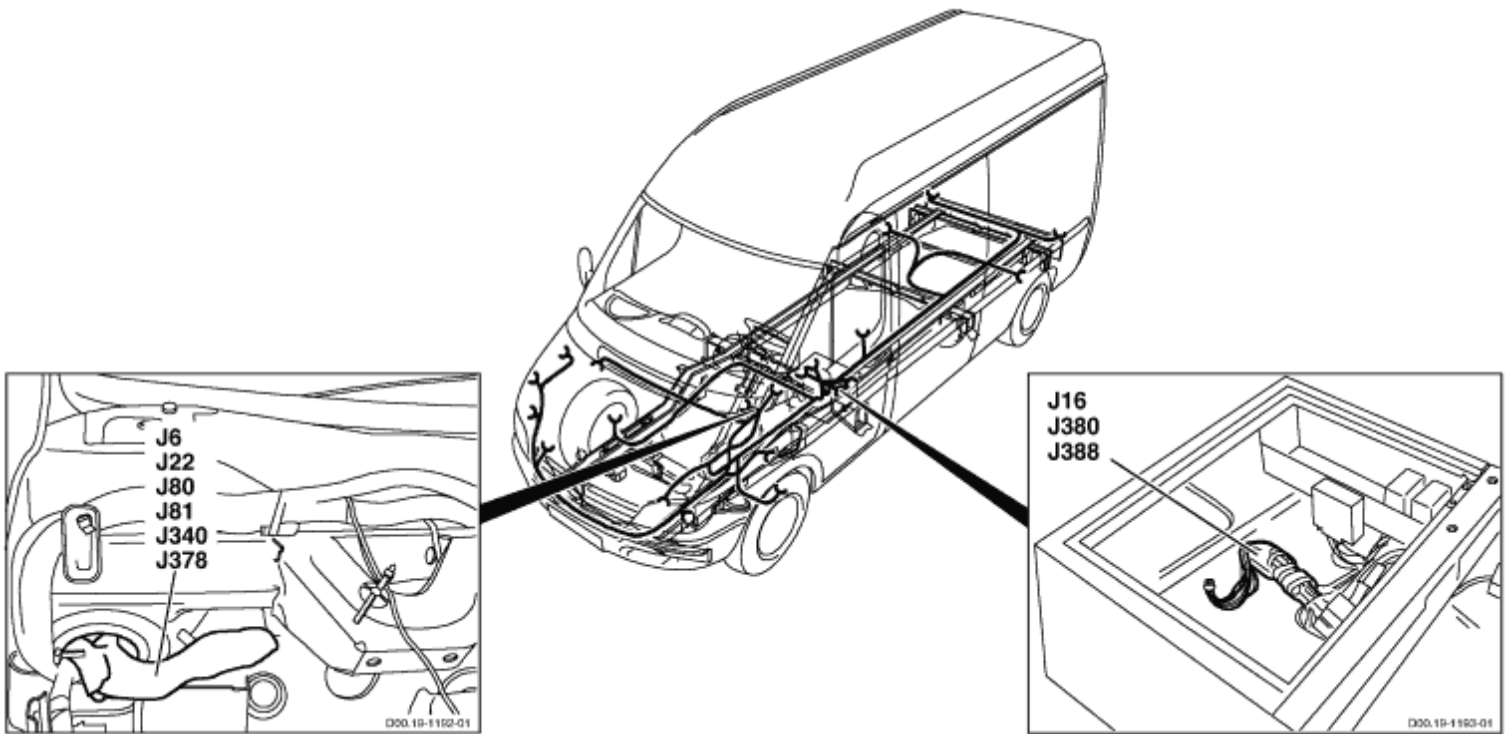

D00.19-1191-09

Terminal block	Designation		Component	Designation	Connector Pin
J6	FWH/waistrail (next to firewall rubber grommet)	→	A12	Electrical center	4.11
	Circuit 30 fused connector sleeve	→	K101	Left EDW turn signal lamp relay	5

		→	K102	Right EDW turn signal lamp relay	5
		→	X45	Frame/roof connector (standard)	1
		→	X79	Frame/waistrail connector	8
J16	FWH/seat frame (behind rubber grommet)	→	F6	ABS circuit 30 fuse	1
	Circuit 30 connector sleeve	→	F7	ABS circuit 30 fuse	1
		→	F9	Additional heater fuse (25 A)	1
		→	F11	Instrument cluster fuse (7.5 A)	1
		→	F40	Daytime running lamps fuse	1
		→	F43	Radio remote control fuse (10 A)	1
		→	F44	Central locking fuse (25 A)	1
		→	F62	Interior light fuse (15 A)	1
		→	F63	Heated rear window fuse (30 A)	1
		→	F98	Warm water heater stage 1 blower fuse (10 A)	1
		→	F101	Warm air additional heater fuse (7.5 A)	1
		→	F114	Additional heat exchanger fuse (25 A)	1
		→	F119	Air conditioning additional fan fuse (30 A)	1
		→	F138	Circuit 15 fuse (10 A)	1
		→	F140.3	Circuit 30 fuse (125 A)	2
		→	F143	Additional heater fuse (25 A)	1
		→	F148	Daytime running lamps relay fuse (10 A)	1
		→	F149	Roof AC fuse (40 A)	1
		→	F151	Fog lamp fuse (7.5 A)	1
		→	F153	Trailer socket fuse (25 A)	1
		→	F154	Instrument panel socket fuse (15 A)	1
		→	J327	Circuit 30 unfused connector sleeve	
		→	K26	Circuit D+ relay	1
J22	FWH/waistrail (next to firewall rubber grommet)	→	A12	Electrical center	4.7
	Circuit 15 fused connector sleeve	→	A62	WSP control unit	7
		→	H17	Horn	2

		→	K37	Horn relay	4
		→	K70	Circuit 15 relay for optional equipment	2
		→	K103	Circulation pump relay	3
		→	K138	Circuit 15 relay	2
		→	X79	Frame/waistrail connector	1
		→	X80	Frame/waistrail connector	3
J80	FWH/waistrail (next to firewall rubber grommet)	→	A12	Electrical center	5.5
	Right turn signal light connector sleeve	→	A82	EDW control unit	1.4
		→	A93	Trailer socket control unit	2.B
		→	E26H3	Right front turn signal lamp	6
		→	E68h4	Right rear turn signal lamp	5
		→	H2	Right front side turn signal lamp (5 W)	1
		→	H9	Right front side turn signal lamp (21 W)	1
		→	K102	Right EDW turn signal lamp relay	1
		→	P15	Instrument cluster	1.7
J81	FWH/waistrail (next to firewall rubber grommet)	→	A12	Electrical center	5.8
	Left turn signal light connector sleeve	→	A62	WSP control unit	8
		→	A82	EDW control unit	1.1
		→	A93	Trailer socket control unit	2.E
		→	E25h21	Left front turn signal lamp	6
		→	E67h22	Left rear turn signal lamp	5
		→	H5	Left front side turn signal lamp (5 W)	1
		→	H10	Left front side turn signal lamp (21 W)	1
		→	K101	Left EDW turn signal lamp relay	1
		→	P15	Instrument cluster	2.13
J340	FWH/waistrail (next to firewall rubber grommet)	→	A2	ABS/ESP control unit	1.24
	CAN-high connector sleeve	→	A62	WSP control unit	5
		→	J422	CAN-high connector sleeve	

		→	P15	Instrument cluster	1.18
		→	X82	Frame/waistrail connector	3
		→	X217	Frame/waistrail connector	7
J378	FWH/waistrail (next to firewall rubber grommet)	→	A2	ABS/ESP control unit	1.40
	CAN-low connector sleeve	→	A62	WSP control unit	6
		→	J421	CAN-low connector sleeve	
		→	P15	Instrument cluster	1.17
		→	X82	Frame/waistrail connector	4
		→	X217	Frame/waistrail connector	8
J380	FWH/seat frame (behind rubber grommet)	→	A62	WSP control unit	10
	EDW turn signal relay connector sleeve	→	K101	Left EDW turn signal lamp relay	2
		→	K102	Right EDW turn signal lamp relay	2
J388	FWH/seat frame (behind rubber grommet)	→	A62	WSP control unit	3
	Circuit 30 fused connector sleeve	→	F43	Radio remote control fuse (10 A)	2
		→	K101	Left EDW turn signal lamp relay	4
		→	K102	Right EDW turn signal lamp relay	4

PE54.30-D-2001-99G

[Display in a separate window](#)

To display wiring diagrams, you need a
JAVA 1.1 capable Browser like e.g. "Microsoft Internet Explorer 4.0"
or
"Netscape Navigator 4.05" and higher with AWT 1.1 support

A9	Car radio
A10	Airbag control module
A12	Electrical center
A98	Telephone box control module
B3	Fuel level sensor
B7	Switch for engine coolant level
B37	Ambient temperature sensor
B54	Brake fluid switch, LHS
F11	Instrument cluster fuse (7.5 A)
G1	Alternator
G5	Left front brake wear indicator sensor
G6	Right front brake wear indicator sensor
G7	Left rear brake wear indicator sensor
G8	Right rear brake wear indicator sensor
J2	Brake wear indicator signal connector sleeve
J3	Interior light connector sleeve
J16	Circuit 30 connector sleeve
J16	Circuit 30 connector sleeve
J18	Circuit 15, fused, connector sleeve
J30	Rear brake wear indicator signal connector sleeve
J38	Circuit 56 connector sleeve
J39	Brake wear indicator ground connector sleeve
J80	Right turn signal

	lamp connector sleeve
J81	Left turn signal lamp connector sleeve
J89	Circuit 56b connector sleeve
J277	Terminal 15 connector sleeve
J372	Diagnostic line connector sleeve
J394	Vehicle speed signal connector sleeve
J415	Circuit 30 connector sleeve
J446	Circuit 58 connector sleeve
J483	Vehicle speed signal connector sleeve
K26	Circuit D+ relay
P15	Instrument cluster
P15	Instrument cluster
P15	Instrument cluster
P15	Instrument cluster
P15	Instrument cluster
P17	Diagnostic socket 16-pin
P17	Diagnostic socket 16-pin
S42	Left door contact switch
S43	Right door contact switch
S76	Seat belt buckle switch
S80	Parking brake switch
S139	Ignition lock switch
W4	Ground point firewall
W4	Ground point firewall
W4	Ground point firewall
W5	Ground point seat frame
W5	Ground point seat frame
W5	Ground point seat

	frame
W5	Ground point seat frame
W6	Ground point taillamp
W7	Ground point (engine compartment)
X4.2	Fuel tank sensor connector
X4.3	Fuel tank sensor/pump connector
X45	Frame/roof connector (standard)
X79	Frame/waistrail connector
X195	Frame/engine connector
X209	Engine/Generator connector
X237	Air mass meter connector

PE54.30-D-2001-60G	Legend of wiring diagram large instrument (instrument cluster)	<p>MODEL XD1, XD2, XD3, XD4, XD5, XD6, XD7, YD1, YD2, YD3, YD4, YD5, YD6, YD7, WD1, WD2, WD3, WD6, WD7</p> <p>MODEL 903.61 /66 /67, 904.61 /66 with CODE (J65) outside temperature indicator with CODE (ZU7) national version for Canada</p> <p>MODEL 903.61 /66 /67, 904.61 /66 with CODE (J65) outside temperature indicator with CODE (ZU8) national version for USA</p> <p>MODEL 903.61 /62 /66 /67, 904.61 /62 /66 with CODE (J65) outside temperature indicator with CODE (ZU9) national version for Mexico</p>	
--------------------	--	---	--

Code	Designation	Coordinate
A9	Radio	36L
A10	Airbag control unit	31L
A12	Electrical center	23L
A98	Telephone box control unit	34L
B3	Fuel level sensor	14L
B7	Coolant level switch	12L
B37	Outside temperature sensor	20L
B54	Brake fluid switch LHS	5L
F11	Instrument cluster fuse (7.5 A)	31G
G1	Alternator	38L
G5	Left front brake wear indicator sensor	7L
G6	Right front brake wear indicator sensor	8L
G7	Left rear brake wear indicator sensor	9L
G8	Right rear brake wear indicator sensor	11L
J2	Brake wear indicator signal connector sleeve	8E
J3	Interior light connector sleeve	1G

J16	Tml. 30 connector sleeve	24G 32L
J18	Circuit 15 fused connector sleeve	23E
J30	Rear brake wear indicator signal connector sleeve	8G
J38	Circuit 56a connector sleeve	28G
J39	Brake wear indicator ground connector sleeve	9G
J80	Right turn signal light connector sleeve	21G
J81	Left turn signal light connector sleeve	22G
J89	Circuit 56b connector sleeve	26G
J277	Circuit 15 connector sleeve	23G
J372	Diagnostic cable connector sleeve	18G
J394	Vehicle speed signal connector sleeve	34E
J415	Tml. 30 connector sleeve	31E
J446	Circuit 58 connector sleeve	29G
J483	Vehicle speed signal connector sleeve	35G
K26	Circuit D+ relay	26L
P15	Instrument cluster	4A 12A 20A 28A 36A
P17	Diagnostic socket 16-pin	18L 33L
S42	Left door contact switch	1L
S43	Right door contact switch	3L
S76	Seat belt buckle switch	19L
S80	Parking brake switch	4L
S139	Ignition lock switch	41L
W4	Firewall ground point	7G 24E 40G
W5	Seat frame ground point	4G 19G 25G 27G
W6	Ground point taillamp	10L
W7	Engine compartment ground point	12G

X4.2	Fuel level sensor connector	13G
X4.3	Fuel level sensor/pump connector	13H
X45	Frame/roof connector (standard)	1E
X79	Frame/waistrail connector	35E
X195	Frame/engine connector	37E
X209	Engine/alternator connector	37H
X237	Frame/engine connector	39E

GF00.19-D-3100-24C

Arrangement and assignment of terminal block connectors instrument cluster

Models XD1, XD2, XD3, XD4, XD5, XD6, XD7, YD1, YD2, YD3, YD4, YD5, YD6, YD7, WD1, WD2, WD3, WD6, WD7
Models 903.61/66/67, 904.61/66
with code (J65) Outside temperature indicator
with code (ZU7) National version for Canada
Models 903.61/66/67, 904.61/66
with code (J65) Outside temperature indicator
with code (ZU8) National version for USA
Models 903.61/62/66/67, 904.61/62/66
with code (J65) Outside temperature indicator
with code (ZU9) National version for Mexico

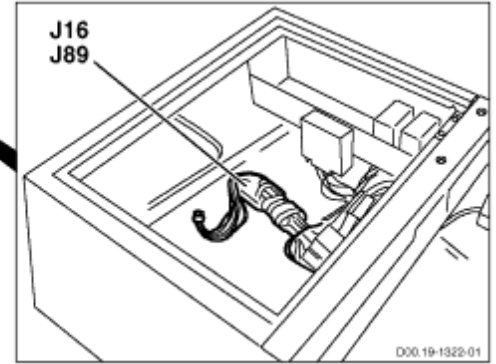
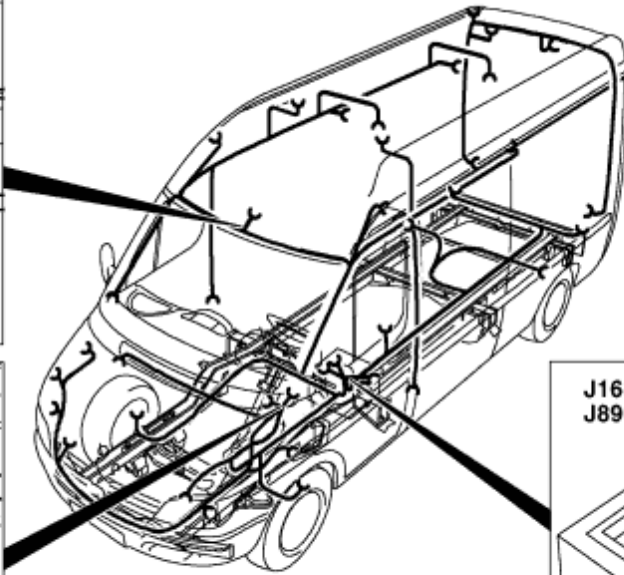
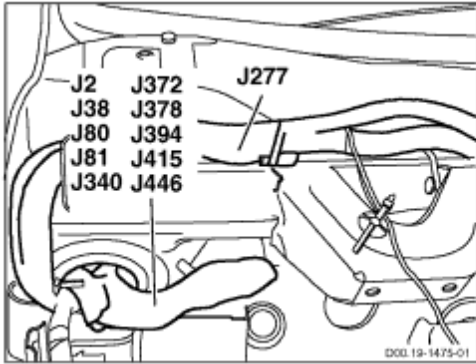
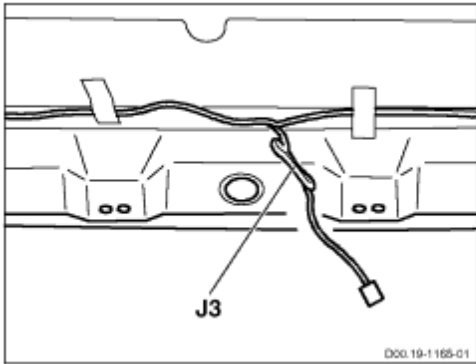

D00.19-1476-09

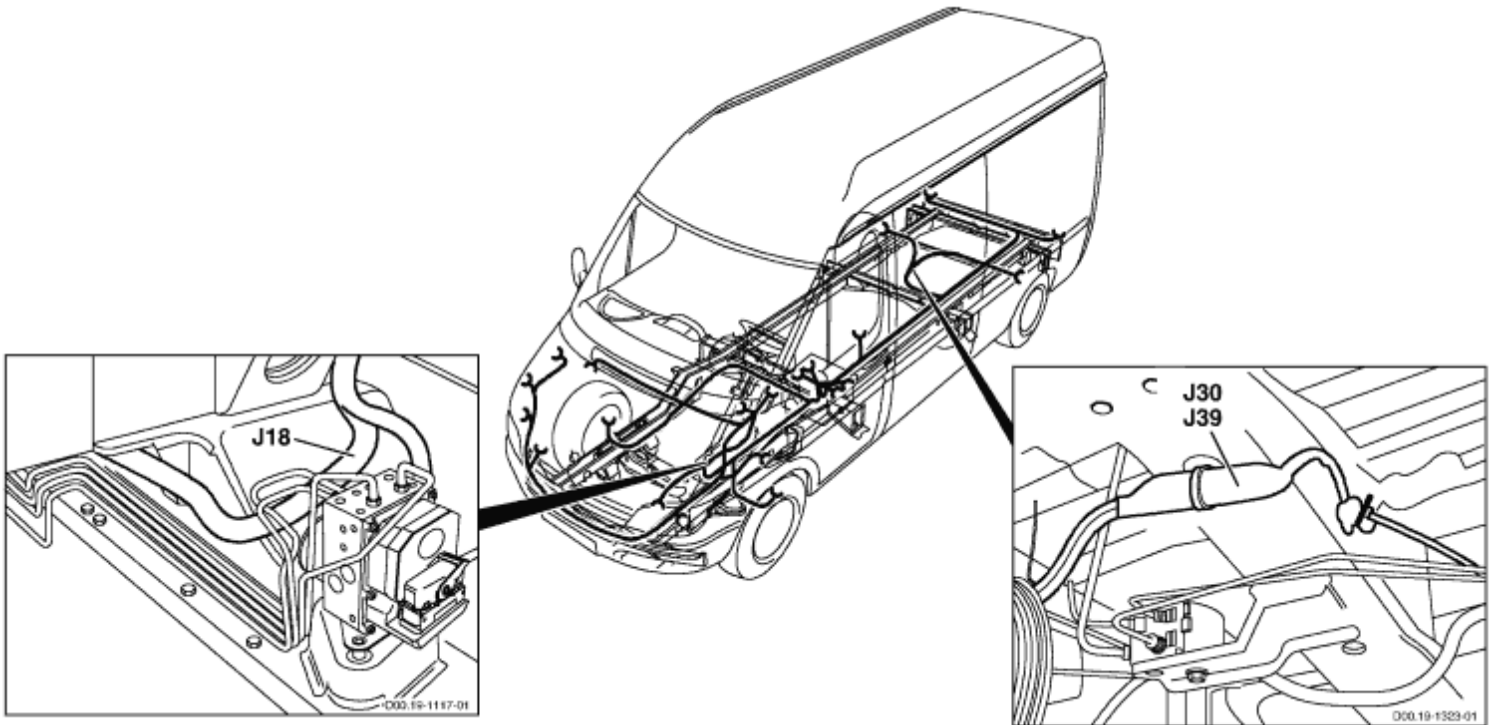

D00.19-1365-09

Terminal block	Designation		Component	Designation	Connector Pin
J2	FWH/waistrail (next to firewall rubber grommet)	→	G5	Left front brake wear indicator sensor	2
	Brake wear indicator signal connector sleeve	→	G6	Right front brake wear indicator sensor	2
		→	J30	Rear brake wear indicator signal connector sleeve	
		→	P15	Instrument cluster	2.4
J3	RWH (close to E43)	→	E31	Driver entry lamp	2
	Interior light connector sleeve	→	E32	Front passenger entry lamp	2
		→	E43	Cab lamp	3
		→	S42	Left door contact switch	
		→	S43	Right door contact switch	
		→	X45	Frame/roof connector (standard)	5
		→	X193	Frame/roof connector	2
J16	FWH/seat frame (behind rubber grommet)	→	F6	ABS circuit 30 fuse	1
	Circuit 30 connector sleeve	→	F7	ABS circuit 30 fuse	1

		→	F9	Additional heater fuse (25 A)	1
		→	F11	Instrument cluster fuse (7.5 A)	1
		→	F40	Daytime running lamps fuse	1
		→	F43	Radio remote control fuse (10 A)	1
		→	F44	Central locking fuse (25 A)	1
		→	F62	Interior light fuse (15 A)	1
		→	F63	Heated rear window fuse (30 A)	1
		→	F98	Warm water heater stage 1 blower fuse (10 A)	1
		→	F101	Warm air additional heater fuse (7.5 A)	1
		→	F114	Additional heat exchanger fuse (25 A)	1
		→	F119	Air conditioning additional fan fuse (30 A)	1
		→	F138	Circuit 15 fuse (10 A)	1
		→	F140.3	Circuit 30 fuse (125 A)	2
		→	F143	Additional heater fuse (25 A)	1
		→	F148	Daytime running lamps relay fuse (10 A)	1
		→	F149	Roof AC fuse (40 A)	1
		→	F151	Fog lamp fuse (7.5 A)	1
		→	F153	Trailer socket fuse (25 A)	1
		→	F154	Instrument panel socket fuse (15 A)	1
		→	J327	Circuit 30 unfused connector sleeve	
		→	K26	Circuit D+ relay	1
J18	FWH/engine compartment (behind battery)	→	A10	Airbag control unit	1.5
	Circuit 15 fused connector sleeve	→	A12	Electrical center	4.3
		→	A80	CDI control unit	2.13
		→	K79	Circuit 15 body manufacturer relay	4
		→	P15	Instrument cluster	2.10
J30	FWH (cross member rear spring bracket at front; cast)	→	G7	Left rear brake wear indicator sensor	2
	Rear brake wear indicator signal connector sleeve	→	G8	Right rear brake wear indicator sensor	2

		→	J2	Brake wear indicator signal connector sleeve	
J38	FWH/waistrail (next to firewall rubber grommet)	→	A12	Electrical center	4.5
	Circuit 56a connector sleeve	→	E25e66	Left high beam	9
		→	P15	Instrument cluster	2.8
J39	FWH (cross member rear spring bracket at front; cast)	→	G7	Left rear brake wear indicator sensor	1
	Brake wear indicator ground connector sleeve	→	G8	Right rear brake wear indicator sensor	1
		→	W6	Ground point taillamp	
J80	FWH/waistrail (next to firewall rubber grommet)	→	A12	Electrical center	5.5
	Right turn signal light connector sleeve	→	A82	EDW control unit	1.4
		→	A93	Trailer socket control unit	2.B
		→	E26H3	Right front turn signal lamp	6
		→	E68h4	Right rear turn signal lamp	5
		→	H2	Right front side turn signal lamp (5 W)	1
		→	H9	Right front side turn signal lamp (21 W)	1
		→	K102	Right EDW turn signal lamp relay	1
		→	P15	Instrument cluster	1.7
J81	FWH/waistrail (next to firewall rubber grommet)	→	A12	Electrical center	5.8
	Left turn signal light connector sleeve	→	A62	WSP control unit	8
		→	A82	EDW control unit	1.1
		→	A93	Trailer socket control unit	2.E
		→	E25h21	Left front turn signal lamp	6
		→	E67h22	Left rear turn signal lamp	5
		→	H5	Left front side turn signal lamp (5 W)	1
		→	H10	Left front side turn signal lamp (21 W)	1
		→	K101	Left EDW turn signal lamp relay	1
		→	P15	Instrument cluster	2.13

J89	FWH/seat frame (behind rubber grommet)	→	F41	Daytime running lamps fuse	1
	Circuit 56b connector sleeve	→	F68	Daytime running lamps fuse	1
		→	F70	D+ relay fuse (15 A)	1
		→	K26	Circuit D+ relay	5
J277	FWH/waistrail (behind instrument cluster)	→	A12	Electrical center	5.1
	Circuit 15 connector sleeve	→	B127	Stop light switch 6-pin	1.2 2.1
		→	P17	Diagnostic socket 16-pin	8
J340	FWH/waistrail (next to firewall rubber grommet)	→	A2	ABS/ESP control unit	1.24
	CAN-high connector sleeve	→	A62	WSP control unit	5
		→	J422	CAN-high connector sleeve	
		→	P15	Instrument cluster	1.18
		→	X82	Frame/waistrail connector	3
		→	X217	Frame/waistrail connector	7
J372	FWH/waistrail (next to firewall rubber grommet)	→	P15	Instrument cluster	1.4
	Diagnostic cable connector sleeve	→	P17	Diagnostic socket 16-pin	15
		→	X82	Frame/waistrail connector	2
		→	X165	Warm water auxiliary heater connector, 8-pin	5
J378	FWH/waistrail (next to firewall rubber grommet)	→	A2	ABS/ESP control unit	1.40
	CAN-low connector sleeve	→	A62	WSP control unit	6
		→	J421	CAN-low connector sleeve	
		→	P15	Instrument cluster	1.17
		→	X82	Frame/waistrail connector	4
		→	X217	Frame/waistrail connector	8
J394	FWH/waistrail (next to firewall rubber grommet)	→	P15	Instrument cluster	2.9
	Vehicle speed signal connector sleeve	→	X79	Frame/waistrail connector	6
J415	FWH/waistrail (next to firewall rubber grommet)	→	F11	Instrument cluster fuse (7.5 A)	2

	Circuit 30 connector sleeve	→	P15	Instrument cluster	2.3
		→	P17	Diagnostic socket 16-pin	16
J446	FWH/waistrail (next to firewall rubber grommet)	→	E25	Left headlamp	1
	Circuit 58 connector sleeve	→	E26	Right headlamp	1
		→	J33	Circuit 58 connector sleeve	
		→	J144	Side marker light connector sleeve	
		→	J145	Side marker light connector sleeve	
		→	K140	Daytime running lamps circuit 58 relay	3 5
		→	P15	Instrument cluster	2.7
		→	X26	Left rear license plate lighting contact plate 2-pin	1
		→	X45	Frame/roof connector (standard)	3 4

PE83.20-D-2000-99E

[Display in a separate window](#)

To display wiring diagrams, you need a
JAVA 1.1 capable Browser like e.g. "Microsoft Internet Explorer 4.0"
or
"Netscape Navigator 4.05" and higher with AWT 1.1 support

A12	Electrical center
A81	Air conditioning pushbutton control module
A81	Air conditioning pushbutton control module
A81	Air conditioning pushbutton control module
A81s2	Blower thumbwheel switch
E90	Auxiliary warm water heater control module
E90	Auxiliary warm water heater control module
F70	D+ relay fuse (15 A)
F98	Warm water heater blower stage 1 fuse (10 A)
J16	Circuit 30 connector sleeve
J16	Circuit 30 connector sleeve
J19	Circuit 61 connector sleeve
J46	Terminal 58 connector sleeve
J89	Circuit 56b connector sleeve
J105	Terminal 15 connector sleeve
J337	ATA 2 blower stage connector sleeve
K26	Circuit D+ relay
K75	Fan stage 1 warm water heater relay
M4	Front blower LHD
M4x1	Front blower connector LHD
P15	Instrument cluster
R10	Blower stages 1-3

	series resistor
W4	Ground point firewall
W5	Ground point seat frame
W5	Ground point seat frame
W5	Ground point seat frame
W8	Ground point (waistrail)
X79	Frame/waistrail connector
X82	Frame/waistrail connector
X82	Frame/waistrail connector
X165	Warm water auxiliary heater connector, 8-pin
X165	Warm water auxiliary heater connector, 8-pin
X194	ATA 2 connector
X206	Heater connector
X206	Heater connector
Y95	Recirculated air solenoid valve

PE83.20-D-2000-60E	Legend of wiring diagram heater	Models YD1##, YD2##, YD3##, YD4##, YD5##, WD1##, WD2##, WD3## ### to 365850 up to 18.1.02 Models 903.66# /67#, 904.66# ## to 365850 up to 18.1.02 with CODE (ZU8) USA national version	
--------------------	---------------------------------	--	--

Code	Designation	Coordinate
A12	Electrical center	19L
A81	Air conditioning pushbutton control and operating unit	12A 20A 26A
A81s2	Blower thumbwheel switch	9A
E90	Warm water additional heater control unit	2L 23L
F70	D+ relay fuse (15 A)	29E
F98	Warm water heater stage 1 blower fuse (10 A)	2E
J16	Circuit 30 connector sleeve	2G 31G
J19	Circuit 61 connector sleeve	28E
J46	Circuit 58 connector sleeve	19E
J89	Circuit 56b connector sleeve	29G
J105	Circuit 15 connector sleeve	12E
J337	ATA [EDW] blower stage connector sleeve	4E
K26	Circuit D+ relay	30L
K75	Fan stage 1 warm water heater relay	3A
M4	Front end blower LHS	14L
M4x1	Front blower connector LHS	15H
P15	Instrument cluster	27L
R10	Blower stages 1-3 series resistor	11L
W4	Firewall ground point	15E
W5	Seat frame ground point	3E 28G 30G
W8	Ground point waistrail	13E

X79	Frame/waistrail connector	26E
X82	Frame/waistrail connector	6E 21E
X165	Warm water additional heater connector 8-pin	3H 21H
X194	ATA [EDW] connector	5K
X206	Heater connector	7E 16E
Y95	Recirculated air solenoid valve	17L

GF00.19-D-3100-45C	Arrangement and assignment of terminal block connectors heating	<p>Models XD1, XD2, XD3, XD4, XD5, XD6, XD7, YD1, YD2, YD3, YD4, YD5, YD6, YD7, WD1, WD2, WD3, WD6, WD7</p> <p>Models 903.61/66/67, 904.61/66 with code (ZU7) National version for Canada</p> <p>Models 903.61/66/67, 904.61/66 with code (ZU8) National version for USA</p> <p>Models 903.61/62/66/67, 904.61/62/66 with code (ZU9) National version for Mexico</p>	
--------------------	---	--	--

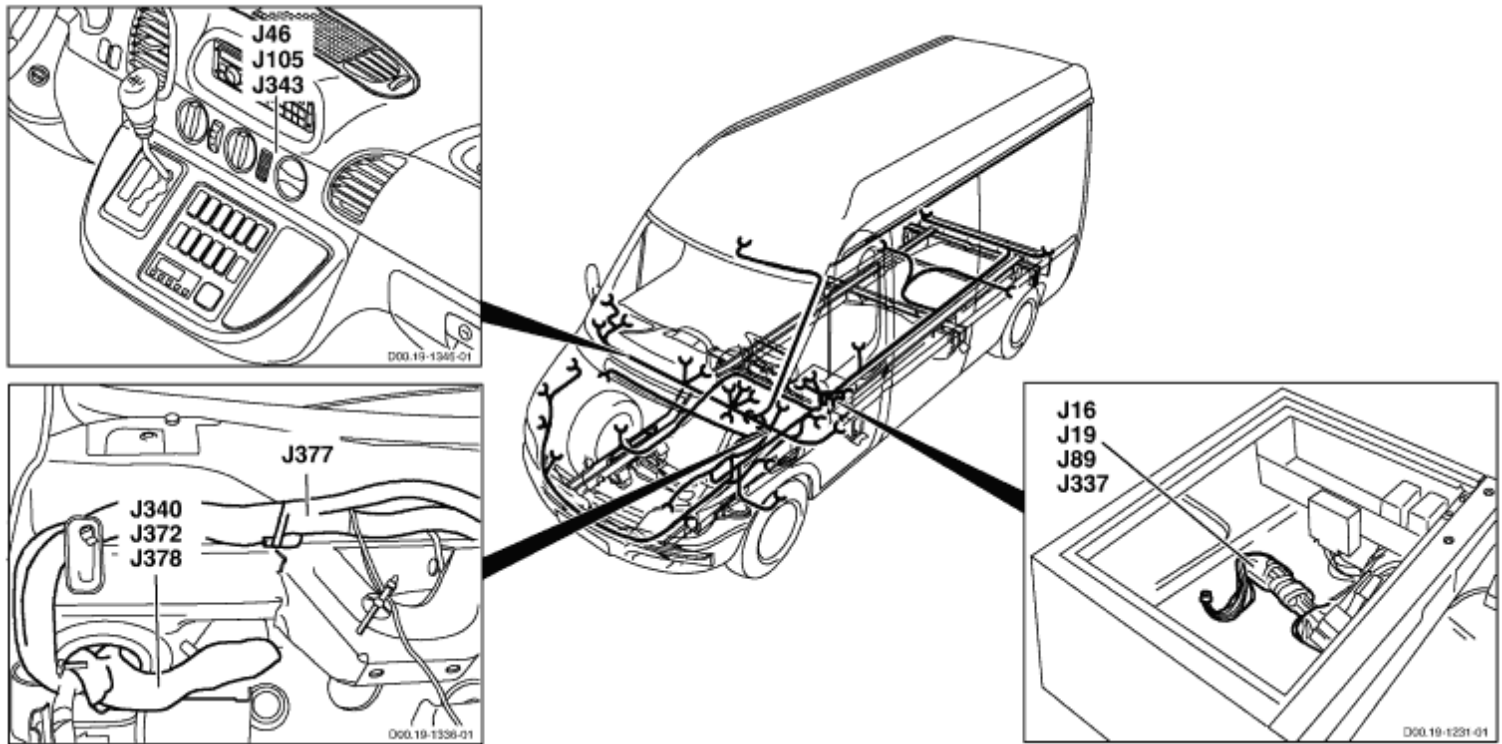

D00.19-1384-09

Terminal block	Designation		Component	Designation	Connector Pin
J16	FWH/seat frame (behind rubber grommet)	→	F6	ABS circuit 30 fuse	1
	Circuit 30 connector sleeve	→	F7	ABS circuit 30 fuse	1

		→	F9	Additional heater fuse (25 A)	1
		→	F11	Instrument cluster fuse (7.5 A)	1
		→	F40	Daytime running lamps fuse	1
		→	F43	Radio remote control fuse (10 A)	1
		→	F44	Central locking fuse (25 A)	1
		→	F62	Interior light fuse (15 A)	1
		→	F63	Heated rear window fuse (30 A)	1
		→	F98	Warm water heater stage 1 blower fuse (10 A)	1
		→	F101	Warm air additional heater fuse (7.5 A)	1
		→	F114	Additional heat exchanger fuse (25 A)	1
		→	F119	Air conditioning additional fan fuse (30 A)	1
		→	F138	Circuit 15 fuse (10 A)	1
		→	F140.3	Circuit 30 fuse (125 A)	2
		→	F143	Additional heater fuse (25 A)	1
		→	F148	Daytime running lamps relay fuse (10 A)	1
		→	F149	Roof AC fuse (40 A)	1
		→	F151	Fog lamp fuse (7.5 A)	1
		→	F153	Trailer socket fuse (25 A)	1
		→	F154	Instrument panel socket fuse (15 A)	1
		→	J327	Circuit 30 unfused connector sleeve	
		→	K26	Circuit D+ relay	1
J19	FWH/seat frame (behind rubber grommet)	→	A8	Central locking control module	1.8
	Circuit 61 connector sleeve	→	F66	Additional battery isolating relay fuse (15 A)	1
		→	F70	D+ relay fuse (15 A)	2
		→	K3	Heated rear window relay	4
		→	K78	Circuit D+ body manufacturer relay	4
		→	K135	Daytime running lamps terminal 58L relay	2
		→	K136	Daytime running lamps terminal 58R relay	2

		→	K140	Daytime running lamps circuit 58 relay	2
		→	X82	Frame/waistrail connector	13
J46	WWH (middle of instrument panel)	→	A9	Radio	1.A6
	Circuit 58 connector sleeve	→	A40	EWM control unit	2
		→	A71	Heater timer	1
		→	A81	Air conditioning pushbutton control and operating unit	1.9
		→	E104	Ashtray lighting	1
		→	S12	Driver seat heater switch	1
		→	S25	Headlamp range adjustment switch	9
		→	S48	ASR switch	1
		→	S57	Differential lock switch	1
		→	S81	Rear window defroster pushbutton	1
		→	S85	Driver interior lighting pushbutton	1
		→	S87	Auxiliary heater switch	1
		→	S90	Roof fan switch	1
		→	S92	Panic alarm button	1
		→	S99	ATA [EDW] towing/interior motion sensor button	1
		→	S100	Additional heat exchanger double-contact pushbutton	1
		→	S107	Front passenger seat heater switch	1
		→	S119.1	Fog light switch	1
		→	S124	Reading lamp switch	1
		→	S126	Interior pushbutton	1
		→	S137	Roof AC switch	1
		→	S138	Temperature switch	9
		→	X79	Frame/waistrail connector	2
		→	X234	Cigar lighter illumination plug connection	3
J89	FWH/seat frame (behind rubber grommet)	→	F41	Daytime running lamps fuse	1
	Circuit 56b connector sleeve	→	F68	Daytime running lamps fuse	1
		→	F70	D+ relay fuse (15 A)	1
		→			

			K26	Circuit D+ relay	5
J105	WWH (middle of instrument panel)	→	A71	Heater timer	10
	Circuit 15 connector sleeve	→	A81	Air conditioning pushbutton control and operating unit	1.21
		→	S48	ASR switch	7
		→	S100	Additional heat exchanger double-contact pushbutton	3 8
		→	X79	Frame/waistrail connector	1
J337	FWH/seat frame (behind rubber grommet)	→	A82	EDW control unit	1.5
	ATA [EDW] blower stage connector sleeve	→	K75	Warm water auxiliary heater fan stage 1 relay	5
		→	X82	Frame/waistrail connector	14
		→	X194	ATA [EDW] connector	8
J340	FWH/waistrail (next to firewall rubber grommet)	→	A2	ABS/ESP control unit	1.24
	CAN-high connector sleeve	→	A62	WSP control unit	5
		→	J422	CAN-high connector sleeve	
		→	P15	Instrument cluster	1.18
		→	X82	Frame/waistrail connector	3
		→	X217	Frame/waistrail connector	7
J343	WWH (middle of instrument panel)	→	A81	Air conditioning pushbutton control and operating unit	1.18
	Sensor ground connector sleeve	→	B28	Air outlet temperature sensor	2
		→	B29	Evaporator temperature sensor	2
		→	X82	Frame/waistrail connector	10
J372	FWH/waistrail (next to firewall rubber grommet)	→	P15	Instrument cluster	1.4
	Diagnostic cable connector sleeve	→	P17	Diagnostic socket 16-pin	15
		→	X82	Frame/waistrail connector	2
		→	X165	Warm water auxiliary heater connector, 8-pin	5
J377	FWH/waistrail (behind instrument cluster)	→	A12	Electrical center	4.1
	Circuit 30 connector sleeve	→	K103	Circulation pump relay	1
		→	X79	Frame/waistrail connector	3

J378	FWH/waistrail (next to firewall rubber grommet)	→	A2	ABS/ESP control unit	1.40
	CAN-low connector sleeve	→	A62	WSP control unit	6
		→	J421	CAN-low connector sleeve	
		→	P15	Instrument cluster	1.17
		→	X82	Frame/waistrail connector	4
		→	X217	Frame/waistrail connector	8

PE83.20-D-2000-99F

[Display in a separate window](#)

To display wiring diagrams, you need a
JAVA 1.1 capable Browser like e.g. "Microsoft Internet Explorer 4.0"
or
"Netscape Navigator 4.05" and higher with AWT 1.1 support

A12	Electrical center
A81	Air conditioning pushbutton control module
A81	Air conditioning pushbutton control module
A81	Air conditioning pushbutton control module
A81s2	Blower thumbwheel switch
B28	Air outlet temperature sensor
E90	Auxiliary warm water heater control module
J46	Terminal 58 connector sleeve
J105	Terminal 15 connector sleeve
J340	CAN High connector sleeve
J343	Sensor ground connector sleeve
J372	Diagnostic line connector sleeve
J377	Circuit 30 connector sleeve
J378	CAN Low connector sleeve
M4	Front blower LHD
M4x1	Front blower connector LHD
M51	Circulating pump
P17	Diagnostic socket, 16-pin
R10	Blower stages 1-3 series resistor
W4	Ground point firewall
W4	Ground point firewall
W8	Ground point (waistrail)
X79	Frame/waistrail

	connector
X82	Frame/waistrail connector
X164	Warm water auxiliary heater connector, 2-pin
X165	Warm water auxiliary heater connector, 8-pin
X206	Heater connector
Y37	Water cycle valve
Y95	Recirculated air solenoid valve

PE83.20-D-2000-60F	Legend of wiring diagram heater	Models YD1##, YD2##, YD3##, YD4##, YD5##, WD1##, WD2##, WD3## ### to 365850 up to 18.1.02 Models 903.66# /67#, 904.66# ## to 365850 up to 18.1.02 with CODE (H25) "Heizmatic" automatic heater control with CODE (ZU8) USA national version	
--------------------	---------------------------------	---	--

Code	Designation	Coordinate
A12	Electrical center	10L
A81	Air conditioning pushbutton control and operating unit	4A 12A 20A
A81s2	Blower thumbwheel switch	1A
B28	Air outlet temperature sensor	13L
E90	Warm water additional heater control unit	22L
J46	Circuit 58 connector sleeve	9E
J105	Circuit 15 connector sleeve	4E
J340	CAN-high connector sleeve	14G
J343	Sensor ground connector sleeve	13G
J372	Diagnostic cable connector sleeve	17G
J377	Circuit 30 connector sleeve	11G
J378	CAN-low connector sleeve	15G
M4	Front end blower LHS	6L
M4x1	Front blower connector LHS	6H
M51	Circulating pump	19L
P17	Diagnostic socket 16-pin	17L
R10	Blower stages 1-3 series resistor	3L
W4	Firewall ground point	7E 19G
W8	Ground point waistrail	5E
X79	Frame/waistrail connector	11E
X82	Frame/waistrail connector	14E

X164	Warm water additional heater connector 2-pin	20H
X165	Warm water additional heater connector 8-pin	21H
X206	Heater connector	8E
Y37	Water cycle valve	18L
Y95	Recirculated air solenoid valve	8L

PE83.20-D-2000-99G

[Display in a separate window](#)

To display wiring diagrams, you need a
JAVA 1.1 capable Browser like e.g. "Microsoft Internet Explorer 4.0"
or
"Netscape Navigator 4.05" and higher with AWT 1.1 support

A12	Electrical center
A81	Air conditioning pushbutton control module
A81	Air conditioning pushbutton control module
A81	Air conditioning pushbutton control module
A81s2	Blower thumbwheel switch
E90	Auxiliary warm water heater control module
E90	Auxiliary warm water heater control module
F70	D+ relay fuse (15 A)
F98	Warm water heater blower stage 1 fuse (10 A)
J16	Circuit 30 connector sleeve
J16	Circuit 30 connector sleeve
J19	Circuit 61 connector sleeve
J46	Terminal 58 connector sleeve
J89	Circuit 56b connector sleeve
J105	Terminal 15 connector sleeve
J337	ATA 2 blower stage connector sleeve
K26	Circuit D+ relay
K75	Fan stage 1 warm water heater relay
M4	Front blower LHD
M4x1	Front blower connector LHD
M4x2	Front blower connector LHD

M4x2	Front blower connector LHD
P15	Instrument cluster
R10	Blower stages 1-3 series resistor
W4	Ground point firewall
W5	Ground point seat frame
W5	Ground point seat frame
W5	Ground point seat frame
W8	Ground point (wastrail)
X79	Frame/wastrail connector
X82	Frame/wastrail connector
X82	Frame/wastrail connector
X165	Warm water auxiliary heater connector, 8-pin
X165	Warm water auxiliary heater connector, 8-pin
X194	ATA 2 connector
X206	Heater connector
X206	Heater connector
Y95	Recirculated air solenoid valve

||

PE83.20-D-2000-60G	Legend of wiring diagram heater	<p>Models XD1, XD2, XD3, XD4, XD5, XD6, XD7, YD1##, YD2##, YD3##, YD4##, YD5##, YD6##, YD7##, WD1##, WD2##, WD3##, WD6##, WD7## ### from 365851 as of 21.1.02</p> <p>Models 903.61 /66 /67, 904.61 /66 with CODE (ZU7) Canada national version</p> <p>Models 903.61# /66# /67#, 904.61# /66# ## from 365851 as of 21.1.02 with CODE (ZU8) USA national version</p> <p>Models 903.61 /62 /66 /67, 904.61 /62 /66 with CODE (ZU9) Mexico national version</p>	
--------------------	---------------------------------	---	--

Code	Designation	Coordinate
A12	Electrical center	19L
A81	Air conditioning pushbutton control and operating unit	12A 20A 25A
A81s2	Blower thumbwheel switch	9A
E90	Warm water additional heater control unit	2L 22L
F70	D+ relay fuse (15 A)	29E
F98	Warm water heater stage 1 blower fuse (10 A)	2E
J16	Circuit 30 connector sleeve	2G 30G
J19	Circuit 61 connector sleeve	28E
J46	Circuit 58 connector sleeve	18E
J89	Circuit 56b connector sleeve	29G
J105	Circuit 15 connector sleeve	13E
J337	ATA [EDW] blower stage connector sleeve	4E
K26	Circuit D+ relay	29L
K75	Fan stage 1 warm water heater relay	3A
M4	Front end blower LHS	14L
M4x1	Front blower connector LHS	15H

M4x2	Front blower connector LHS	13H 16H
P15	Instrument cluster	26L
R10	Blower stages 1-3 series resistor	11L
W4	Firewall ground point	15E
W5	Seat frame ground point	3E 28G 30G
W8	Ground point waistrail	13E
X79	Frame/waistrail connector	25E
X82	Frame/waistrail connector	6E 21E
X165	Warm water additional heater connector 8-pin	3H 21H
X194	ATA [EDW] connector	5K
X206	Heater connector	7E 16E
Y95	Recirculated air solenoid valve	16L

PE83.20-D-2000-99H

[Display in a separate window](#)

To display wiring diagrams, you need a
JAVA 1.1 capable Browser like e.g. "Microsoft Internet Explorer 4.0"
or
"Netscape Navigator 4.05" and higher with AWT 1.1 support

A12	Electrical center
A81	Air conditioning pushbutton control module
A81	Air conditioning pushbutton control module
A81	Air conditioning pushbutton control module
A81s2	Blower thumbwheel switch
B28	Air outlet temperature sensor
E90	Auxiliary warm water heater control module
J46	Terminal 58 connector sleeve
J105	Terminal 15 connector sleeve
J343	Sensor ground connector sleeve
J372	Diagnostic line connector sleeve
J377	Circuit 30 connector sleeve
M4	Front blower LHD
M4x1	Front blower connector LHS
M4x2	Front blower connector LHS
M4x2	Front blower connector LHS
M51	Circulating pump
P17	Diagnostic socket 16-pin
R10	Blower stages 1-3 series resistor
W4	Ground point firewall
W4	Ground point firewall
W8	Ground point (waistrail)
X79	Frame/waistrail

	connector
X82	Frame/waistrail connector
X164	Warm water auxiliary heater connector, 2-pin
X165	Warm water auxiliary heater connector, 8-pin
X206	Heater connector
Y37	Water cycle valve
Y95	Recirculated air solenoid valve

PE83.20-D-2000-60H	Legend of wiring diagram heater	<p>Models XD1, XD2, XD3, XD4, XD5, XD6, XD7, YD1##, YD2##, YD3##, YD4##, YD5##, YD6##, YD7##, WD1##, WD2##, WD3##, WD6##, WD7## ### from 365851 as of 21.1.02</p> <p>Models 903.61 /66 /67, 904.61 /66 with CODE (ZU7) Canada national version</p> <p>Models 903.61# /66# /67#, 904.61# /66# ## from 365851 as of 21.1.02 with CODE (ZU8) USA national version</p> <p>Models 903.61 /62 /66 /67, 904.61 /62 /66 with CODE (ZU9) Mexico national version</p>	
--------------------	---------------------------------	---	--

Code	Designation	Coordinate
A12	Electrical center	10L
A81	Air conditioning pushbutton control and operating unit	4A 12A 20A
A81s2	Blower thumbwheel switch	1A
B28	Air outlet temperature sensor	13L
E90	Warm water additional heater control unit	22L
J46	Circuit 58 connector sleeve	9E
J105	Circuit 15 connector sleeve	4E
J343	Sensor ground connector sleeve	13G
J372	Diagnostic cable connector sleeve	17G
J377	Circuit 30 connector sleeve	11G
M4	Front end blower LHS	6L
M4x1	Front blower connector LHS	7H
M4x2	Front blower connector LHS	5H 8H
M51	Circulating pump	19L
P17	Diagnostic socket 16-pin	17L
R10	Blower stages 1-3 series resistor	2L
W4	Firewall ground point	7E

		19G
W8	Ground point waistrail	6E
X79	Frame/waistrail connector	11E
X82	Frame/waistrail connector	14E
X164	Warm water additional heater connector 2-pin	20H
X165	Warm water additional heater connector 8-pin	21H
X206	Heater connector	8E
Y37	Water cycle valve	18L
Y95	Recirculated air solenoid valve	8L

PE82.20-D-2000-99L

[Display in a separate window](#)

To display wiring diagrams, you need a
JAVA 1.1 capable Browser like e.g. "Microsoft Internet Explorer 4.0"
or
"Netscape Navigator 4.05" and higher with AWT 1.1 support

A12	Electrical center
A12f8	Interior lights, radio circuit 30 fuse
E17.1	Cigar lighter
E17.2	Cigar lighter illumination
E43	Cab lamp
E69	Left side interior light
E70	Right side interior lamp
E71	Rear interior lamp
E73	Rear center interior lamp
E74	Front center interior lamp
E89	Rear interior lamp
E104	Ashtray illumination
J3	Interior light connector sleeve
J6	Circuit 30, fused, connector sleeve
J46	Terminal 58 connector sleeve
J58	Circuit 30 connector sleeve
J77	Interior light connector sleeve
J77	Interior light connector sleeve
J77	Interior light connector sleeve
J77	Interior light connector sleeve
J78	Interior light connector sleeve
J78	Interior light connector sleeve
J78	Interior light connector sleeve
J78	Interior light connector sleeve
J78	Interior light connector sleeve
J78	Interior light connector sleeve
J147	Turn signal lamps

	ground connector sleeve
J147	Turn signal lamps ground connector sleeve
J147	Turn signal lamps ground connector sleeve
J358	Tml. 31 connector sleeve
J358	Tml. 31 connector sleeve
J358	Tml. 31 connector sleeve
J358	Tml. 31 connector sleeve
S42	Left door contact switch
S43	Right door contact switch
S114	Left sliding door contact switch
S115	Right sliding door contact switch
S116	Rear door contact switch
W4	Ground point firewall
W8	Ground point (wastrail)
X45	Frame/roof connector (standard)
X79	Frame/wastrail connector
X234	Cigar lighter illumination plug connection



PE82.20-D-2000-60L	Legend for wiring diagram of interior lights	<p>Model XD1, XD2, XD3, XD4, XD5, XD6, XD7, YD1, YD2, YD3, YD4, YD5, YD6, YD7, WD1, WD2, WD3, WD6, WD7</p> <p>Models 903.61 /66 /67, 904.61 /66 with CODE (ZU7) Canada national version</p> <p>Models 903.61 /66 /67, 904.61 /66 with CODE (ZU8) USA national version</p> <p>Models 903.61 /62 /66 /67, 904.61 /62 /66 with CODE (ZU9) Mexico national version</p>	
--------------------	--	--	--

Code	Designation	Coordinate
A12	Electrical center	19A
A12f8	Interior lights, radio circuit 30 fuse	19B
E17.1	Cigarette lighter	21L
E17.2	Cigar lighter illumination	23L
E43	Cab lamp	2A
E69	Left side interior lamp	5L
E70	Right side interior lamp	7A
E71	Rear interior lamp	10A
E73	Middle interior lamp, rear	13A
E74	Middle interior lamp, front	16A
E89	Rear interior lamp	4A
E104	Ashtray lighting	22A
J3	Interior light connector sleeve	1G
J6	Circuit 30 fused connector sleeve	19E
J46	Circuit 58 connector sleeve	23E
J58	Circuit 30 connector sleeve	19G
J77	Interior light connector sleeve	4E 10E 12E 16E
J78	Interior light connector sleeve	2E

		5E 9E 11E 17E
J147	Turn signal ground connector sleeve	8E 10E 14E
J358	Tml. 31 connector sleeve	1E 7E 13E 15E
S42	Left door contact switch	1L
S43	Right door contact switch	3L
S114	Left sliding door contact switch	13L
S115	Right sliding door contact switch	14L
S116	Rear door contact switch	7L
W4	Firewall ground point	16L
W8	Ground point waistrail	22E
X45	Frame/roof connector (standard)	15H
X79	Frame/waistrail connector	19E
X234	Cigar lighter illumination plug connection	20H

GF00.19-D-3100-40D

Arrangement and assignment of terminal block connectors interior lights

Models XD1, XD2, XD3, XD4, XD5, XD6, XD7, YD1, YD2, YD3, YD4, YD5, YD6, YD7, WD1, WD2, WD3, WD6, WD7
Models 903.61/66/67, 904.61/66
with code (ZU7) National version for Canada
Models 903.61/66/67, 904.61/66
with code (ZU8) National version for USA
Models 903.61/62/66/67, 904.61/62/66
with code (ZU9) National version for Mexico

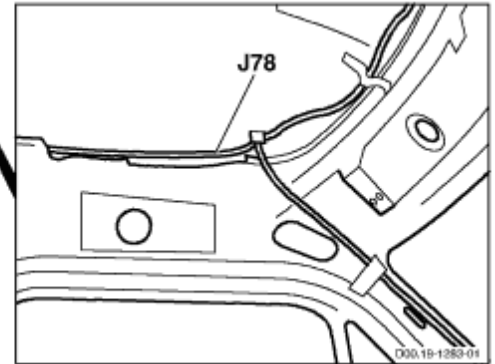
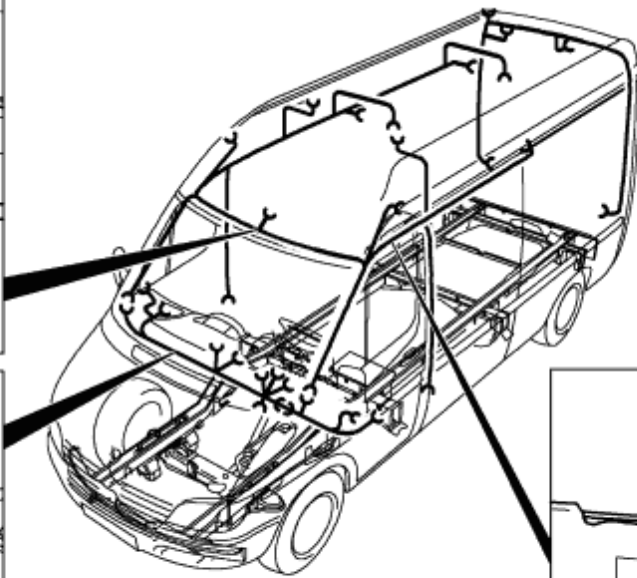
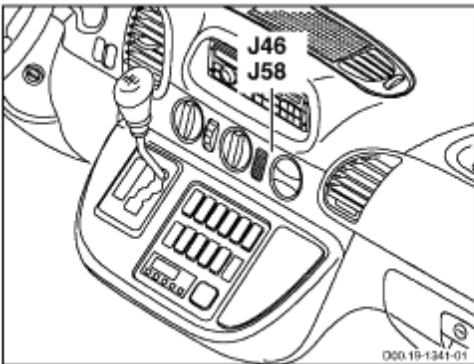
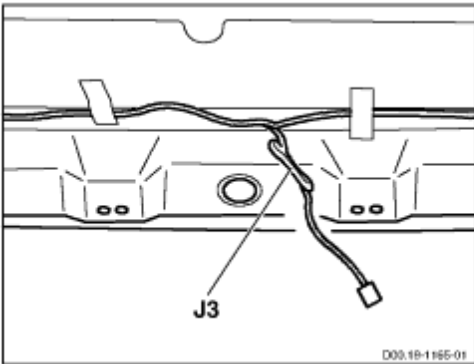

D00.19-1379-09

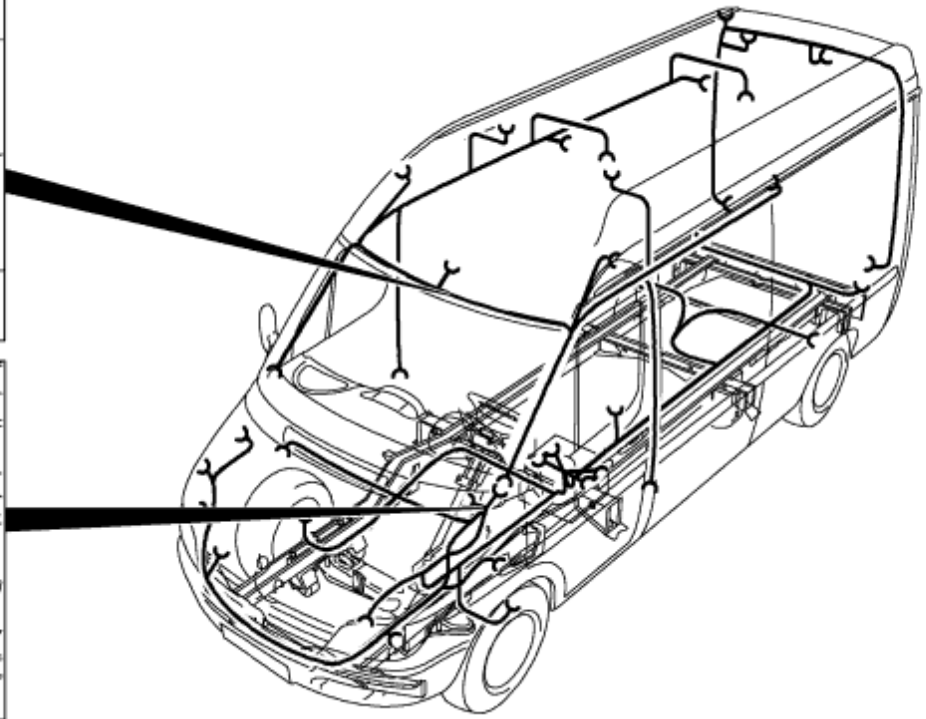
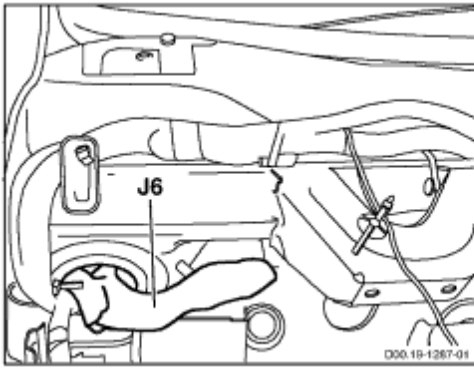
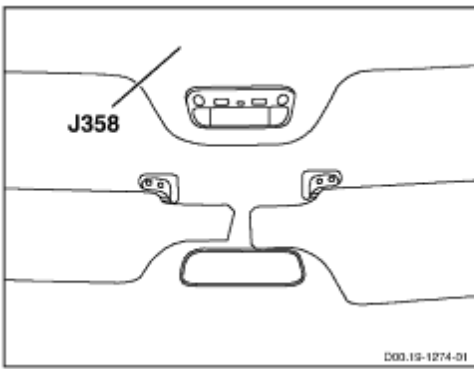

D00.19-1380-09

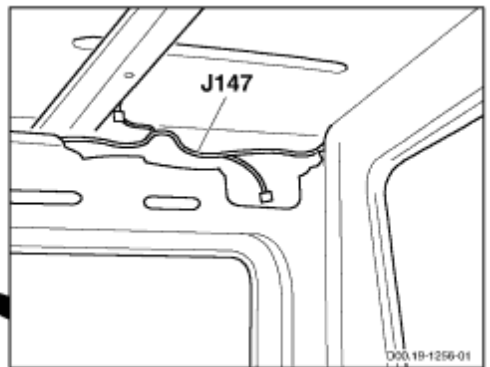
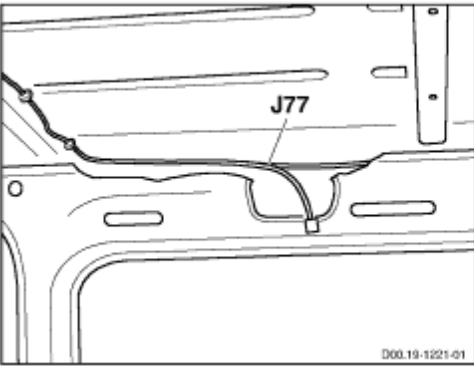

D00.19-1286-09

Terminal block	Designation		Component	Designation	Connector Pin
J3	RWH (close to E43)	→	E31	Driver entry lamp	2

	Interior light connector sleeve	→	E32	Front passenger entry lamp	2
		→	E43	Cab lamp	3
		→	S42	Left door contact switch	
		→	S43	Right door contact switch	
		→	X45	Frame/roof connector (standard)	5
		→	X193	Frame/roof connector	2
J6	FWH/waistrail (next to firewall rubber grommet)	→	A12	Electrical center	4.11
	Circuit 30 fused connector sleeve	→	K101	Left EDW turn signal lamp relay	5
		→	K102	Right EDW turn signal lamp relay	5
		→	X45	Frame/roof connector (standard)	1
		→	X79	Frame/waistrail connector	8
J46	WWH (middle of instrument panel)	→	A9	Radio	1.A6
	Circuit 58 connector sleeve	→	A40	EWM control unit	2
		→	A71	Heater timer	1
		→	A81	Air conditioning pushbutton control and operating unit	1.9
		→	E104	Ashtray lighting	1
		→	S12	Driver seat heater switch	1
		→	S25	Headlamp range adjustment switch	9
		→	S48	ASR switch	1
		→	S57	Differential lock switch	1
		→	S81	Rear window defroster pushbutton	1
		→	S85	Driver interior lighting pushbutton	1
		→	S87	Auxiliary heater switch	1
		→	S90	Roof fan switch	1
		→	S92	Panic alarm button	1
		→	S99	ATA [EDW] towing/interior motion sensor button	1
		→	S100	Additional heat exchanger double-contact pushbutton	1
		→	S107	Front passenger seat heater switch	1
		→	S119.1	Fog light switch	1
		→	S124	Reading lamp switch	1
		→	S126	Interior pushbutton	1

		→	S137	Roof AC switch	1
		→	S138	Temperature switch	9
		→	X79	Frame/waistrail connector	2
		→	X234	Cigar lighter illumination plug connection	3
J58	WWH (middle of instrument panel)	→	A9	Radio	1.A4
	Circuit 30 connector sleeve	→	S87	Auxiliary heater switch	3
		→	X79	Frame/waistrail connector	8
		→	X234	Cigar lighter illumination plug connection	1
J77	RWH (close to interior light E70)	→	E69	Left side interior lamp	3
	Interior light connector sleeve	→	E70	Right side interior lamp	3
		→	E71	Rear interior lamp	3
		→	E73	Middle interior lamp, rear	3
		→	E74	Middle interior lamp, front	3
		→	E89	Rear interior lamp	2
		→	E98	Right sliding door entry lamp	2
		→	E99	Left sliding door entry lamp	2
		→	S114	Left sliding door contact switch	
		→	S115	Right sliding door contact switch	
		→	S116	Rear door contact switch	
		→	X193	Frame/roof connector	1
J78	RWH (close to left front body-outline light)	→	E31	Driver entry light	1
	Interior light connector sleeve	→	E32	Front passenger entry lamp	1
		→	E43	Cab lamp	2
		→	E69	Left side interior lamp	2
		→	E70	Right side interior lamp	2
		→	E71	Rear interior lamp	2
		→	E73	Middle interior lamp, rear	2
		→	E74	Middle interior lamp, front	2
		→	E89	Rear interior lamp	1
		→	E98	Right sliding door entry lamp	1
		→	E99	Left sliding door entry lamp	1
		→	X45	Frame/roof connector (standard)	1

J147	RWH (close to interior light E71)	→	E70	Right side interior lamp	1
	Turn signal ground connector sleeve	→	E71	Rear interior lamp	1
		→	E73	Middle interior lamp, rear	1
		→	E74	Middle interior lamp, front	1
		→	J358	Tml. 31 connector sleeve	
J358	RHW (close to interior motion sensor B104)	→	B104	Interior sensor	1
	Tml. 31 connector sleeve	→	B105	Interior sensor	1
		→	B106	Interior sensor	1
		→	E12	Additional stop light	2
		→	E38	Left front body outline lamp	2
		→	E39	Right front body outline lamp	2
		→	E43	Cab lamp	1
		→	E53	Interior light I	2
		→	E54	Interior light II	2
		→	E55	Interior light III	2
		→	E102	Interior lamp IV	2
		→	E103	Interior lamp V	2
		→	E69	Left side interior lamp	1
		→	E70	Right side interior lamp	1
		→	E73	Middle interior lamp, rear	1
		→	E74	Middle interior lamp, front	1
		→	J147	Turn signal ground connector sleeve	
		→	X45	Frame/roof connector (standard)	6
		→	X161	Reading lamp plug connection	1
		→	X171	Interior lighting connector	3

PE82.20-D-2000-99M

[Display in a separate window](#)

To display wiring diagrams, you need a
JAVA 1.1 capable Browser like e.g. "Microsoft Internet Explorer 4.0"
or
"Netscape Navigator 4.05" and higher with AWT 1.1 support

E53	Interior lamp I
E54	Interior lamp II
E55	Interior lamp III
E102	Interior light IV
E103	Interior light V
F62	Interior lights fuse (15 A)
J16	Circuit 30 connector sleeve
J46	Terminal 58 connector sleeve
J289	Interior lighting voltage supply connector sleeve
J290	Interior lighting stepping relay connector sleeve
J290	Interior lighting stepping relay connector sleeve
J291	Interior lighting pushbutton connector sleeve
J291	Interior lighting pushbutton connector sleeve
J292	Interior lighting circuit 30 connector sleeve
J292	Interior lighting circuit 30 connector sleeve
J292	Interior lighting circuit 30 connector sleeve
J358	Tml. 31 connector sleeve
J358	Tml. 31 connector sleeve
J436	Cargo area fan time relay connector sleeve
J436	Cargo area fan time relay connector sleeve
J449	Interior lighting

	pushbutton plug connection connector sleeve
J450	Interior lighting plug connection connector sleeve
J452	Interior lighting stepping relay connector sleeve
K54	Interior lights stepping relay
S85	Driver interior light pushbutton
S86	Rear interior lighting pushbutton
S124	Reading lamp switch
S158	Right interior lighting pushbutton
S165	Left interior lighting pushbutton
W4	Ground point firewall
W5	Ground point seat frame
W8	Ground point (wastrail)
W8	Ground point (wastrail)
X45	Frame/roof connector (standard)
X128	Frame/wastrail connector
X128	Frame/wastrail connector
X133	Interior lighting stepping relay plug connection
X133	Interior lighting stepping relay plug connection
X133	Interior lighting stepping relay plug connection
X133	Interior lighting stepping relay plug connection
X161	Reading lamp connector

X169 Reading lamp
connector

X171 Interior lighting plug
connection

PE82.20-D-2000-60M	Legend of wiring diagram for interior lights	<p>MODEL YD1##, YD2##, YD3##, YD4##, YD5##, YD6##, YD7##, WD1##, WD2##, WD3##, WD6##, WD7## ### up to 605787 up to 28.11.03</p> <p>MODEL 903.61# /66# /67#, 904.61# /66# ## up to 605787 up to 28.11.03 with CODE (L63) dome lamp for load compartment with CODE (ZU7) National version for Canada</p> <p>MODEL 903.61# /66# /67#, 904.61# /66# ## up to 605787 up to 28.11.03 with CODE (L63) dome lamp for load compartment with CODE (ZU8) National version for USA</p> <p>MODEL 903.61# /66# /67#, 904.61# /66# ## up to 605787 up to 28.11.03 with CODE (L63) dome lamp for load compartment with CODE (ZU9) National version for Mexico</p>	
--------------------	--	---	--

Code	Designation	Coordinate
E53	Interior light I	4L
E54	Interior light II	6L
E55	Interior light III	7L
E102	Interior lamp IV	9L
E103	Interior lamp V	10L
F62	Interior light fuse (15 A)	19G
J16	Circuit 30 connector sleeve	19L
J46	Circuit 58 connector sleeve	3E
J289	Interior lighting voltage supply connector sleeve	6G
J290	Interior lighting stepping relay connector sleeve	10E 14A
J291	Interior lighting pushbutton connector sleeve	9E 21L
J292	Interior illumination circuit 30 connector sleeve	1E

		8E 13A
J358	Circuit. 31 connector sleeve	3G 8G
J436	Cargo area fan time relay connector sleeve	11E 18L
J449	Interior illumination button plug connection connector sleeve	18E
J450	Interior lighting plug connection connector sleeve	18E
J452	Interior lighting stepping relay connector sleeve	9G
K54	Interior lighting stepping relay	10A
S85	Driver interior lighting pushbutton	6A
S86	Rear interior lighting pushbutton	16A
S124	Reading lamp switch	2A
S158	Right interior lighting pushbutton	19A
S165	Left interior lighting button	22A
W4	Firewall ground point	1L
W5	Seat frame ground point	10E
W8	Waistrail ground point	3E 5E
X45	Frame/roof connector (standard)	1G
X128	Frame/waistrail connector	6E 12E
X133	Interior lighting stepping relay connector	12H 14E 17H 20H
X161	Reading lamp connector	2L
X169	Reading lamp connector	2E
X171	Interior lighting connector	13L

GF00.19-D-3100-40G

Arrangement and assignment of terminal block connectors interior lights

Models YD1, YD2, YD3, YD4, YD5, YD6, YD7, WD1, WD2, WD3, WD6, WD7
Models 903.61/66/67, 904.61/66
with code (L63) Load compartment dome lamp
with code (ZU7) National version for Canada
Models 903.61/66/67, 904.61/66
with code (L63) Load compartment dome lamp
with code (ZU8) National version for USA
Models 903.61/66/67, 904.61/66
with code (L63) Load compartment dome lamp
with code (ZU9) National version for Mexico

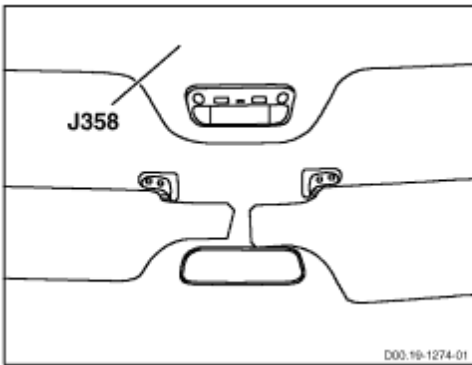

D00.19-1274-01

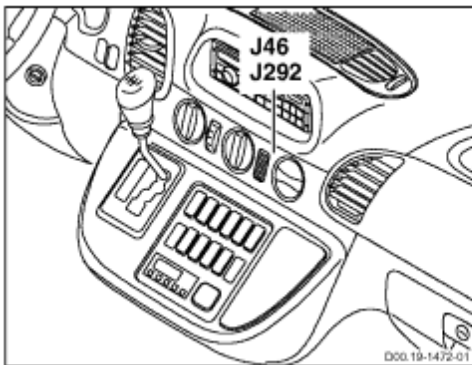

D00.19-1472-01

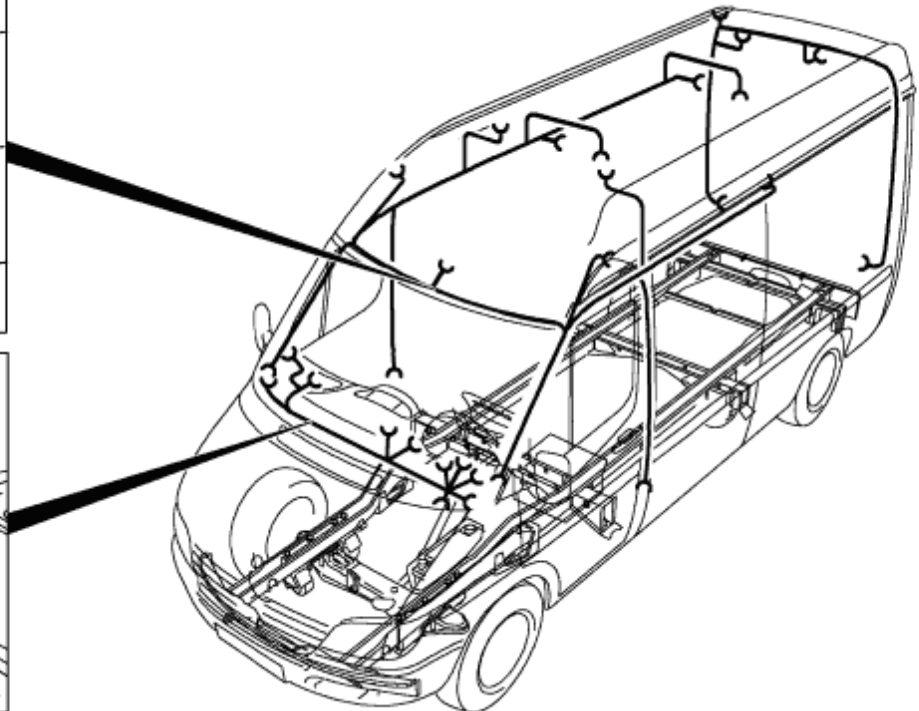

D00.19-1471-09

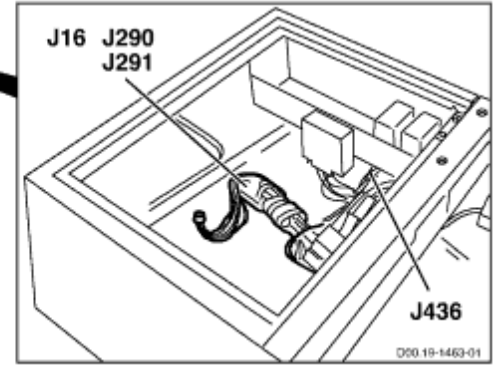
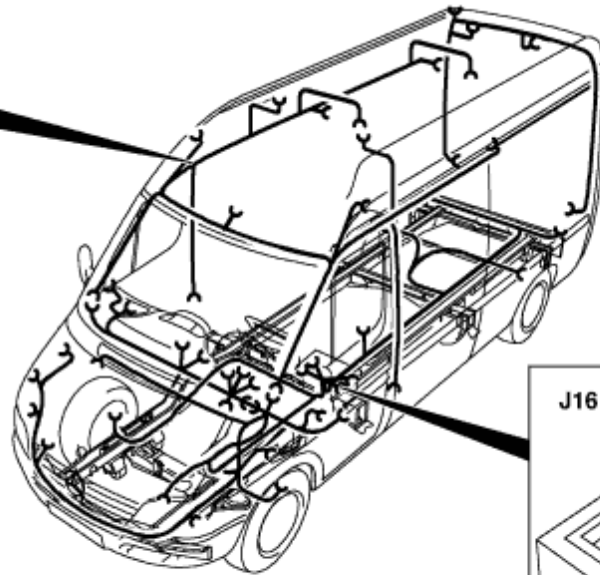
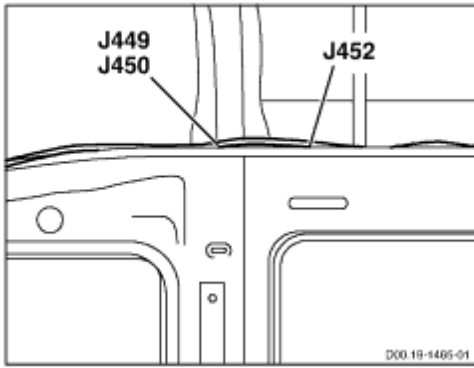

D00.19-1464-09

Terminal block	Designation		Component	Designation	Connector Pin
J16	FWH/seat frame (behind rubber grommet)	→	F6	ABS circuit 30 fuse	1
	Circuit 30 connector sleeve	→	F7	ABS circuit 30 fuse	1
		→	F9	Additional heater fuse (25 A)	1
		→	F11	Instrument cluster fuse (7.5 A)	1
		→	F40	Daytime running lamps fuse	1
		→	F43	Radio remote control fuse (10 A)	1
		→	F44	Central locking fuse (25 A)	1
		→	F62	Interior light fuse (15 A)	1
		→	F63	Heated rear window fuse (30 A)	1
		→	F98	Warm water heater stage 1 blower fuse (10 A)	1
		→	F101	Warm air additional heater fuse (7.5 A)	1
		→	F114	Additional heat exchanger fuse (25 A)	1
		→	F119	Air conditioning additional fan fuse (30 A)	1

		→	F138	Circuit 15 fuse (10 A)	1
		→	F140.3	Circuit 30 fuse (125 A)	2
		→	F143	Additional heater fuse (25 A)	1
		→	F148	Daytime running lamps relay fuse (10 A)	1
		→	F149	Roof AC fuse (40 A)	1
		→	F151	Fog lamp fuse (7.5 A)	1
		→	F153	Trailer socket fuse (25 A)	1
		→	F154	Instrument panel socket fuse (15 A)	1
		→	J327	Circuit 30 unfused connector sleeve	
		→	K26	Circuit D+ relay	1
J46	WWH (middle of instrument panel)	→	A9	Car radio	1.A6
	Circuit 58 connector sleeve	→	A40	EWM control unit	2
		→	A71	Heater timer	1
		→	A81	Air conditioning pushbutton control and operating unit	1.9
		→	E104	Ashtray lighting	1
		→	S12	Driver seat heater switch	1
		→	S25	Headlamp range adjustment switch	9
		→	S48	ASR switch	1
		→	S57	Differential lock switch	1
		→	S81	Rear window defroster pushbutton	1
		→	S85	Driver interior lighting pushbutton	1
		→	S87	Auxiliary heater switch	1
		→	S90	Roof fan switch	1
		→	S92	Panic alarm button	1
		→	S99	ATA [EDW] towing/interior motion sensor button	1
		→	S100	Additional heat exchanger double-contact pushbutton	1
		→	S107	Front passenger seat heater switch	1
		→	S119.1	Fog light switch	1
		→	S124	Reading lamp switch	1
		→	S126	Interior pushbutton	1
		→	S137	Roof AC switch	1

		→	S138	Temperature switch	9
		→	X79	Frame/waistrail connector	2
		→	X234	Cigar lighter illumination plug connection	3
J290	FWH/seat frame (behind rubber grommet)	→	K54	Interior lighting stepping relay	15
	Interior light connector sleeve	→	X128	Frame/waistrail connector	11
		→	X133	Interior lighting stepping relay connector	3
J291	FWH/seat frame (behind rubber grommet)	→	K54	Interior lighting stepping relay	13
	Interior light connector sleeve	→	X128	Frame/waistrail connector	12
		→	X133	Interior lighting stepping relay connector	2 4
J292	WWH (middle of instrument panel)	→	S85	Driver interior lighting pushbutton	3
	Circuit 15 connector sleeve	→	S124	Reading lamp switch	3
		→	X128	Frame/waistrail connector	17
J358	RHW (close to interior motion sensor B104)	→	B104	Interior sensor	1
	Tml. 31 connector sleeve	→	B105	Interior sensor	1
		→	B106	Interior sensor	1
		→	E12	Additional stop light	2
		→	E38	Left front body outline lamp	2
		→	E39	Right front body outline lamp	2
		→	E43	Cab lamp	1
		→	E53	Interior light I	2
		→	E54	Interior light II	2
		→	E55	Interior light III	2
		→	E102	Interior lamp IV	2
		→	E103	Interior lamp V	2
		→	E69	Left side interior lamp	1
		→	E70	Right side interior lamp	1
		→	E73	Middle interior lamp, rear	1
		→	E74	Middle interior lamp, front	1
		→	J147	Turn signal ground connector sleeve	
		→			

			X45	Frame/roof connector (standard)	6
		→	X161	Reading lamp plug connection	1
		→	X171	Interior lighting connector	3
J436	FWH/seat frame (close to K54)	→	F62	Interior light fuse (15 A)	2
	Circuit 15 connector sleeve	→	K54	Interior lighting stepping relay	1 4
		→	X128	Frame/waistrail connector	17
		→	X133	Interior lighting stepping relay connector	1
J449	RWH (close to B-pillar)	→	S86	Rear interior lighting pushbutton	3
	Interior lighting pushbutton plug connection connector sleeve	→	S158	Right interior lighting pushbutton	3
		→	S165	Left interior lighting button	3
		→	X133	Interior lighting stepping relay connector	1
J450	RWH (close to B-pillar)	→	S86	Rear interior lighting pushbutton	7
	Interior lighting plug connection connector sleeve	→	S158	Right interior lighting pushbutton	7
		→	S165	Left interior lighting button	3
		→	X133	Interior lighting stepping relay connector	2
J452	RWH (close to B-pillar)	→	E102	Interior lamp IV	1
	Interior lighting stepping relay connector sleeve	→	E103	Interior lamp V	1
		→	X133	Interior lighting stepping relay connector	3

To display wiring diagrams, you need a
JAVA 1.1 capable Browser like e.g. "Microsoft Internet Explorer 4.0"
or
"Netscape Navigator 4.05" and higher with AWT 1.1 support

E53	Interior lamp I
E54	Interior lamp II
E55	Interior lamp III
E102	Interior light IV
E103	Interior light IV
F62	Interior lights fuse (15 A)
J16	Circuit 30 connector sleeve
J46	Terminal 58 connector sleeve
J289	Interior lighting voltage supply connector sleeve
J291	Interior lighting pushbutton connector sleeve
J291	Interior lighting pushbutton connector sleeve
J292	Interior lighting circuit 30 connector sleeve
J292	Interior lighting circuit 30 connector sleeve
J292	Interior lighting circuit 30 connector sleeve
J358	Tml. 31 connector sleeve
J358	Tml. 31 connector sleeve
J436	Cargo area fan time relay connector sleeve
J436	Cargo area fan time relay connector sleeve
J449	Interior lighting pushbutton plug connection connector sleeve
J450	Interior lighting plug connection connector sleeve

J452 Interior lighting
stepping relay
connector sleeve

K54 Interior lights
stepping relay

S85 Driver interior light
pushbutton

S86 Rear interior lighting
pushbutton

S124 Reading lamp switch

S158 Right interior lighting
pushbutton

S165 Left interior lighting
pushbutton

W4 Ground point firewall

W5 Ground point seat
frame

W8 Ground point
(waistrail)

W8 Ground point
(waistrail)

X45 Frame/roof
connector (standard)

X128 Frame/waistrail
connector

X128 Frame/waistrail
connector

X133 Interior lighting
stepping relay plug
connection

X133 Interior lighting
stepping relay plug
connection

X133 Interior lighting
stepping relay plug
connection

X133 Interior lighting
stepping relay plug
connection

X161 Reading lamp
connector

X169 Reading lamp
connector

X171 Interior lighting plug
connection



PE82.20-D-2000-60N	Legend of wiring diagram for interior lights	<p>MODEL YD1##, YD2##, YD3##, YD4##, YD5##, YD6##, YD7##, WD1##, WD2##, WD3##, WD6##, WD7## ### as from 605788 as from 1.12.03</p> <p>MODEL 903.61# /66# /67#, 904.61# /66# ## as from 605788 as from 1.12.03 with CODE (L63) dome lamp for load compartment with CODE (ZU7) National version for Canada</p> <p>MODEL 903.61# /66# /67#, 904.61# /66# ## as from 605788 as from 1.12.03 with CODE (L63) dome lamp for load compartment with CODE (ZU8) National version for USA</p> <p>MODEL 903.61# /66# /67#, 904.61# /66# ## as from 605788 as from 1.12.03 with CODE (L63) dome lamp for load compartment with CODE (ZU9) National version for Mexico</p>	
--------------------	--	---	--

Code	Designation	Coordinate
E53	Interior light I	4L
E54	Interior light II	6L
E55	Interior light III	7L
E102	Interior lamp IV	8L
E103	Interior lamp V	10L
F62	Interior light fuse (15 A)	19G
J16	Circuit 30 connector sleeve	19L
J46	Circuit 58 connector sleeve	3E
J289	Interior lighting voltage supply connector sleeve	6G
J291	Interior lighting pushbutton connector sleeve	9E 20L
J292	Interior lighting circuit 30 connector sleeve	1E 8E 13A

J358	Circuit 31 connector sleeve	3G 8G
J436	Cargo area fan time relay connector sleeve	11E 18L
J449	Interior illumination button plug connection connector sleeve	18E
J450	Interior lighting plug connection connector sleeve	18E
J452	Interior lights IV and V connector sleeve	11H
K54	Interior lighting stepping relay	10A
S85	Driver interior lighting pushbutton	6A
S86	Rear interior lighting pushbutton	16A
S124	Reading lamp switch	2A
S158	Right interior lighting pushbutton	19A
S165	Left interior lighting button	22A
W4	Firewall ground point	1L
W5	Seat frame ground point	10E
W8	Waistrail ground point	3E 5E
X45	Frame/roof connector (standard)	1G
X128	Frame/waistrail connector	6E 12E
X133	Interior lighting stepping relay connector	13H 14E 17H 20H
X161	Reading lamp connector	2L
X169	Reading lamp connector	2E
X171	Interior lighting connector	14L

PE83.30-D-2001-99B

[Display in a separate window](#)

To display wiring diagrams, you need a
JAVA 1.1 capable Browser like e.g. "Microsoft Internet Explorer 4.0"
or
"Netscape Navigator 4.05" and higher with AWT 1.1 support

A12	Electrical center
A81	Air conditioning pushbutton control module
A81	Air conditioning pushbutton control module
A81	Air conditioning pushbutton control module
A81	Air conditioning pushbutton control module
A81s2	Blower thumbwheel switch
B28	Air outlet temperature sensor
B29	Evaporator temperature sensor
B56	Refrigerant pressure sensor
E90	Auxiliary warm water heater control module
F119	AC additional fan fuse (30 A)
J16	Circuit 30 connector sleeve
J46	Terminal 58 connector sleeve
J105	Terminal 15 connector sleeve
J343	Sensor ground connector sleeve
J372	Diagnostic line connector sleeve
J377	Circuit 30 connector sleeve
K77	AC additional fan relay
M4	Front blower LHD
M4x1	Front blower connector LHS
M45	Air conditioning auxiliary fan
M51	Circulating pump

P17	Diagnostic socket 16-pin
R10	Blower stages 1-3 series resistor
W2	Ground point right headlamp
W4	Ground point firewall
W4	Ground point firewall
W5	Ground point seat frame
W8	Ground point (wastrail)
X79	Frame/wastrail connector
X82	Frame/wastrail connector
X164	Warm water auxiliary heater connector, 2-pin
X165	Warm water auxiliary heater connector, 8-pin
X195	Frame/engine connector
X206	Heater connector
Y37	Water cycle valve
Y38	Air conditioning compressor clutch
Y95	Recirculated air solenoid valve



PE83.30-D-2001-60B	Legend of wiring diagram of climate control	Models yD1##, YD2##, YD3##, YD4##, YD5##, WD1##, WD2##, WD3## ### to 365850 up to 18.1.02 Models 903.66# /67#, 904.66# ## to 365850 up to 18.1.02 with CODE (HH9) "Tempmatik" regulated air conditioning with CODE (ZU8) USA national version	
--------------------	---	---	--

Code	Designation	Coordinate
A12	Electrical center	10L
A81	Air conditioning pushbutton control and operating unit	4A 12A 20A 28A
A81s2	Blower thumbwheel switch	1A
B28	Air outlet temperature sensor	13L
B29	Evaporator temperature sensor	14L
B56	Refrigerant pressure sensor	16L
E90	Warm water additional heater control unit	31L
F119	Air conditioning additional fan fuse (30 A)	27G
J16	Circuit 30 connector sleeve	27L
J46	Circuit 58 connector sleeve	10E
J105	Circuit 15 connector sleeve	4E
J343	Sensor ground connector sleeve	13G
J372	Diagnostic cable connector sleeve	20G
J377	Circuit 30 connector sleeve	11G
K77	Air conditioning additional fan relay	26L
M4	Front end blower LHS	6L
M4x1	Front blower connector LHS	6G
M45	Air conditioning additional fan	24L
M51	Circulating pump	23L
P17	Diagnostic socket 16-pin	20L
R10	Blower stages 1-3 series resistor	3L

W2	Ground point right headlamp	24G
W4	Firewall ground point	7E 22G
W5	Seat frame ground point	25G
W8	Ground point waistrail	5E
X79	Frame/waistail connector	11E
X82	Frame/waistail connector	15E
X164	Warm water additional heater connector 2-pin	30H
X165	Warm water additional heater connector 8-pin	31H
X195	Frame/engine connector	28H
X206	Heater connector	8E
Y37	Water cycle valve	21L
Y38	AC compressor clutch	28L
Y95	Recirculated air solenoid valve	8L

<p>GF00.19-D-3100-69A</p>	<p>Arrangement and assignment of climate control terminal blocks</p>	<p>Models XD1, XD2, XD3, XD4, XD5, XD6, XD7, YD1, YD2, YD3, YD4, YD5, YD6, YD7, WD1, WD2, WD3, WD6, WD7 Models 903.61/66/67, 904.61/66 with code (HH9) Regulated air conditioning, "Tempmatik" with code (ZU7) National version for Canada Models 903.61/66/67, 904.61/66 with code (HH9) Regulated air conditioning, "Tempmatik" with code (ZU8) National version for USA Models 903.61/62/66/67, 904.61/62/66 with code (HH9) Regulated air conditioning, "Tempmatik" with code (ZU9) National version for Mexico</p>	
---------------------------	--	---	--

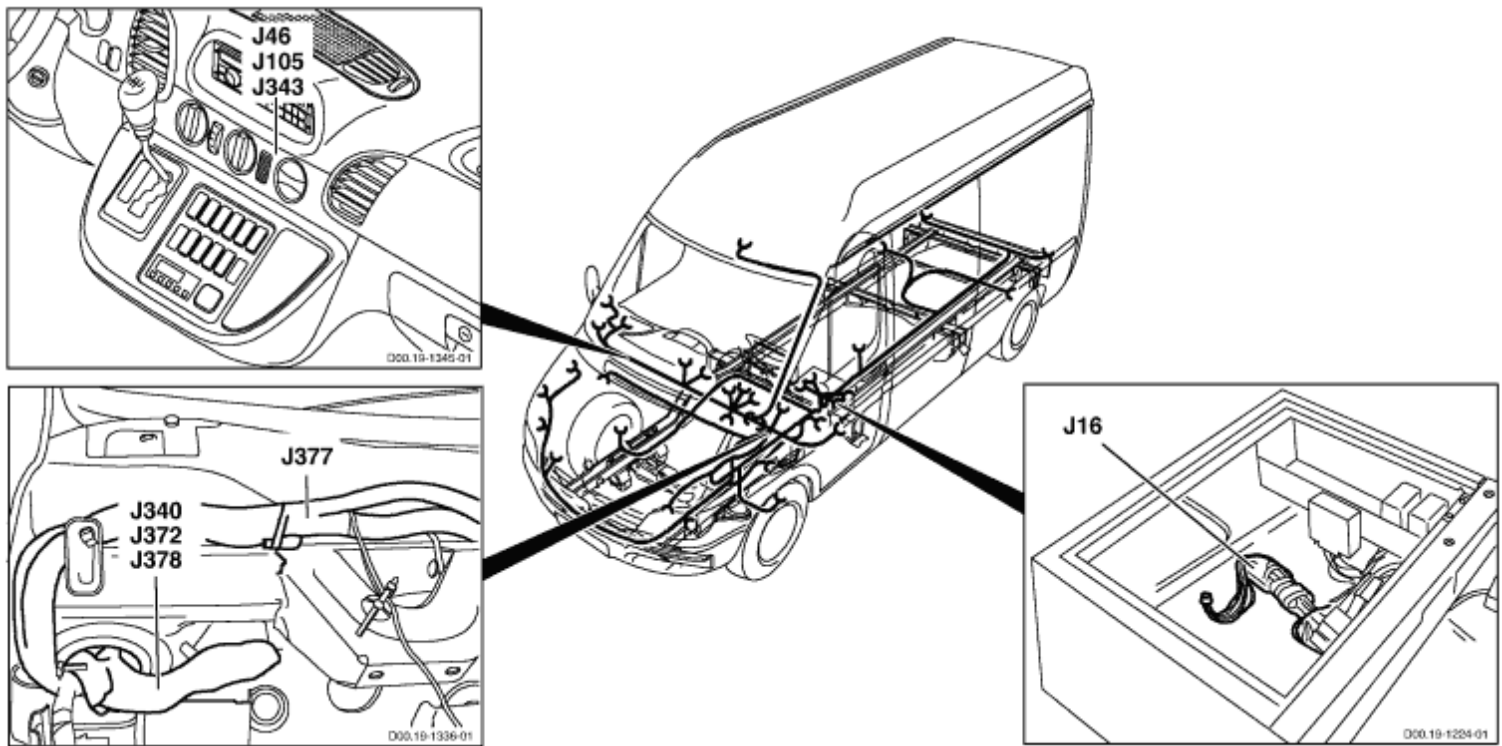

D00.19-1385-09

Terminal block	Designation	Component	Designation	Connector
----------------	-------------	-----------	-------------	-----------

					Pin
J16	FWH/seat frame (behind rubber grommet)	→	F6	ABS circuit 30 fuse	1
	Circuit 30 connector sleeve	→	F7	ABS circuit 30 fuse	1
		→	F9	Additional heater fuse (25 A)	1
		→	F11	Instrument cluster fuse (7.5 A)	1
		→	F40	Daytime running lamps fuse	1
		→	F43	Radio remote control fuse (10 A)	1
		→	F44	Central locking fuse (25 A)	1
		→	F62	Interior light fuse (15 A)	1
		→	F63	Heated rear window fuse (30 A)	1
		→	F98	Warm water heater stage 1 blower fuse (10 A)	1
		→	F101	Warm air additional heater fuse (7.5 A)	1
		→	F114	Additional heat exchanger fuse (25 A)	1
		→	F119	Air conditioning additional fan fuse (30 A)	1
		→	F138	Circuit 15 fuse (10 A)	1
		→	F140.3	Circuit 30 fuse (125 A)	2
		→	F143	Additional heater fuse (25 A)	1
		→	F148	Daytime running lamps relay fuse (10 A)	1
		→	F149	Roof AC fuse (40 A)	1
		→	F151	Fog lamp fuse (7.5 A)	1
		→	F153	Trailer socket fuse (25 A)	1
		→	F154	Instrument panel socket fuse (15 A)	1
		→	J327	Circuit 30 unfused connector sleeve	
		→	K26	Circuit D+ relay	1
J46	WWH (middle of instrument panel)	→	A9	Radio	1.A6
	Circuit 58 connector sleeve	→	A40	EWM control unit	2
		→	A71	Heater timer	1
		→	A81	Air conditioning pushbutton control and operating unit	1.9
		→	E104	Ashtray lighting	1

		→	S12	Driver seat heater switch	1
		→	S25	Headlamp range adjustment switch	9
		→	S48	ASR switch	1
		→	S57	Differential lock switch	1
		→	S81	Rear window defroster pushbutton	1
		→	S85	Driver interior lighting pushbutton	1
		→	S87	Auxiliary heater switch	1
		→	S90	Roof fan switch	1
		→	S92	Panic alarm button	1
		→	S99	ATA [EDW] towing/interior motion sensor button	1
		→	S100	Additional heat exchanger double-contact pushbutton	1
		→	S107	Front passenger seat heater switch	1
		→	S119.1	Fog light switch	1
		→	S124	Reading lamp switch	1
		→	S126	Interior pushbutton	1
		→	S137	Roof AC switch	1
		→	S138	Temperature switch	9
		→	X79	Frame/waistrail connector	2
		→	X234	Cigar lighter illumination plug connection	3
J105	WWH (middle of instrument panel)	→	A71	Heater timer	10
	Circuit 15 connector sleeve	→	A81	Air conditioning pushbutton control and operating unit	1.21
		→	S48	ASR switch	7
		→	S100	Additional heat exchanger double-contact pushbutton	3 8
		→	X79	Frame/waistrail connector	1
J340	FWH/waistrail (next to firewall rubber grommet)	→	A2	ABS/ESP control unit	1.24
	CAN-high connector sleeve	→	A62	WSP control unit	5
		→	J422	CAN-high connector sleeve	
		→	P15	Instrument cluster	1.18
		→	X82	Frame/waistrail connector	3
		→	X217	Frame/waistrail connector	7

J343	WWH (middle of instrument panel)	→	A81	Air conditioning pushbutton control and operating unit	1.18
	Sensor ground connector sleeve	→	B28	Air outlet temperature sensor	2
		→	B29	Evaporator temperature sensor	2
		→	X82	Frame/waistrail connector	10
J372	FWH/waistrail (next to firewall rubber grommet)	→	P15	Instrument cluster	1.4
	Diagnostic cable connector sleeve	→	P17	Diagnostic socket 16-pin	15
		→	X82	Frame/waistrail connector	2
		→	X165	Warm water auxiliary heater connector, 8-pin	5
J377	FWH/waistrail (behind instrument cluster)	→	A12	Electrical center	4.1
	Circuit 30 connector sleeve	→	K103	Circulation pump relay	1
		→	X79	Frame/waistrail connector	3
J378	FWH/waistrail (next to firewall rubber grommet)	→	A2	ABS/ESP control unit	1.40
	CAN-low connector sleeve	→	A62	WSP control unit	6
		→	J421	CAN-low connector sleeve	
		→	P15	Instrument cluster	1.17
		→	X82	Frame/waistrail connector	4
		→	X217	Frame/waistrail connector	8

PE83.30-D-2001-99C[Display in a separate window](#)

To display wiring diagrams, you need a
JAVA 1.1 capable Browser like e.g. "Microsoft Internet Explorer 4.0"
or
"Netscape Navigator 4.05" and higher with AWT 1.1 support

F149	Roof AC fuse (40 A)
J16	Circuit 30 connector sleeve
J19	Circuit 61 connector sleeve
J46	Terminal 58 connector sleeve
J429	Circuit 61 connector sleeve
S137	Roof AC switch
S138	Temperature switch
W8	Ground point (waistrail)
W41	Ground point roof AC
X82	Frame/waistrail connector
X220	Roof AC control unit
X220	Roof AC control unit
X220b1	Thermtronic temperature sensor
X220e1	Thermotronic control unit
X220f1	Roof AC blower fuse (30A)
X220f2	Thermtronic control module fuse (7.5 A)
X220f3	Roof AC rear evaporator fuse (7.5 A)
X220k1	Blower stage 1 relay
X220k2	Blower stage 2 relay
X220k3	Rear evaporator relay
X220m1	Blower motor
X220r1	Blower stages 1-2 series resistor
X220s1	Temperature

	switch
X220x1	Roof AC control unit connector
X220x2	Temperature sensor connector
X220x3	Blower connector
X220y1	Rear evaporator solenoid valve
X222	Roof AC switch connector
X230	Roof AC fuse connector

PE83.30-D-2001-60C	Legend of wiring diagram of climate control	Models WD1, WD2, WD3, WD6, WD7 Model 903.67 with CODE (HH7) Additional air conditioning in rear with CODE (ZU8) USA national version	
--------------------	---	---	--

Code	Designation	Coordinate
F149	Roof AC fuse (40 A)	31G
J16	Circuit 30 connector sleeve	31L
J19	Circuit 61 connector sleeve	30L
J46	Circuit 58 connector sleeve	23G
J429	Circuit 61 connector sleeve	27G
S137	Roof AC switch	26L
S138	Temperature switch	22L
W8	Ground point waistrail	25G
W41	Roof AC ground point	3A
X82	Frame/waistrail connector	30G
X220	Roof AC control unit	4L 12L
X220b1	Thermtronic temperature sensor	10L
X220e1	Thermtronic control unit	12L
X220f1	Roof AC blower fuse (30A)	4F
X220f2	Thermtronic control module fuse (7.5 A)	11F
X220f3	Roof AC rear evaporator fuse (7.5 A)	14F
X220k1	Blower stage 1 relay	5L
X220k2	Blower stage 2 relay	8L
X220k3	Rear evaporator relay	15L
X220m1	Blower motor	1L
X220r1	Blower stages 1-2 series resistor	3L
X220s1	Temperature switch	18L
X220x1	Roof AC control unit connector	1C
X220x2	Temperature sensor connector	9H
X220x3	Blower connector	1H
X220y1	Rear evaporator solenoid valve	17L

X222	Roof AC switch connector	20E
X230	Roof AC fuse connector	31E

GF00.19-D-3100-69B	Arrangement and assignment of climate control terminal blocks	Models WD1, WD2, WD3, WD6, WD7 Models 903.67 with code (HH7) Additional air conditioning in the rear with code (ZU8) National version for USA	
--------------------	---	--	--

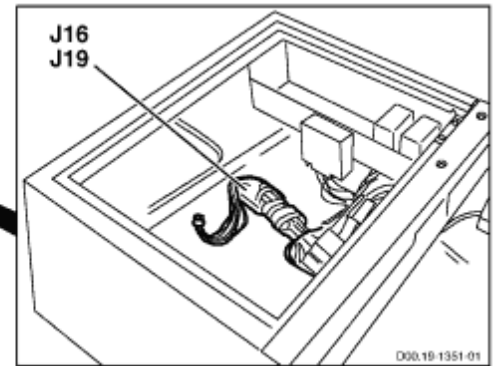
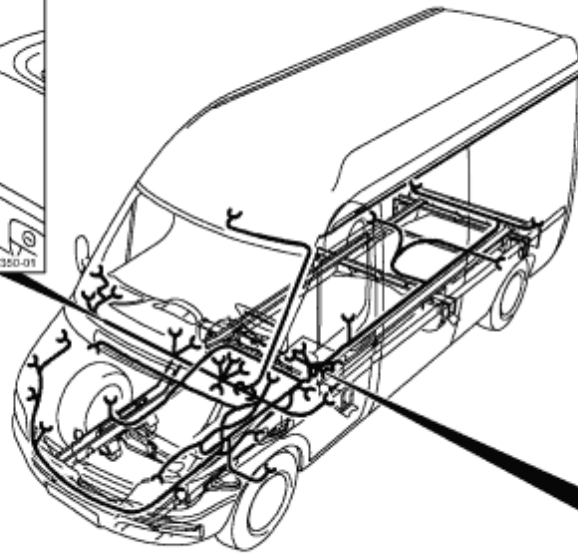
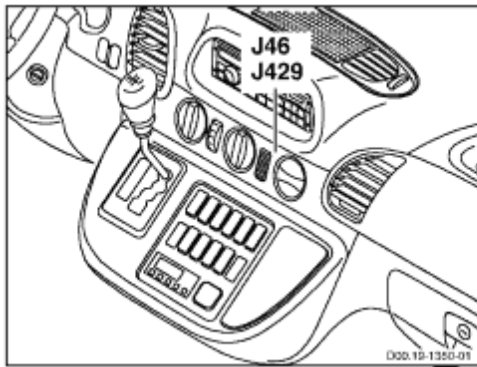

D00.19-1386-09

Terminal block	Designation		Component	Designation	Connector Pin
J16	FWH/seat frame (behind rubber grommet)	→	F6	ABS circuit 30 fuse	1
	Circuit 30 connector sleeve	→	F7	ABS circuit 30 fuse	1
		→	F9	Additional heater fuse (25 A)	1
		→	F11	Instrument cluster fuse (7.5 A)	1
		→	F40	Daytime running lamps fuse	1
		→	F43	Radio remote control fuse (10 A)	1
		→	F44	Central locking fuse (25 A)	1
		→	F62	Interior light fuse (15 A)	1
		→	F63	Heated rear window fuse (30 A)	1
		→			

			F98	Warm water heater stage 1 blower fuse (10 A)	1
		→	F101	Warm air additional heater fuse (7.5 A)	1
		→	F114	Additional heat exchanger fuse (25 A)	1
		→	F119	Air conditioning additional fan fuse (30 A)	1
		→	F138	Circuit 15 fuse (10 A)	1
		→	F140.3	Circuit 30 fuse (125 A)	2
		→	F143	Additional heater fuse (25 A)	1
		→	F148	Daytime running lamps relay fuse (10 A)	1
		→	F149	Roof AC fuse (40 A)	1
		→	F151	Fog lamp fuse (7.5 A)	1
		→	F153	Trailer socket fuse (25 A)	1
		→	F154	Instrument panel socket fuse (15 A)	1
		→	J327	Circuit 30 unfused connector sleeve	
		→	K26	Circuit D+ relay	1
J19	FWH/seat frame (behind rubber grommet)	→	A8	Central locking control module	1.8
	Circuit 61 connector sleeve	→	F66	Additional battery isolating relay fuse (15 A)	1
		→	F70	D+ relay fuse (15 A)	2
		→	K3	Heated rear window relay	4
		→	K78	Circuit D+ body manufacturer relay	4
		→	K135	Daytime running lamps terminal 58L relay	2
		→	K136	Daytime running lamps terminal 58R relay	2
		→	K140	Daytime running lamps circuit 58 relay	2
		→	X82	Frame/waistrail connector	13
J46	WWH (middle of instrument panel)	→	A9	Radio	1.A6
	Circuit 58 connector sleeve	→	A40	EWM control unit	2
		→	A71	Heater timer	1
		→	A81	Air conditioning pushbutton control	1.9

				and operating unit	
		→	E104	Ashtray lighting	1
		→	S12	Driver seat heater switch	1
		→	S25	Headlamp range adjustment switch	9
		→	S48	ASR switch	1
		→	S57	Differential lock switch	1
		→	S81	Rear window defroster pushbutton	1
		→	S85	Driver interior lighting pushbutton	1
		→	S87	Auxiliary heater switch	1
		→	S90	Roof fan switch	1
		→	S92	Panic alarm button	1
		→	S99	ATA [EDW] towing/interior motion sensor button	1
		→	S100	Additional heat exchanger double-contact pushbutton	1
		→	S107	Front passenger seat heater switch	1
		→	S119.1	Fog light switch	1
		→	S124	Reading lamp switch	1
		→	S126	Interior pushbutton	1
		→	S137	Roof AC switch	1
		→	S138	Temperature switch	9
		→	X79	Frame/waistrail connector	2
		→	X234	Cigar lighter illumination plug connection	3
J429	WWH (middle of instrument panel)	→	S137	Roof AC switch	3 8
	Circuit 61 connector sleeve	→	X82	Frame/waistrail connector	13

PE83.30-D-2001-99E

[Display in a separate window](#)

To display wiring diagrams, you need a
JAVA 1.1 capable Browser like e.g. "Microsoft Internet Explorer 4.0"
or
"Netscape Navigator 4.05" and higher with AWT 1.1 support

A12	Electrical center
A81	Air conditioning pushbutton control module
A81	Air conditioning pushbutton control module
A81	Air conditioning pushbutton control module
A81	Air conditioning pushbutton control module
A81s2	Blower thumbwheel switch
B28	Air outlet temperature sensor
B29	Evaporator temperature sensor
B56	Refrigerant pressure sensor
E90	Auxiliary warm water heater control module
F119	AC additional fan fuse (30 A)
J16	Circuit 30 connector sleeve
J46	Terminal 58 connector sleeve
J105	Terminal 15 connector sleeve
J343	Sensor ground connector sleeve
J372	Diagnostic line connector sleeve
J377	Circuit 30 connector sleeve
K77	AC additional fan relay
M4	Front blower LHD
M4x1	Front blower connector LHS
M4x2	Front blower connector LHS
M4x2	Front blower

	connector LHS
M45	Air conditioning auxiliary fan
M51	Circulating pump
P17	Diagnostic socket 16-pin
R10	Blower stages 1-3 series resistor
W2	Ground point right headlamp
W4	Ground point firewall
W4	Ground point firewall
W5	Ground point seat frame
W8	Ground point (wastrail)
X79	Frame/wastrail connector
X82	Frame/wastrail connector
X164	Warm water auxiliary heater connector, 2-pin
X165	Warm water auxiliary heater connector, 8-pin
X195	Frame/engine connector
X206	Heater connector
X237	Air mass meter connector
Y37	Water cycle valve
Y38	Air conditioning compressor clutch
Y95	Recirculated air solenoid valve



PE83.30-D-2001-60E	Legend of wiring diagram of climate control	<p>Models XD1, XD2, XD3, XD4, XD5, XD6, XD7, YD1##, YD2##, YD3##, YD4##, YD5##, YD6##, YD7##, WD1##, WD2##, WD3##, WD6##, WD7## ### from 365851 as of 21.1.02</p> <p>Models 903.61 /66 /67, 904.61 /66 with coDE (HH9) "Tempmatik" regulated air conditioning with CODE (ZU7) Canada national version</p> <p>Models 903.61# /66# /67#, 904.61# /66# ## from 365851 as of 21.1.02 with CODE (HH9) "Tempmatik" regulated air conditioning with CODE (ZU8) USA national version</p> <p>Models 903.61 /62 /66 /67, 904.61 /62 /66 with CODE (HH9) "Tempmatik" regulated air conditioning with CODE (ZU9) Mexico national version</p>	
--------------------	---	--	--

Code	Designation	Coordinate
A12	Electrical center	10L
A81	Air conditioning pushbutton control and operating unit	4A 12A 20A 28A
A81s2	Blower thumbwheel switch	1A
B28	Air outlet temperature sensor	13L
B29	Evaporator temperature sensor	14L
B56	Refrigerant pressure sensor	16L
E90	Warm water additional heater control unit	31L
F119	Air conditioning additional fan fuse (30 A)	27G
J16	Circuit 30 connector sleeve	27L
J46	Circuit 58 connector sleeve	10E

J105	Circuit 15 connector sleeve	4E
J343	Sensor ground connector sleeve	13G
J372	Diagnostic cable connector sleeve	20G
J377	Circuit 30 connector sleeve	11G
K77	Air conditioning additional fan relay	26L
M4	Front end blower LHS	6L
M4x1	Front blower connector LHS	7G
M4x2	Front blower connector LHS	5H 8H
M45	Air conditioning additional fan	24L
M51	Circulating pump	23L
P17	Diagnostic socket 16-pin	20L
R10	Blower stages 1-3 series resistor	2L
W2	Ground point right headlamp	24G
W4	Firewall ground point	7E 22G
W5	Seat frame ground point	25G
W8	Ground point waistrail	6E
X79	Frame/waistrail connector	11E
X82	Frame/waistrail connector	15E
X164	Warm water additional heater connector 2-pin	30H
X165	Warm water additional heater connector 8-pin	31H
X195	Frame/engine connector	28H
X206	Heater connector	8E
X237	Frame/engine connector	28H
Y37	Water cycle valve	21L
Y38	AC compressor clutch	29L
Y95	Recirculated air solenoid valve	8L

PE83.30-D-2001-99H

[Display in a separate window](#)

To display wiring diagrams, you need a
JAVA 1.1 capable Browser like e.g. "Microsoft Internet Explorer 4.0"
or
"Netscape Navigator 4.05" and higher with AWT 1.1 support

A200	Thermotronic control unit
B75	High pressure switch
B138	Temperature sensor
B138x1	Temperature sensor connector
F200	Roof AC fuse (80 A)
F201	Roof AC blower 1 fuse (30 A)
F202	Roof AC blower 2 fuse (30 A)
F203	Roof AC fan fuse (30 A)
F204	Roof AC compressor fuse (7,5 A)
G2	Battery
J19	Circuit 61 connector sleeve
J46	Terminal 58 connector sleeve
J46	Terminal 58 connector sleeve
J429	Circuit 61 connector sleeve
K201	Roof AC blower stage 2 relay
K203	Roof AC blower stage 1 and 2 relay
K204	Roof AC blower stage 1 relay
K205	Roof AC fan relay

K206	Roof AC compressor relay
M200	Blower motor
S137	Roof AC switch
S138	Temperature switch
V1	Thermotronic diode
V2	Blower stage 1 diode
W4	Ground point firewall
W8	Ground point (waistrail)
X82	Frame/waistrail connector
X217	Frame/dash support connector
X220	Roof AC connector
X220	Roof AC connector
X220	Roof AC connector
X222	Roof AC switch connector
X222	Roof AC switch connector
X222	Roof AC switch connector
X310	Roof AC control unit
X310	Roof AC control unit
X310b2	Low pressure switch
X310b4	Anti-icing switch
X310I1	Interference suppression capacitor

X310I1x1	Interference suppression capacitor connector
X310I2	Interference suppression capacitor
X310I2x1	Interference suppression capacitor connector
X310m1	Roof AC blower 1
X310m1x1	Roof AC blower 1 connector
X310m2	Roof AC blower 2
X310m2x1	Roof AC blower 2 connector
X313	Blower motor connector
Y69	Air conditioning compressor clutch

PE83.30-D-2001-60H	Legend of wiring diagram of climate control	<p>MODEL YD1, YD2, YD3, YD4, YD5, YD6, YD7, WD1, WD2, WD3, WD6, WD7</p> <p>MODEL 903.66 /67, 904.66 with CODE (H08) Heavy-duty air-conditioning system with CODE (ZU7) National version for Canada</p> <p>MODEL 903.66 /67, 904.66 with CODE (H08) Heavy-duty air-conditioning system with CODE (ZU8) National version for USA</p> <p>MODEL 903.66 /67, 904.66 with CODE (H08) Heavy-duty air-conditioning system with CODE (ZU9) National version for Mexico</p>	
--------------------	---	---	--

Code	Designation	Coordinate
A200	Thermotronic control unit	25L
B75	High pressure switch	37A
B138	Temperature sensor	24A
B138x1	Temperature sensor connector	24E
F200	Roof AC fuse (80 A)	14E
F201	Roof AC blower 1 fuse (30 A)	9G
F202	Roof AC blower 2 fuse (30 A)	6G
F203	Roof AC fan fuse (30 A)	30G
F204	Roof AC compressor fuse (7,5 A)	38G
G2	Battery	14A
J19	Circuit 61 connector sleeve	23E
J46	Circuit 58 connector sleeve	17E 26E
J429	Circuit 61 connector sleeve	21E
K201	Roof air conditioning blower stage 2 relay	11L
K203	Roof air conditioning blower stages 1 and 2 relay	8L
K204	Roof air conditioning blower stage 1 relay	14L
K205	Roof AC fan relay	32L
K206	Roof AC compressor relay	37L
M200	Blower motor	30A

S137	Roof AC switch	19A
S138	Temperature switch	27A
V1	Thermotronic diode	39A
V2	Blower stage diode 1	16A
W4	Firewall ground point	13E
W8	Waistrail ground point	18E
X82	Frame/waistrail connector	21G
X217	Frame/waistrail connector	40E
X220	Roof AC plug connection	19G 27G 39H
X222	Roof AC switch connector	19E 27E 40H
X310	Roof AC control unit	3A 34A
X310b2	Low pressure switch	35B
X310b4	Anti-icing switch	33B
X310I1	Interference suppression filter	3F
X310I1x1	Interference suppression filter connector	3H
X310I2	Interference suppression filter	1F
X310I2x1	Interference suppression filter connector	1H
X310m1	Roof AC blower 1	4B
X310m1x1	Roof AC blower 1 connector	3D
X310m2	Roof AC blower 2	2B
X310m2x1	Roof AC blower 2 connector	1D
X313	Blower motor connector	29E
Y69	AC compressor clutch	40A

PE54.25-D-2200-99C

[Display in a separate window](#)

To display wiring diagrams, you need a
JAVA 1.1 capable Browser like e.g. "Microsoft Internet Explorer 4.0"
or
"Netscape Navigator 4.05" and higher with AWT 1.1 support

A12	Electrical center
A12f1	Right side, tail lamp fuse
A12f2	Right high beam fuse
A12f3	Left high beam, high beam indicator fuse
A12f4	Backup lamp fuse
A12f5	Stop lamp fuse
A12f6	Windshield wiper motor fuse
A12f7	Horn, rear window defroster, circuit 15 relay fuse
A12f8	Interior lights, radio circuit 30 fuse
A12f9	Hazard warning light switch, parking light fuse
A12f10	Instrument lighting, license plate lamp fuse
A12f11	Left side, tail lamp fuse
A12f12	Right low beam fuse
A12f13	Left low beam fuse
A12f14	Fog lamp fuse
A12f15	Radio circuit 15 fuse
A12f16	Circuit 30 CDI control module fuse
A12f17	Circuit 30 CDI control module fuse
A12f18	Ignition circuit 15 fuse
A12f19	Locking element
A12f20	Air conditioning pushbutton control module circuit 30 fuse

A12f21	Front blower circuit 30 fuse
A12k1	Turn signal relay
A12k2	Wiper relay
A12k3	CDI motor electronics relay
A12n1	Wipers, turn signals, engine start control module
A12n1	Wipers, turn signals, engine start control module
A80	CDI control module
A94	CDI control module
F140	Fuse box
F140.6	Circuit 30 fuse (100 A)
G2	Battery
J4	Circuit 58R connector sleeve
J6	Circuit 30, fused, connector sleeve
J18	Circuit 15, fused, connector sleeve
J22	Circuit 15, fused, connector sleeve
J33	Circuit 58 connector sleeve
J38	Circuit 56 connector sleeve
J79	Circuit 58L connector sleeve
J80	Right turn signal lamp connector sleeve
J81	Left turn signal lamp connector sleeve
J148	Circuit 56b connector sleeve
J163	Circuit 15R connector sleeve

J277	Terminal 15 connector sleeve
J312	Circuit 30 connector sleeve
J342	Circuit 30 connector sleeve
J352	Circuit 50 connector sleeve
J377	Circuit 30 connector sleeve
J402	Exhaust gas recirculation connector sleeve
J431	Circuit 15R fused connector sleeve
S2	Combination switch
S2	Combination switch
S2	Combination switch
S2	Combination switch
S2	Combination switch
S2	Combination switch
S2	Combination switch
S2s1	High beam light selector switch
S2s2	Light switch
S2s3	Turn signal switch
S2s4	Hazard flasher switch
S2s5	Horn contact
S2s6	Washer pushbutton
S2s7	Wiper switch
W4	Ground point firewall
W4	Ground point firewall
X79	Frame/waistrail connector



PE54.25-D-2200-60C	Legend of wiring diagram of combination switch at electrical center, interior circuit	<p>MODEL XD1, XD2, XD3, XD4, XD5, XD6, XD7, YD1, YD2, YD3, YD4, YD5, YD6, YD7, WD1, WD2, WD3, WD6, WD7</p> <p>MODEL 903.61 /66 /67, 904.61 /66 with CODE (ZU7) National version Canada</p> <p>MODEL 903.61 /66 /67, 904.61 /66 with CODE (ZU8) National version USA</p> <p>MODEL 903.61 /62 /66 /67, 904.61 /62 /66 with CODE (ZU9) National version Mexico</p>	
--------------------	---	---	--

Code	Designation	Coordinate
A12	Electrical center	1G
A12f1	Right side, tail lamp fuse	26G
A12f2	Right main beam fuse	19G
A12f3	Left main beam, main beam indicator fuse	18G
A12f4	Reversing lamp fuse	28G
A12f5	Stop light fuse	21G
A12f6	Windshield wiper motor fuse	29G
A12f7	Horn, rear window defroster, circuit 15 relay fuse	14G
A12f8	Interior lights, radio circuit 30 fuse	13G
A12f9	Hazard warning light switch, parking light fuse	31G
A12f10	Instrument lighting, license plate lamp fuse	23G
A12f11	Left side, tail lamp fuse	25G
A12f12	Right low beam fuse	27G
A12f13	Left low beam fuse	26G
A12f14	Foglamp fuse	16G
A12f15	Radio circuit 15 fuse	30G
A12f16	Circuit 30 CDI control module fuse	3G
A12f17	Circuit 30 CDI control module fuse	2G
A12f18	Ignition circuit 15 fuse	28G
A12f19	Fuel pump relay fuse	6G

A12f20	Air conditioning pushbutton control module circuit 30 fuse	7G
A12f21	Front blower circuit 30 fuse	8G
A12k1	Turn signal relay	46C
A12k2	Wiper relay	51C
A12k3	CDI motor electronics relay	2C
A12n1	Wipers, turn signals, engine start control module	6C 48C
A80	CDI control unit	5L
A94	CDI control unit	6L
F140	Fuse box	11K
F140.6	Circuit 30 fuse (100 A)	12H
G2	Battery	10L
J4	Circuit R connector sleeve 58R	26K
J6	Circuit 30 fused connector sleeve	14L
J18	Circuit 15 fused connector sleeve	28K
J22	Circuit 15 fused connector sleeve	14L
J33	Circuit 58 connector sleeve	23K
J38	Circuit 56a connector sleeve	18K
J79	Circuit L connector sleeve 58L	25K
J80	Right turn signal light connector sleeve	35K
J81	Left turn signal light connector sleeve	36K
J148	Circuit 56b connector sleeve	26K
J163	Circuit R fused connector sleeve 15R	39L
J277	Circuit 15 connector sleeve	21K
J312	Circuit 30 connector sleeve	13L
J342	Circuit 30 connector sleeve	3J
J352	Circuit 50 connector sleeve	34K
J377	Circuit 30 connector sleeve	7K
J402	Exhaust gas recirculation connector sleeve	2J
J431	Circuit 15R, fused, connector sleeve	37K
S2	Combination switch	4A 12A 20A 28A 36A

		44A 51A
S2s1	Main beam light selector switch	20B
S2s2	Exterior light switch	27B
S2s3	Turn signal switch	32B
S2s4	Hazard warning switch	38B
S2s5	Horn contact	40B
S2s6	Washer pushbutton	41B
S2s7	Wiper switch	42B
W4	Firewall ground point	10H 45L
X79	Frame/waistrail connector	38J

GF00.19-D-3100-23C

Arrangement and assignment of terminal block connectors combination switch at electrical center interior circuit

Models XD1, XD2, XD3, XD4, XD5, XD6, XD7, YD1, YD2, YD3, YD4, YD5, YD6, YD7, WD1, WD2, WD3, WD6, WD7
Models 903.61/66/67, 904.61/66
with code (ZU7) National version for Canada
Models 903.61/66/67, 904.61/66
with code (ZU8) National version for USA
Models 903.61/62/66/67, 904.61/62/66
with code (ZU9) National version for Mexico

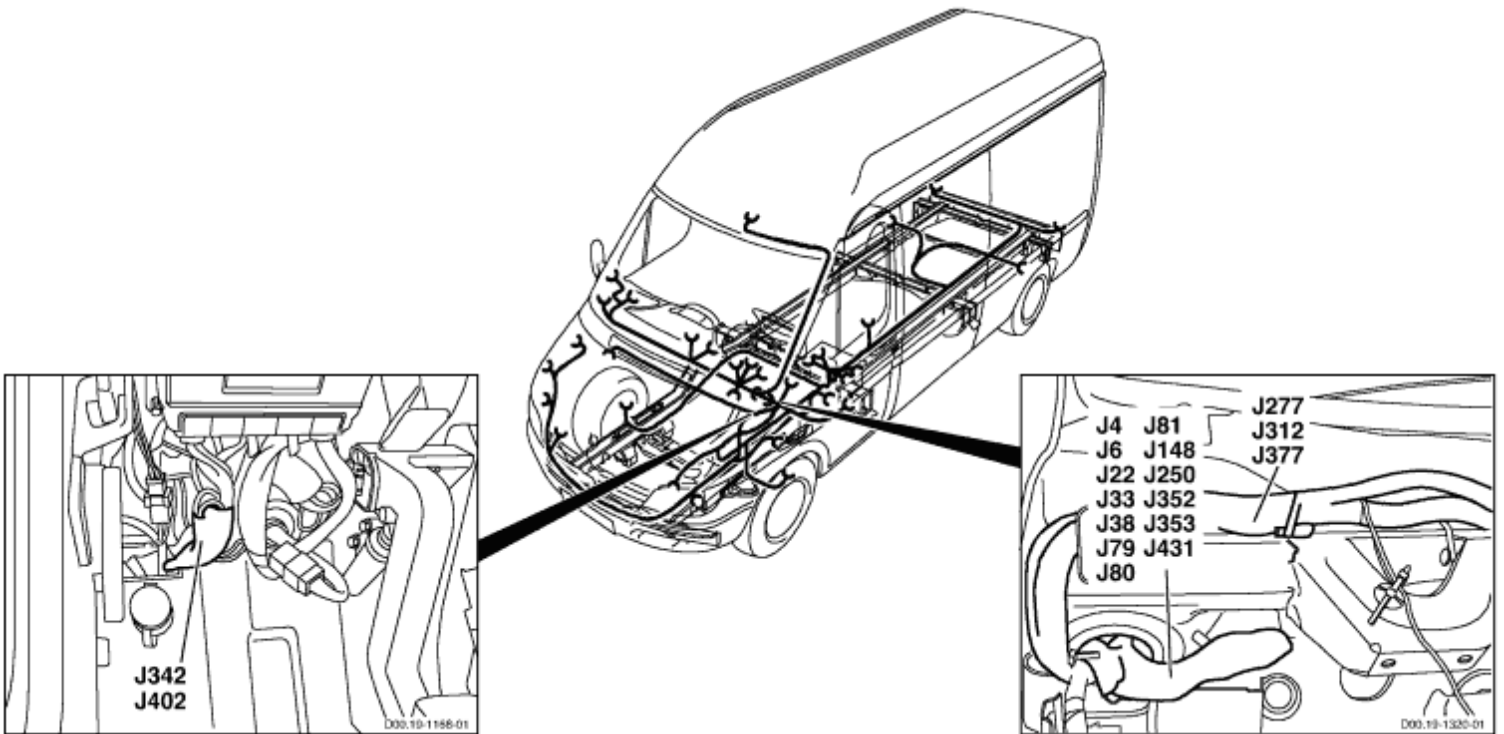

D00.19-1362-09

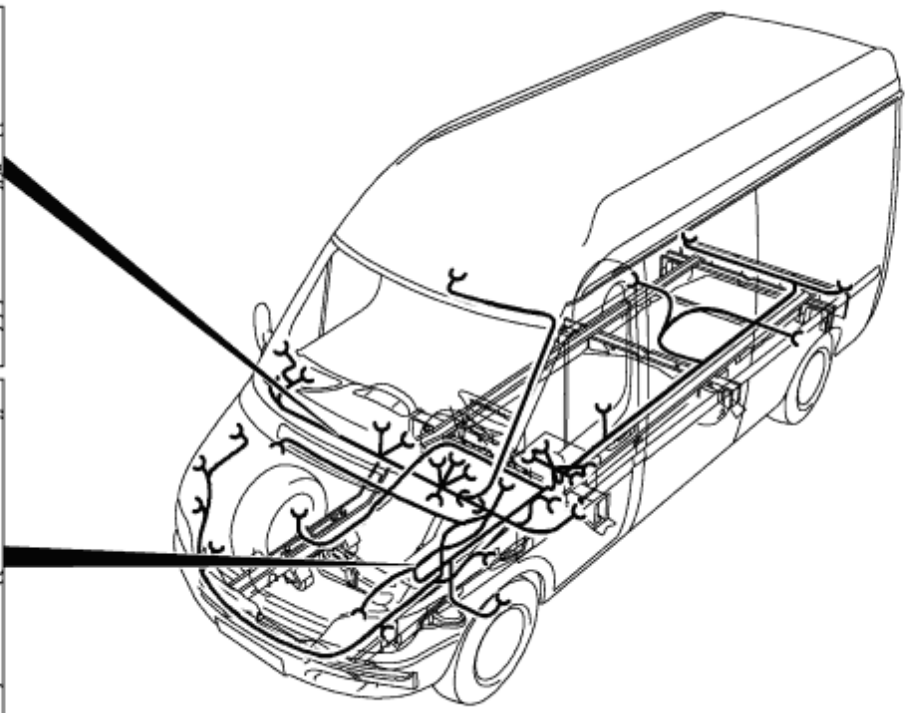
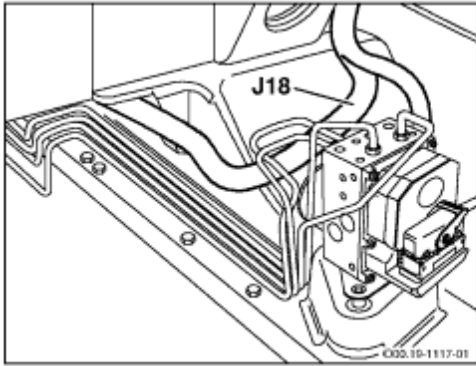
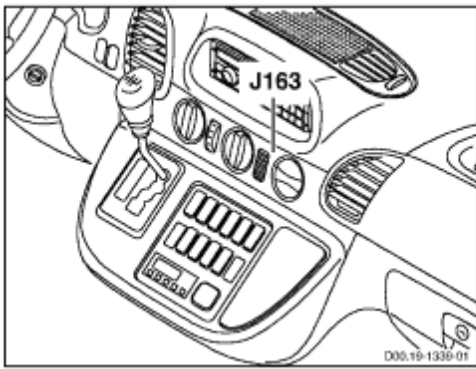

D00.19-1363-09

Terminal block	Designation		Component	Designation	Connector Pin
J4	FWH/waistrail (next to firewall rubber grommet)	→	A12	Electrical center	5.6
	Connector sleeve, terminal 58R	→	E26e6	Right side light	10
		→	E68E7	Right tail light	2
		→	K136	Daytime running lamps terminal 58R relay	1
J6	FWH/waistrail (next to firewall rubber grommet)	→	A12	Electrical center	4.11
	Circuit 30 fused connector sleeve	→	K101	Left EDW turn signal lamp relay	5
		→	K102	Right EDW turn signal lamp relay	5
		→	X45	Frame/roof connector (standard)	1
		→	X79	Frame/waistrail connector	8
J18	FWH/engine compartment (behind battery)	→	A10	Airbag control unit	1.5
	Circuit 15 fused connector sleeve	→	A12	Electrical center	4.3
		→	A80	CDI control unit	2.13
		→	K79	Circuit 15 body manufacturer relay	4

		→	P15	Instrument cluster	2.10
J22	FWH/waistrail (next to firewall rubber grommet)	→	A12	Electrical center	4.7
	Circuit 15 fused connector sleeve	→	A62	WSP control unit	7
		→	H17	Horn	2
		→	K37	Horn relay	4
		→	K70	Circuit 15 relay for optional equipment	2
		→	K103	Circulation pump relay	3
		→	K138	Circuit 15 relay	2
		→	X79	Frame/waistrail connector	1
		→	X80	Frame/waistrail connector	3
J33	FWH/waistrail (next to firewall rubber grommet)	→	A12	Electrical center	5.7
	Circuit 58 connector sleeve	→	J446	Circuit 58 connector sleeve	
		→	K140	Daytime running lamps circuit 58 relay	3
		→	X79	Frame/waistrail connector	2
J38	FWH/waistrail (next to firewall rubber grommet)	→	A12	Electrical center	4.5
	Circuit 56a connector sleeve	→	E25e66	Left high beam	9
		→	P15	Instrument cluster	2.8
J79	FWH/waistrail (next to firewall rubber grommet)	→	A12	Electrical center	5.4
	Connector sleeve, terminal 58L	→	E25e9	Left side light	10
		→	E67e8	Left tail light	2
		→	K135	Daytime running lamps terminal 58L relay	1.1
J80	FWH/waistrail (next to firewall rubber grommet)	→	A12	Electrical center	5.5
	Right turn signal light connector sleeve	→	A82	EDW control unit	1.4
		→	A93	Trailer socket control unit	2.B
		→	E26H3	Right front turn signal lamp	6
		→	E68h4	Right rear turn signal lamp	5
		→	H2	Right front side turn signal lamp (5 W)	1

		→	H9	Right front side turn signal lamp (21 W)	1
		→	K102	Right EDW turn signal lamp relay	1
		→	P15	Instrument cluster	1.7
J81	FWH/waistrail (next to firewall rubber grommet)	→	A12	Electrical center	5.8
	Left turn signal light connector sleeve	→	A62	WSP control unit	8
		→	A82	EDW control unit	1.1
		→	A93	Trailer socket control unit	2.E
		→	E25h21	Left front turn signal lamp	6
		→	E67h22	Left rear turn signal lamp	5
		→	H5	Left front side turn signal lamp (5 W)	1
		→	H10	Left front side turn signal lamp (21 W)	1
		→	K101	Left EDW turn signal lamp relay	1
		→	P15	Instrument cluster	2.13
J148	FWH/waistrail (next to firewall rubber grommet)	→	A12	Electrical center	5.13
	Circuit 56b connector sleeve	→	E25e64	Left low beam	7
		→	K68	Daytime running lamps relay	1 2
		→	K69	Daytime running lamps relay	2
		→	X79	Frame/waistrail connector	13
J163	WWH (middle of instrument panel)	→	A9	Radio	1.A7
	Connector sleeve, terminal 15R	→	W21	Active antenna (radio/telephone)	1
		→	X79	Frame/waistrail connector	7
J250	FWH/waistrail (next to firewall rubber grommet)	→	A12	Electrical center	5.14
	Wiper switch connector sleeve	→	K19	Headlamp cleaning system relay	2
		→	M58	Washer fluid pump	1
J277	FWH/waistrail (behind instrument cluster)	→	A12	Electrical center	5.1
	Circuit 15 connector sleeve	→	B127	Stop light switch 6-pin	1.2 2.1
		→	P17	Diagnostic socket 16-pin	8
J312	FWH/waistrail (behind instrument	→	A12	Electrical center	8

	cluster)				
	Circuit 30 connector sleeve	→	F140.6	Circuit 30 fuse (100 A)	
		→	X218	ATA [EDW] connector	1
J342	FWH (close to A80.1)	→	A12	Electrical center	5.2
	Circuit 30 connector sleeve	→	A80	CDI control unit	1.7 1.8
J352	FWH/waistrail (next to firewall rubber grommet)	→	A12	Electrical center	3.3
	Circuit 50 connector sleeve	→	A80	CDI control unit	3.20
		→	K61	Starter relay	1
J353	FWH/waistrail (next to firewall rubber grommet)	→	A12	Electrical center	4.8
	Fog light connector sleeve	→	K142	Fog lights relay	1
J377	FWH/waistrail (behind instrument cluster)	→	A12	Electrical center	4.1
	Circuit 30 connector sleeve	→	K103	Circulation pump relay	1
		→	X79	Frame/waistrail connector	3
J402	FWH (close to A80.1)	→	A12	Electrical center	4.4
	Exhaust gas recirculation connector sleeve	→	A80	CDI control unit	1.1
		→	X195	Frame/engine connector	4
J431	FWH/waistrail (next to firewall rubber grommet)	→	A8	Central locking control unit	1.10
	Circuit 15R, fused, connector sleeve	→	A12	Electrical center	4.9
		→	X79	Frame/engine connector	7

ENGINE612.981, 647.981 in MODEL XD1, XD2, XD3, XD4, XD5, XD6, XD7, YD1, YD2, YD3, YD4, YD5, YD6, YD7, WD1, WD2, WD3, WD6, WD7

ENGINE612.981, 647.981 in MODEL 903.61 /66 /67, 904.61 /66 with CODE (ZU7) National version for Canada

ENGINE612.981, 647.981 in MODEL 903.61 /66 /67, 904.61 /66 with CODE (ZU8) National version for USA

ENGINE612.981, 647.981 in MODEL 903.61 /62 /66 /67, 904.61 /62 /66 with CODE (ZU9) National version for Mexico

PE07.16-D-2000E	Wiring diagram of common rail diesel injection (CDI) control unit	<p>ENGINE 612.981 in MODEL XD1, XD2, XD3, XD4, XD5, XD6, XD7, YD1, YD2, YD3, YD4, YD5, YD6, YD7, WD1, WD2, WD3, WD6, WD7</p> <p>ENGINE 612.981 in MODEL 903.61 /66 /67, 904.61 /66 with CODE (ZU7) National version for Canada</p> <p>ENGINE 612.981 in MODEL 903.61 /66 /67, 904.61 /66 with CODE (ZU8) National version for USA</p> <p>ENGINE 612.981 in MODEL 903.61 /62 /66 /67, 904.61 /62 /66 with CODE (ZU9) National version for Mexico</p> <p>vehicle wiring harness</p>	PE07.16-D-2000E
PE07.16-D-2000F	Wiring diagram of common rail diesel injection (CDI) control unit	<p>ENGINE 612.981 in MODEL XD1, XD2, XD3, XD4, XD5, XD6, XD7, YD1, YD2, YD3, YD4, YD5, YD6, YD7, WD1, WD2, WD3, WD6, WD7</p> <p>ENGINE 612.981 in MODEL 903.61 /66 /67, 904.61 /66 with CODE (ZU7) National version for Canada</p> <p>ENGINE 612.981 in MODEL 903.61 /66 /67, 904.61 /66 with CODE (ZU8) National version for USA</p> <p>ENGINE 612.981 in MODEL 903.61 /62 /66 /67, 904.61 /62 /66 with CODE (ZU9) National</p>	PE07.16-D-2000F

		version for Mexico engine wiring harness	
PE07.16-D-2000G	Wiring diagram of common rail diesel injection (CDI) control unit	ENGINE 647.981 in MODEL XD1, XD2, XD3, XD4, XD5, XD6, XD7, YD1, YD2, YD3, YD4, YD5, YD6, YD7, WD1, WD2, WD3, WD6, WD7 ENGINE 647.981 in MODEL 903.61 /66 /67, 904.61 /66 with CODE (ZU7) National version for Canada ENGINE 647.981 in MODEL 903.61 /66 /67, 904.61 /66 with CODE (ZU8) National version for USA ENGINE 647.981 in MODEL 903.61 /62 /66 /67, 904.61 /62 /66 with CODE (ZU9) National version for Mexico engine wiring harness	PE07.16-D-2000G
PE07.16-D-2000H	Wiring diagram of common rail diesel injection (CDI) control unit	ENGINE 647.981 in MODEL XD1, XD2, XD3, XD4, XD5, XD6, XD7, YD1, YD2, YD3, YD4, YD5, YD6, YD7, WD1, WD2, WD3, WD6, WD7 ENGINE 647.981 in MODEL 903.61 /66 /67, 904.61 /66 with CODE (ZU7) National version for Canada ENGINE 647.981 in MODEL 903.61 /66 /67, 904.61 /66 with CODE (ZU8) National version for USA ENGINE 647.981 in MODEL 903.61 /62 /66 /67, 904.61 /62 /66 with CODE (ZU9) National version for Mexico vehicle wiring harness	PE07.16-D-2000H

PE82.10-D-2501-99A

[Display in a separate window](#)

To display wiring diagrams, you need a
JAVA 1.1 capable Browser like e.g. "Microsoft Internet Explorer 4.0"
or
"Netscape Navigator 4.05" and higher with AWT 1.1 support

A12	Electrical center
E25	Left headlight
E25e4	Left fog light
E26	Right headlight
E26e5	Right fog headlight
J16	Circuit 30 connector sleeve
J355	Fog light ON connector sleeve
J46	Circuit 58 connector sleeve
K142	Fog light relay
S119.1	Fog light switch
W5	Ground point seat frame
W8	Ground point wastrail
X79	Frame/wastrail plug connection

PE82.10-D-2501-60A	Legend of wiring diagram of fog lights	<p>Model XD1, XD2, XD3, XD4, XD5, XD6, XD7, YD1, YD2, YD3, YD4, YD5, YD6, YD7, WD1, WD2, WD3, WD6, WD7</p> <p>Models 903.61 /66 /67, 904.61 /66 with CODE (L16) halogen fog lamp with CODE (ZU7) Canada national version</p> <p>Models 903.61 /66 /67, 904.61 /66 with CODE (L16) halogen fog lamp with CODE (ZU8) USA national version</p> <p>Models 903.61 /62 /66 /67, 904.61 /62 /66 with CODE (L16) halogen fog lamp with CODE (ZU9) Mexico national version</p>	
--------------------	--	---	--

Code	Designation	Coordinate
A12	Electrical center	1A
E25	Left headlamp	2A
E25e4	Left fog lamp	2B
E26	Right headlamp	3A
E26e5	Right fog lamp	3B
F151	Fog lamp fuse (7.5 A)	4E
J16	Circuit 30 connector sleeve	5A
J46	Circuit 58 connector sleeve	6G
J355	Fog light ON connector sleeve	2E
K142	Fog lights relay	2L
S119.1	Fog light switch	5L
W5	Seat frame ground point	3G
W8	Ground point waistrail	7G
X79	Frame/waistrail connector	4G

GF00.19-D-3100-68A	Arrangement and assignment of terminal block connectors, fog light	<p>Models XD1, XD2, XD3, XD4, XD5, XD6, XD7, YD1, YD2, YD3, YD4, YD5, YD6, YD7, WD1, WD2, WD3, WD6, WD7</p> <p>Models 903.61/66/67, 904.61/66 with code (L16) Halogen fog lamp with code (ZU7) National version for Canada</p> <p>Models 903.61/66/67, 904.61/66 with code (L16) Halogen fog lamp with code (ZU8) National version for USA</p> <p>Models 903.61/62/66/67, 904.61/62/66 with code (L16) Halogen fog lamp with code (ZU9) National version for Mexico</p>	
--------------------	--	---	--

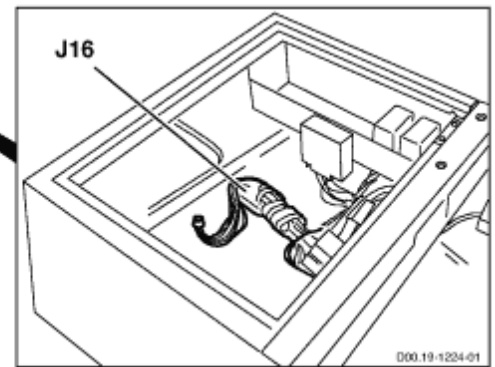
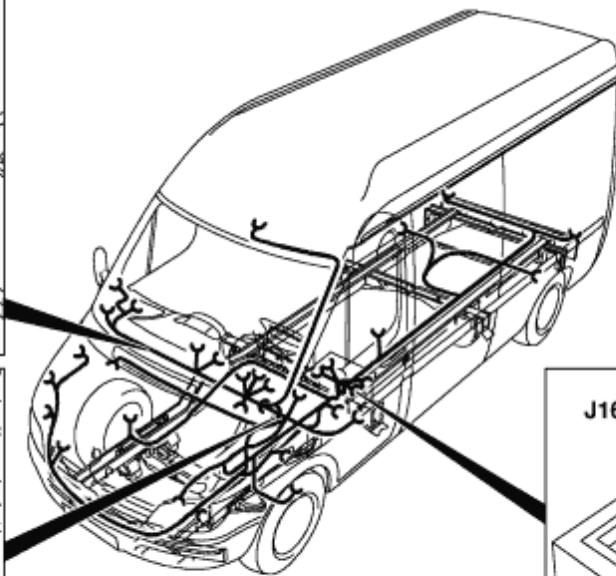
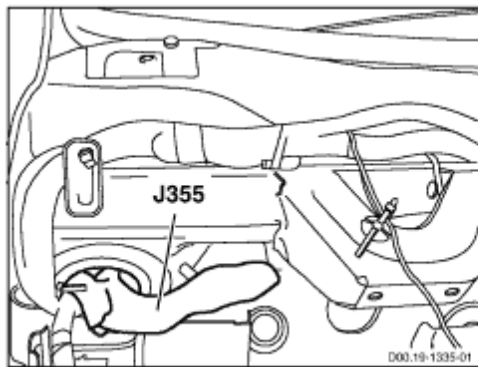
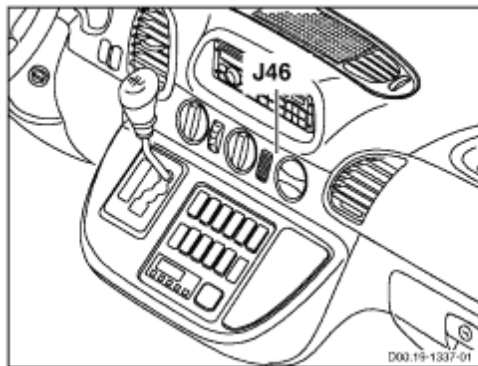

D00.19-1378-09

Terminal block	Designation	Component	Designation	Connector
----------------	-------------	-----------	-------------	-----------

					Pin
J16	FWH/seat frame (behind rubber grommet)	→	F6	ABS circuit 30 fuse	1
	Circuit 30 connector sleeve	→	F7	ABS circuit 30 fuse	1
		→	F9	Additional heater fuse (25 A)	1
		→	F11	Instrument cluster fuse (7.5 A)	1
		→	F40	Daytime running lamps fuse	1
		→	F43	Radio remote control fuse (10 A)	1
		→	F44	Central locking fuse (25 A)	1
		→	F62	Interior light fuse (15 A)	1
		→	F63	Heated rear window fuse (30 A)	1
		→	F98	Warm water heater stage 1 blower fuse (10 A)	1
		→	F101	Warm air additional heater fuse (7.5 A)	1
		→	F114	Additional heat exchanger fuse (25 A)	1
		→	F119	Air conditioning additional fan fuse (30 A)	1
		→	F138	Circuit 15 fuse (10 A)	1
		→	F140.3	Circuit 30 fuse (125 A)	2
		→	F143	Additional heater fuse (25 A)	1
		→	F148	Daytime running lamps relay fuse (10 A)	1
		→	F149	Roof AC fuse (40 A)	1
		→	F151	Fog lamp fuse (7.5 A)	1
		→	F153	Trailer socket fuse (25 A)	1
		→	F154	Instrument panel socket fuse (15 A)	1
		→	J327	Circuit 30 unfused connector sleeve	
		→	K26	Circuit D+ relay	1
J46	WWH (middle of instrument panel)	→	A9	Radio	1.A6
	Circuit 58 connector sleeve	→	A40	EWM control unit	2
		→	A71	Heater timer	1
		→	A81	Air conditioning pushbutton control and operating unit	1.9
		→	E104	Ashtray lighting	1

		→	S12	Driver seat heater switch	1
		→	S25	Headlamp range adjustment switch	9
		→	S48	ASR switch	1
		→	S57	Differential lock switch	1
		→	S81	Rear window defroster pushbutton	1
		→	S85	Driver interior lighting pushbutton	1
		→	S87	Auxiliary heater switch	1
		→	S90	Roof fan switch	1
		→	S92	Panic alarm button	1
		→	S99	ATA [EDW] towing/interior motion sensor button	1
		→	S100	Additional heat exchanger double-contact pushbutton	1
		→	S107	Front passenger seat heater switch	1
		→	S119.1	Fog light switch	1
		→	S124	Reading lamp switch	1
		→	S126	Interior pushbutton	1
		→	S137	Roof AC switch	1
		→	S138	Temperature switch	9
		→	X79	Frame/waistrail connector	2
		→	X234	Cigar lighter illumination plug connection	3
J355	FWH/waistrail (next to firewall rubber grommet)	→	E25e4	Left fog lamp	2
	Fog light ON connector sleeve	→	E26e5	Right fog lamp	2
		→	K142	Fog lights relay	5

PE54.22-D-2000-99E

[Display in a separate window](#)

To display wiring diagrams, you need a
JAVA 1.1 capable Browser like e.g. "Microsoft Internet Explorer 4.0"
or
"Netscape Navigator 4.05" and higher with AWT 1.1 support

A2	ABS control module
A4	ETC control module
A8	Central locking control module
A9	Car radio
A10	Airbag control module
A12	Electrical center
A12f5	Stop lamp fuse
A40	Electronic selector lever module control module
A62	WSP control module
A80	CDI control module
A81	Air conditioning pushbutton control module
A82	ATA 2 control module
A94	CDI control module
E18	Warm air auxiliary heater control module
E90	Auxiliary warm water heater control module
F11	Instrument cluster fuse (7.5 A)
J16	Circuit 30 connector sleeve
J277	Terminal 15 connector sleeve
J372	Diagnostic line connector sleeve
J375	Diagnostic line connector sleeve
J401	Diagnostic line connector sleeve
J415	Circuit 30 connector sleeve
J424	Diagnostic line connector sleeve
P15	Instrument cluster
P17	Diagnostic socket

	16-pin
P17	Diagnostic socket 16-pin
P17	Diagnostic socket 16-pin
P17	Diagnostic socket 16-pin
S53	Steering lock with mechanical repeat start lockout
W4	Ground point firewall
X5.1	Auxiliary heater connector LHD
X79	Frame/waistrail connector
X82	Frame/waistrail connector
X165	Warm water auxiliary heater connector, 8-pin
X217	Frame/dash support connector
X217	Frame/dash support connector

PE54.22-D-2000-60E	Legend of wiring diagram for data link connector / diagnostic socket	<p>MODEL XD1, XD2, XD3, XD4, XD5, XD6, XD7, YD1, YD2, YD3, YD4, YD5, YD6, YD7, WD1, WD2, WD3, WD6, WD7</p> <p>MODEL 903.61 /66 /67, 904.61 /66 with CODE (ZU7) national version for Canada</p> <p>MODEL 903.61 /66 /67, 904.61 /66 with CODE (ZU8) national version for USA</p> <p>MODEL 903.61 /62 /66 /67, 904.61 /62 /66 with CODE (ZU9) national version for Mexico</p>	
--------------------	--	---	--

Code	Designation	Coordinate
A2	ABS/ESP control unit	15L
A4	ETC [EGS] control unit	11L
A8	Central locking control unit	21L
A9	Radio	13L
A10	Airbag control unit	6L
A12	Electrical center	2L
A12f5	Stop light fuse	2K
A40	EWM control unit	16L
A62	WSP control unit	17L
A80	CDI control unit	7L
A81	Air conditioning control and operating unit	27L
A82	EDW control unit	19L
A94	CDI control unit	10L
E18	Warm air auxiliary heater control unit	22L
E90	Warm water additional heater control unit	24L
F11	Instrument cluster fuse (7.5 A)	4H
J16	Tml. 30 connector sleeve	5L
J277	Circuit 15 connector sleeve	1G
J372	Diagnostic cable connector sleeve	25G
J375	Diagnostic cable connector sleeve	19G

J401	Diagnostic cable connector sleeve	15E
J415	Tml. 30 connector sleeve	4E
J424	Diagnostic cable connector sleeve	11E
P15	Instrument cluster	26L
P17	Diagnostic socket 16-pin	4A 12A 20A 26A
S53	Steering lock with mechanical repeat start lockout	3L
W4	Firewall ground point	2E
X5.1	Additional heater connector LHS	22H
X79	Frame/waistrail connector	13H
X82	Frame/waistrail connector	27H
X165	Warm water additional heater connector 8-pin	23H
X217	Frame/waistrail connector	12H 15H

GF00.19-D-3100-22C	Arrangement and assignment of terminal blocks of data link connector/diagnostic socket	<p>Models XD1, XD2, XD3, XD4, XD5, XD6, XD7, YD1, YD2, YD3, YD4, YD5, YD6, YD7, WD1, WD2, WD3, WD6, WD7</p> <p>Models 903.61/66/67, 904.61/66 with code (ZU7) National version for Canada</p> <p>Models 903.61/66/67, 904.61/66 with code (ZU8) National version for USA</p> <p>Models 903.61/62/66/67, 904.61/62/66 with code (ZU9) National version for Mexico</p>	
--------------------	--	--	--

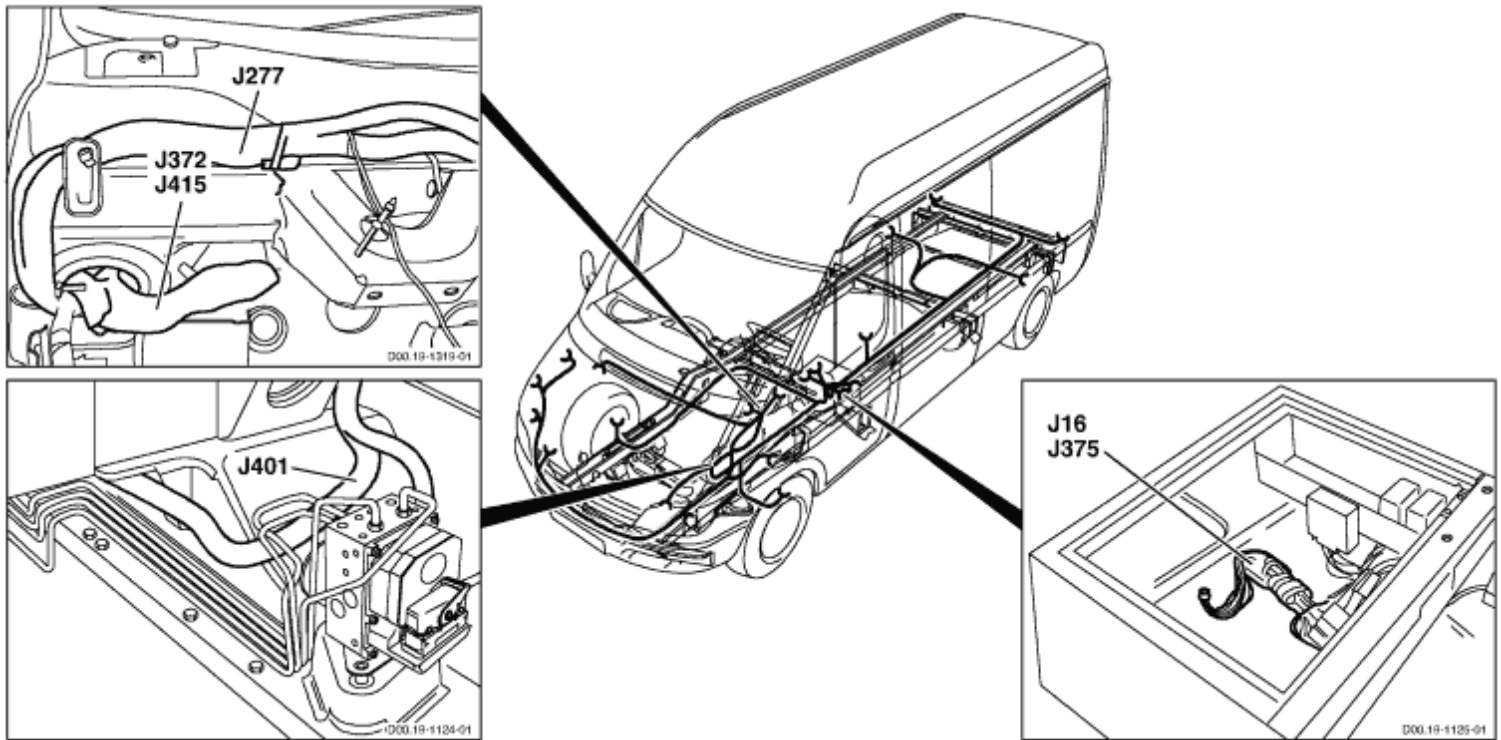

D00.19-1361-09

Terminal block	Designation		Component	Designation	Connector Pin
J16	FWH/seat frame (behind rubber grommet)	→	F6	ABS circuit 30 fuse	1
	Circuit 30 connector sleeve	→	F7	ABS circuit 30 fuse	1

		→	F9	Additional heater fuse (25 A)	1
		→	F11	Instrument cluster fuse (7.5 A)	1
		→	F40	Daytime running lamps fuse	1
		→	F43	Radio remote control fuse (10 A)	1
		→	F44	Central locking fuse (25 A)	1
		→	F62	Interior light fuse (15 A)	1
		→	F63	Heated rear window fuse (30 A)	1
		→	F98	Warm water heater stage 1 blower fuse (10 A)	1
		→	F101	Warm air additional heater fuse (7.5 A)	1
		→	F114	Additional heat exchanger fuse (25 A)	1
		→	F119	Air conditioning additional fan fuse (30 A)	1
		→	F138	Circuit 15 fuse (10 A)	1
		→	F140.3	Circuit 30 fuse (125 A)	2
		→	F143	Additional heater fuse (25 A)	1
		→	F148	Daytime running lamps relay fuse (10 A)	1
		→	F149	Roof AC fuse (40 A)	1
		→	F151	Fog lamp fuse (7.5 A)	1
		→	F153	Trailer socket fuse (25 A)	1
		→	F154	Instrument panel socket fuse (15 A)	1
		→	J327	Circuit 30 unfused connector sleeve	
		→	K26	Circuit D+ relay	1
J277	FWH/waistrail (behind instrument cluster)	→	A12	Electrical center	5.1
	Circuit 15 connector sleeve	→	B127	Stop light switch 6-pin	1.2 2.1
		→	P17	Diagnostic socket 16-pin	8
J372	FWH/waistrail (next to firewall rubber grommet)	→	P15	Instrument cluster	1.4
	Diagnostic cable connector sleeve	→	P17	Diagnostic socket 16-pin	15
		→	X82	Frame/waistrail connector	2
		→	X165	Warm water auxiliary heater connector,	5

				8-pin	
J375	FWH/seat frame (behind rubber grommet)	→	A8	Central locking control unit	1.12
	Diagnostic cable connector sleeve	→	A82	EDW control unit	2.8
		→	P17	Diagnostic socket 16-pin	12
		→	X5.1	Additional heater connector LHS	3
J401	FWH/engine compartment (behind battery)	→	A2	ABS/ESP control unit	11
	Diagnostic cable connector sleeve	→	P17	Diagnostic socket 16-pin	9
		→	X217	Frame/waistrail connector	4
J415	FWH/waistrail (next to firewall rubber grommet)	→	F11	Instrument cluster fuse (7.5 A)	2
	Circuit 30 connector sleeve	→	P15	Instrument cluster	2.3
		→	P17	Diagnostic socket 16-pin	16

To display wiring diagrams, you need a
 JAVA 1.1 capable Browser like e.g. "Microsoft Internet Explorer 4.0"
 or
 "Netscape Navigator 4.05" and higher with AWT 1.1 support

A9	Car radio
A9	Car radio
A9	Car radio
A9	Car radio
A12	Electrical center
A12f15	Radio circuit 15 fuse
B14	Driver double coil speaker
B22	Left rear speaker
B23	Right rear speaker
B85	Left front speaker LHS
B85.1	Left front speaker LHS
B85.2	Left front speaker LHS
B86	Right front speaker LHS
B86.1	Right front speaker LHS
B86.2	Right front speaker LHS
J46	Terminal 58 connector sleeve
J58	Circuit 30 connector sleeve
J163	Circuit 15R connector sleeve
J394	Vehicle speed signal connector sleeve
J424	Diagnostic line connector sleeve
J483	Vehicle speed signal connector sleeve
P15	Instrument cluster
P17	Diagnostic socket 16-pin
S53	Steering lock with mechanical repeat start lockout
W8	Ground point (wastrail)
W20	Active antenna (preinstallation/radio)
X20	Driver double coil

	speaker connector
X43	Waistrail/roof connector
X79	Frame/waistrail connector
X79	Frame/waistrail connector
X217	Frame/dash support connector

PE82.60-D-2000-60E	Legend for wiring diagram of radio	<p>MODEL XD1, XD2, XD3, XD4, XD5, XD6, XD7, YD1, YD2, YD3, YD4, YD5, YD6, YD7, WD1, WD2, WD3, WD6, WD7</p> <p>MODEL 903.61 /66 /67, 904.61 /66</p> <p>with CODE (E77) Additional stereo speakers</p> <p>with CODE (EF5) Sound 10 radio</p> <p>with CODE (EF7) Sound 30 radio</p> <p>with CODE (ZU7) National version for Canada</p> <p>MODEL 903.61 /66 /67, 904.61 /66</p> <p>with CODE (E77) Additional stereo speakers</p> <p>with CODE (EF5) Sound 10 radio</p> <p>with CODE (EF7) Sound 30 radio</p> <p>with CODE (ZU8) National version for USA</p> <p>MODEL 903.61 /62 /66 /67, 904.61 /62 /66</p> <p>with CODE (EF5) Sound 10 radio</p> <p>with CODE (ZU9) National version for Mexico</p>	
--------------------	------------------------------------	--	--

Code	Designation	Coordinate
A9	Radio	3A 12A 20A 25A
A12	Electrical center	17L
A12f15	Radio circuit 15 fuse	17K
B14	Driver dual coil speaker	12L
B22	Left rear speaker	2L
B23	Right rear speaker	3L
B85	Left front speaker LHD	6L
B85.1	Left front speaker LHD	5H
B85.2	Left front speaker LHD	6H

B86	Right front speaker LHD	9L
B86.1	Right front speaker LHD	8H
B86.2	Right front speaker LHD	9H
J46	Circuit 58 connector sleeve	11E
J58	Circuit 30 connector sleeve	19E
J163	Circuit R connector sleeve 15R	17E
J394	Vehicle speed signal connector sleeve	19H
J424	Diagnostic cable connector sleeve	22L
J483	Vehicle speed signal connector sleeve	18E
P15	Instrument cluster	20L
P17	Diagnostic socket 16-pin	21L
S53	Steering lock with mechanical repeat start lockout	15L
W8	Waistrail ground point	12E
W20	Active antenna (preinstallation/radio)	24L
X20	Driver dual coil speaker connector	13H
X43	Waistrail/roof connector	1H
X79	Frame/waistrail connector	17H 23H
X217	Frame/waistrail connector	21H

<p>GF00.19-D-3100-42C</p>	<p>Arrangement and assignment of terminal block connectors radio</p>	<p>Models XD1, XD2, XD3, XD4, XD5, XD6, XD7, YD1, YD2, YD3, YD4, YD5, YD6, YD7, WD1, WD2, WD3, WD6, WD7 Models 903.61/66/67, 904.61/66 with code (E77) Additional stereo speakers with code (EF5) Sound 10 radio with code (EF7) Sound 30 radio with code (ZU7) National version for Canada Models 903.61/66/67, 904.61/66 with code (E77) Additional stereo speakers with code (ef5) sound 10 radio with code (EF7) Sound 30 radio with code (ZU8) National version for USA Models 903.61/62/66/67, 904.61/62/66 with code (EF5) Sound 10 radio with code (ZU9) National version for Mexico</p>	
---------------------------	--	---	--

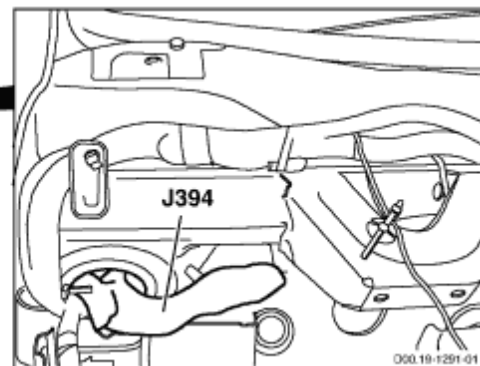
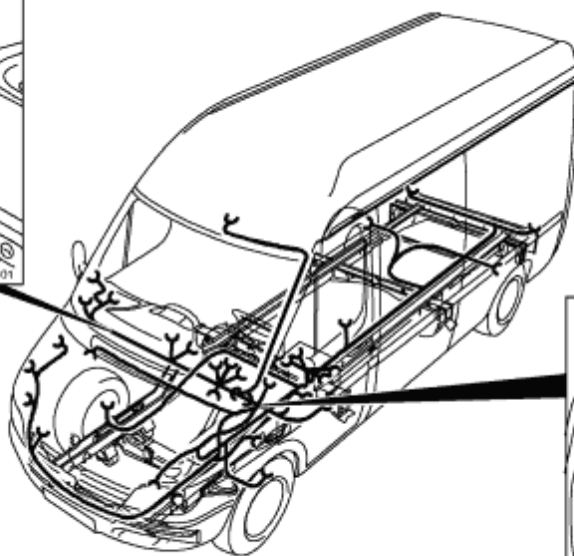
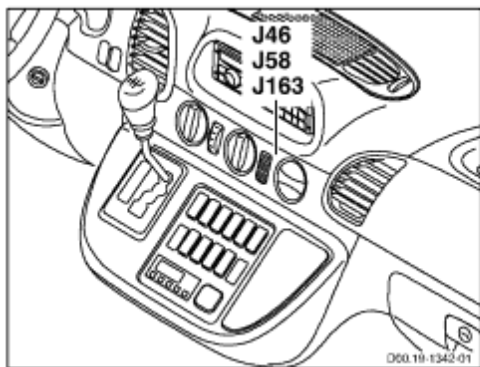

D00.19-1381-09

Terminal block	Designation		Component	Designation	Connector Pin
J46	WWH (middle of instrument panel)	→	A9	Radio	1.A6
	Circuit 58 connector sleeve	→	A40	EWM control unit	2
		→	A71	Heater timer	1
		→	A81	Air conditioning pushbutton control and operating unit	1.9
		→	E104	Ashtray lighting	1
		→	S12	Driver seat heater switch	1
		→	S25	Headlamp range adjustment switch	9
		→	S48	ASR switch	1
		→	S57	Differential lock switch	1
		→	S81	Rear window defroster pushbutton	1
		→	S85	Driver interior lighting pushbutton	1
		→	S87	Auxiliary heater switch	1
		→	S90	Roof fan switch	1
		→	S92	Panic alarm button	1
		→	S99	ATA [EDW] towing/interior motion sensor button	1

		→	S100	Additional heat exchanger double-contact pushbutton	1
		→	S107	Front passenger seat heater switch	1
		→	S119.1	Fog light switch	1
		→	S124	Reading lamp switch	1
		→	S126	Interior pushbutton	1
		→	S137	Roof AC switch	1
		→	S138	Temperature switch	9
		→	X79	Frame/waistrail connector	2
		→	X234	Cigar lighter illumination plug connection	3
J58	WWH (middle of instrument panel)	→	A9	Radio	1.A4
	Circuit 30 connector sleeve	→	S87	Auxiliary heater switch	3
		→	X79	Frame/waistrail connector	8
		→	X234	Cigar lighter illumination plug connection	1
J163	WWH (middle of instrument panel)	→	A9	Radio	1.A7
	Connector sleeve, terminal 15R	→	W21	Active antenna (radio/telephone)	1
		→	X79	Frame/waistrail connector	7
J394	FWH/waistrail (next to firewall rubber grommet)	→	P15	Instrument cluster	2.9
	Vehicle speed signal connector sleeve	→	X79	Frame/waistrail connector	6

PE82.10-D-2200-99D[Display in a separate window](#)

To display wiring diagrams, you need a
JAVA 1.1 capable Browser like e.g. "Microsoft Internet Explorer 4.0"
or
"Netscape Navigator 4.05" and higher with AWT 1.1 support

A12	Electrical center
A12	Electrical center
A82	ATA 2 control module
E25	Left headlamp
E25h21	Left turn signal light
E26	Right headlamp
E26h3	Right turn signal light
E67	Left rear lamp
E67h22	Left rear turn signal lamp
E68	Right rear lamp
E68h4	Right rear turn signal lamp
H2	Right front side turn signal lamp (5W)
H5	Left front side turn signal lamp (5W)
H9	Right front side turn signal lamp (21W)
H10	Left front side turn signal light (21 W)
J80	Right turn signal lamp connector sleeve
J80	Right turn signal lamp connector sleeve
J81	Left turn signal lamp connector sleeve
J81	Left turn signal lamp connector sleeve
P15	Instrument cluster
W2	Ground point right headlamp
W7	Ground point (engine compartment)



PE82.10-D-2200-60D	Legend for wiring diagram of turn signal/hazard warning lamps	<p>Models XD1, XD2, XD3, XD4, XD5, XD6, XD7, YD1, YD2, YD3, YD4, YD5, YD6, YD7, WD1, WD2, WD3, WD6, WD7</p> <p>Models 903.61 /66 /67, 904.61 /66 with CODE (ZU7) Canada national version</p> <p>Models 903.61 /66 /67, 904.61 /66 with CODE (ZU8) USA national version</p> <p>Models 903.61 /62 /66 /67, 904.61 /62 /66 with CODE (ZU9) Mexico national version</p>	
--------------------	---	---	--

Code	Designation	Coordinate
A12	Electrical center	6A 11A
A82	ATA control unit	8L
E25	Left headlamp	7L
E25h21	Left turn signal lamp	7K
E26	Right headlamp	13L
E26h3	Right turn signal lamp	13K
E67	Left rear lamp	5L
E67h22	Left rear turn signal lamp	5K
E68	Right rear lamp	14L
E68h4	Right rear turn signal lamp	14K
H2	Right front side turn signal lamp (5 W)	12L
H5	Left front side turn signal lamp (5 W)	6L
H9	Right front side turn signal lamp (21 W)	12L
H10	Left front side turn signal lamp (21 W)	6L
J80	Right turn signal light connector sleeve	1E 11E
J81	Left turn signal light connector sleeve	5E 9G
P15	Instrument cluster	10L
W2	Ground point right headlamp	12H

GF00.19-D-3100-38C	Arrangement and assignment of terminal block connectors turn signal/hazard warning lights	<p>Models XD1, XD2, XD3, XD4, XD5, XD6, XD7, YD1, YD2, YD3, YD4, YD5, YD6, YD7, WD1, WD2, WD3, WD6, WD7</p> <p>Models 903.61/66/67, 904.61/66 with code (ZU7) National version for Canada</p> <p>Models 903.61/66/67, 904.61/66 with code (ZU8) National version for USA</p> <p>Models 903.61/62/66/67, 904.61/62/66 with code (ZU9) National version for Mexico</p>	
--------------------	---	--	--

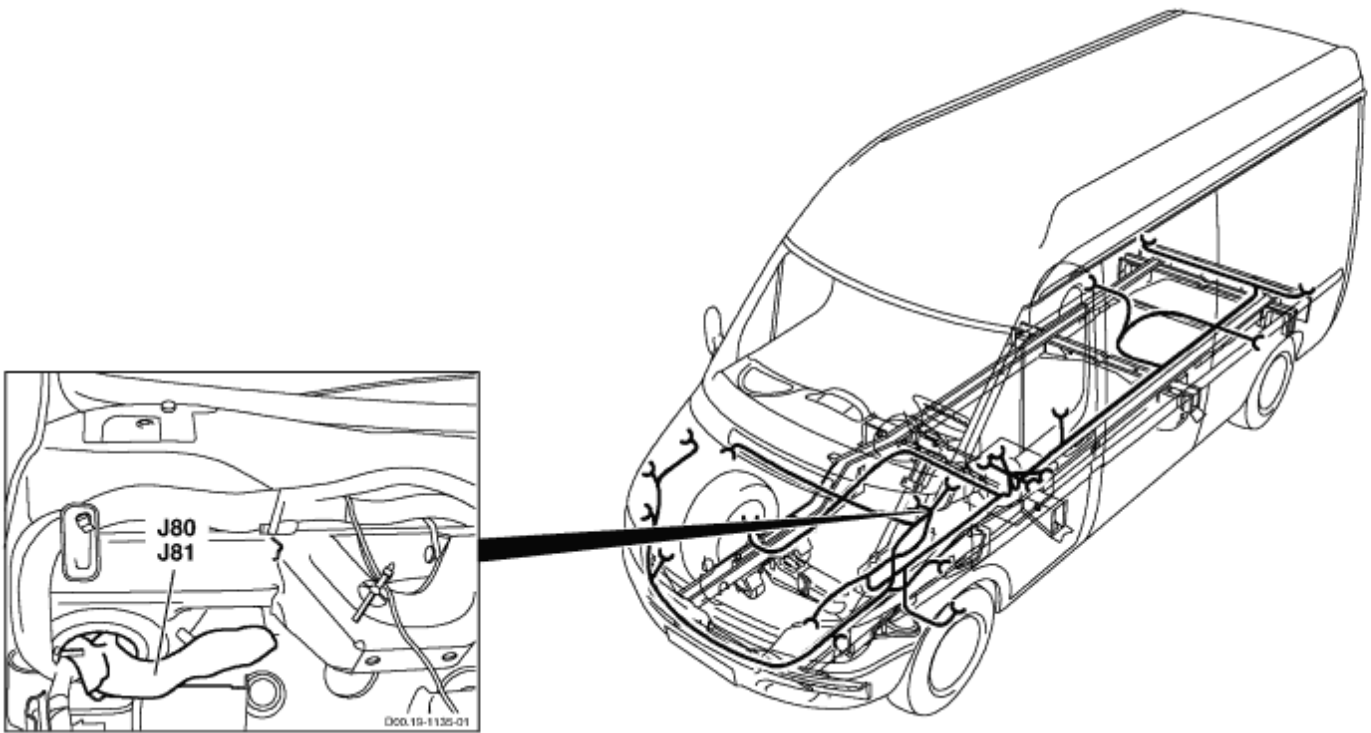

D00.19-1375-09

Terminal block	Designation		Component	Designation	Connector Pin
J80	FWH/waistrail (next to firewall rubber grommet)	→	A12	Electrical center	5.5
	Right turn signal light connector sleeve	→	A82	EDW control unit	1.4

		→	A93	Trailer socket control unit	2.B
		→	E26H3	Right front turn signal lamp	6
		→	E68h4	Right rear turn signal lamp	5
		→	H2	Right front side turn signal lamp (5 W)	1
		→	H9	Right front side turn signal lamp (21 W)	1
		→	K102	Right EDW turn signal lamp relay	1
		→	P15	Instrument cluster	1.7
J81	FWH/waistrail (next to firewall rubber grommet)	→	A12	Electrical center	5.8
	Left turn signal light connector sleeve	→	A62	WSP control unit	8
		→	A82	EDW control unit	1.1
		→	A93	Trailer socket control unit	2.E
		→	E25h21	Left front turn signal lamp	6
		→	E67h22	Left rear turn signal lamp	5
		→	H5	Left front side turn signal lamp (5 W)	1
		→	H10	Left front side turn signal lamp (21 W)	1
		→	K101	Left EDW turn signal lamp relay	1
		→	P15	Instrument cluster	2.13

MODEL XD1, XD2, XD3, XD4, XD5, XD6, XD7, YD1, YD2, YD3, YD4, YD5, YD6, YD7, WD1, WD2, WD3, WD6, WD7

MODEL 903.61 /66 /67, 904.61 /66 with CODE (ZU7) National version for Canada

MODEL 903.66 /67, 904.61 /66 with CODE (ZU8) National version for USA

MODEL 903.61 /62 /66 /67, 904.61 /62 /66 with CODE (ZU9) National version for Mexico

<p>PE31.19-D-2000G</p>	<p>Wiring diagram trailer hitch</p>	<p>MODEL XD1##, XD2##, XD3##, XD4##, XD5##, XD6##, XD7##, YD1##, YD2##, YD3##, YD4##, YD5##, YD6##, YD7##, WD1##, WD2##, WD3##, WD6##, WD7## ### up to 649051 up to 31.3.04 MODEL 903.61# /66# /67#, 904.61# /66# ## up to 649051 up to 31.3.04 with CODE (E58) electrical system for trailer socket with CODE (ZU7) national version for Canada MODEL 903.61# /66# /67#, 904.61# /66# ## up to 649051 up to 31.3.04 with CODE (E58) electrical system for trailer socket with CODE (ZU8) national version for USA MODEL 903.61# /62# /66# /67#, 904.61# /62# /66# ## up to 649051 up to 31.3.04 with CODE (E58) electrical system for trailer socket with CODE (ZU9) national version for Mexico</p>	<p>PE31.19-D-2000G</p>
<p>PE31.19-D-2000H</p>	<p>Wiring diagram trailer hitch</p>	<p>MODEL XD1##, XD2##, XD3##, XD4##, XD5##, XD6##, XD7##, YD1##, YD2##, YD3##, YD4##, YD5##, YD6##, YD7##, WD1##, WD2##, WD3##, WD6##, WD7## ### as of 649052 as of 1.4.04 MODEL 903.61# /66# /67#,</p>	<p>PE31.19-D-2000H</p>

	<p>904.61# /66# ## as of 649052 as of 1.4.04 with CODE (E58) electrical system for trailer socket with CODE (ZU7) national version for Canada MODEL 903.61# /66# /67#, 904.61# /66# ## as of 649052 as of 1.4.04 with CODE (E58) electrical system for trailer socket with CODE (ZU8) national version for USA MODEL 903.61# /62# /66# /67#, 904.61# /62# /66# ## as of 649052 as of 1.4.04 with CODE (E58) electrical system for trailer socket with CODE (ZU9) national version for Mexico</p>	
--	--	--

MODEL XD1, XD2, XD3, XD4, XD5, XD6, XD7, YD1, YD2, YD3, YD4, YD5, YD6, YD7, WD1, WD2, WD3, WD6, WD7

MODEL 903.61 /66 /67, 904.61 /66 with CODE (ZU7) National version for Canada

MODEL 903.61 /66 /67, 904.61 /66 with CODE (ZU8) National version for USA

MODEL 903.61 /62 /66 /67, 904.61 /62 /66 with CODE (ZU9) National version for Mexico

PE80.20-D-2000F	Wiring diagram of central locking (CL)	<p>MODEL XD1, XD2, XD3, XD4, XD5, XD6, XD7, YD1, YD2, YD3, YD4, YD5, YD6, YD7, WD1, WD2, WD3, WD6, WD7</p> <p>MODEL 903.61 /66 /67, 904.61 /66 with CODE (FY6) Central locking with radio remote control with CODE (ZU7) National version for Canada</p> <p>MODEL 903.61 /66 /67, 904.61 /66 with CODE (FY6) Central locking with radio remote control with CODE (ZU8) National version for USA</p> <p>MODEL 903.61 /62 /66 /67, 904.61 /62 /66 with CODE (FY6) Central locking with radio remote control with CODE (ZU9) National version for Mexico</p>	PE80.20-D-2000F
PE80.35-D-2200C	Wiring diagram of remote central locking with immobilizer and transponder	<p>MODEL XD1, XD2, XD3, XD4, XD5, XD6, XD7, YD1, YD2, YD3, YD4, YD5, YD6, YD7, WD1, WD2, WD3, WD6, WD7</p> <p>MODEL 903.61 /66 /67, 904.61 /66 with CODE (ZU7) National version for Canada</p> <p>MODEL 903.61 /66 /67, 904.61 /66 with CODE (ZU8) National version for USA</p> <p>MODEL 903.61 /62 /66 /67, 904.61 /62 /66</p>	PE80.35-D-2200C

		with CODE (ZU9) National version for Mexico	
PE80.50-D-2000D	Wiring diagram of anti-theft alarm system (ATA)	<p>MODEL XD1, XD2, XD3, XD4, XD5, XD6, XD7, YD1, YD2, YD3, YD4, YD5, YD6, YD7, WD1, WD2, WD3, WD6, WD7</p> <p>MODEL 903.61 /66 /67, 904.61 /66</p> <p>with CODE (FY1) Anti-theft alarm system with interior motion sensor, towing sensor and battery-operated horn</p> <p>with CODE (ZU7) National version for Canada</p> <p>MODEL 903.61 /66 /67, 904.61 /66</p> <p>with CODE (FY1) Anti-theft alarm system with interior motion sensor, towing sensor and battery-operated horn</p> <p>with CODE (ZU8) National version for USA</p>	PE80.50-D-2000D

PE82.30-D-2000-99D

[Display in a separate window](#)

To display wiring diagrams, you need a
JAVA 1.1 capable Browser like e.g. "Microsoft Internet Explorer 4.0"
or
"Netscape Navigator 4.05" and higher with AWT 1.1 support

A12	Electrical center
A12k2	Wiper relay
A12n1	Wipers, turn signals, engine start control module
J250	Wiper switch connector sleeve
M6	Windscreen washer system pump
M7	Windscreen wiper motor, LHD
M7x1	Connector for LHD windshield wiper motor
M9	Windscreen wiper motor, RHD
M9x1	Connector for RHD windshield wiper motor
S2	Combination switch
S2s6	Washer pushbutton
S2s7	Wiper switch
W2	Ground point right headlamp
W4	Ground point firewall

PE82.30-D-2000-60D	Legend for wiring diagram of windshield wiper	<p>Model XD1, XD2, XD3, XD4, XD5, XD6, XD7, YD1, YD2, YD3, YD4, YD5, YD6, YD7, WD1, WD2, WD3, WD6, WD7</p> <p>Models 903.61 /66 /67, 904.61 /66 with CODE (ZU7) Canada national version</p> <p>Models 903.61 /66 /67, 904.61 /66 with CODE (ZU8) USA national version</p> <p>Models 903.61 /62 /66 /67, 904.61 /62 /66 with CODE (ZU9) Mexico national version</p>	
--------------------	---	--	--

Code	Designation	Coordinate
A12	Electrical center	6F
A12k2	Wiper relay	13C
A12n1	Wipers, turn signals, engine start control module	11C
J250	Wiper switch connector sleeve	11L
M6	Windscreen washer system pump	12L
M7	Windscreen wiper motor LHS	3L
M7x1	Connector for LHD windshield wiper motor	2J
M9	Windscreen wiper motor RHS	3L
M9x1	Connector for RHD windshield wiper motor	2J
S2	Combination switch	10A
S2s6	Washer pushbutton	8B
S2s7	Wiper switch	9B
W2	Ground point right headlamp	13H
W4	Firewall ground point	1L

PE82.30-D-2000-99F

[Display in a separate window](#)

To display wiring diagrams, you need a
JAVA 1.1 capable Browser like e.g. "Microsoft Internet Explorer 4.0"
or
"Netscape Navigator 4.05" and higher with AWT 1.1 support

A66	Rain sensor control module
A66	Rain sensor control module
B137	Rain sensor
J250	Wiper switch connector sleeve
J477	Connector sleeve for screening of jacket line for rain sensor
J478	Connector sleeve for screening of jacket line for rain sensor
M6	Windscreen washer system pump
M7	Windscreen wiper motor, LHD
M7x1	Connector for LHD windshield wiper motor
W2	Ground point right headlamp
W4	Ground point firewall
W5	Ground point seat frame
W42	Ground point for screening of jacket line for rain sensor
W43	Ground point for screening of jacket line for rain sensor
X235	Rain sensor connector
X240	Frame/roof connector

PE82.30-D-2000-60F	windshield wiper	<p>MODEL XD1, XD2, XD3, XD4, XD5, XD6, XD7, YD1, YD2, YD3, YD4, YD5, YD6, YD7, WD1, WD2, WD3, WD6, WD7</p> <p>MODEL 903.61 /66 /67, 904.61 /66</p> <p>with CODE (FM2) tinted windshield, heated with rain sensor</p> <p>with CODE (ZU7) National version for Canada</p> <p>MODEL 903.61 /66 /67, 904.61 /66</p> <p>with CODE (FM2) tinted windshield, heated with rain sensor</p> <p>with CODE (ZU8) National version for USA</p> <p>MODEL 903.61 /62 /66 /67, 904.61 /62 /66</p> <p>with CODE (FM2) tinted windshield, heated with rain sensor</p> <p>with CODE (ZU9) National version for Mexico</p>	
--------------------	------------------	--	--

Code	Designation	Coordinate
A66	Rain sensor control unit	4A 11A
B137	Rain sensor	3L
J250	Wiper switch connector sleeve	8G
J477	Rain sensor sheathed line shielding connector sleeve	1G
J478	Rain sensor sheathed line shielding connector sleeve	4G
M6	Windscreen washer system pump	9L
M7	Windscreen wiper motor LHD	7L
M7x1	Connector for LHD windshield wiper motor	5J
W2	Ground point right headlamp	10H
W4	Firewall ground point	6G
W5	Seat frame ground point	1E
W42	Rain sensor sheathed line screening ground point	1L
W43	Rain sensor sheathed line screening ground point	5L

X235	Rain sensor connector	2H
X240	Frame/roof connector	2E

PE82.10-D-2400-99C

[Display in a separate window](#)

To display wiring diagrams, you need a
JAVA 1.1 capable Browser like e.g. "Microsoft Internet Explorer 4.0"
or
"Netscape Navigator 4.05" and higher with AWT 1.1 support

A12	Electrical center
E2	Left front side marker lamp
E3	Right front side marker lamp
E13	Left center side marker light
E14	Right center side marker lamp
E15	Left rear side-marker lamp
E16	Right rear side-marker lamp
E28	Left front side marker lamp
E75	License plate lighting
E76	License plate lighting
E101	Right front side marker lamp
J22	Circuit 15, fused, connector sleeve
J33	Circuit 58 connector sleeve
J46	Terminal 58 connector sleeve
J144	Side marker light connector sleeve
J145	Side marker light connector sleeve
J446	Circuit 58 connector sleeve
W5	Ground point seat frame
W5	Ground point seat frame
W5	Ground point seat frame
W5	Ground point seat frame
W6	Ground point taillamp
W6	Ground point taillamp

- X26 Left rear license plate lighting contact plate, 2-pin
- X79 Frame/waistrail connector
- X119 Side marker lamp connector

PE82.10-D-2400-60C	Legend for wiring diagram of side marker/body outline lights	<p>Model XD1, XD2, XD3, XD4, XD5, XD6, XD7, YD1, YD2, YD3, YD4, YD5, YD6, YD7, WD1, WD2, WD3, WD6, WD7</p> <p>Models 903.61 /66 /67, 904.61 /66 with CODE (LB1) side-marker lamp with CODE (ZU7) Canada national version</p> <p>Models 903.61 /66 /67, 904.61 /66 with CODE (LB1) side-marker lamp with CODE (ZU8) USA national version</p> <p>Models 903.61 /62 /66 67, 904.61 62 /66 with CODE (LB1) side-marker lamp with CODE (ZU9) Mexico national version</p>	
--------------------	--	---	--

Code	Designation	Coordinate
A12	Electrical center	17L
E2	Left front side marker lamp	8L
E3	Right front side marker lamp	11L
E13	Left center side marker lamp	10L
E14	Right center side marker lamp	12L
E15	Left rear side marker lamp	14L
E16	Right rear side marker lamp	15L
E28	Left front side marker lamp	7L
E75	License plate lighting	1L
E76	License plate lighting	3L
E101	Right front side marker lamp	4L
J22	Circuit 15 fused connector sleeve	19L
J33	Circuit 58 connector sleeve	16G
J46	Circuit 58 connector sleeve	20L
J144	Side marker light connector sleeve	7G
J145	Side marker light connector sleeve	13H

J446	Circuit 58 connector sleeve	7E
W5	Seat frame ground point	4H 7H 9H 12H
W6	Ground point taillamp	2C 15H
X26	Left rear license plate lighting contact plate 2-pin	2E
X79	Frame/waistrail connector	19G
X119	Side marker lamp connector	6L

GF00.19-D-3100-59B

Arrangement and assignment of terminal block connectors side marker/body outline lamps

Models XD1, XD2, XD3, XD4, XD5, XD6, XD7, YD1, YD2, YD3, YD4, YD5, YD6, YD7, WD1, WD2, WD3, WD6, WD7
Models 903.61/66/67, 904.61/66
with code (LB1) Side-marker lamps
with code (ZU7) National version for Canada
Models 903.61/66/67, 904.61/66
with code (LB1) Side-marker lamps
with code (ZU8) National version for USA
Models 903.61/62/66/67, 904.61/62/66
with code (LB1) Side-marker lamps
with code (ZU9) National version for Mexico

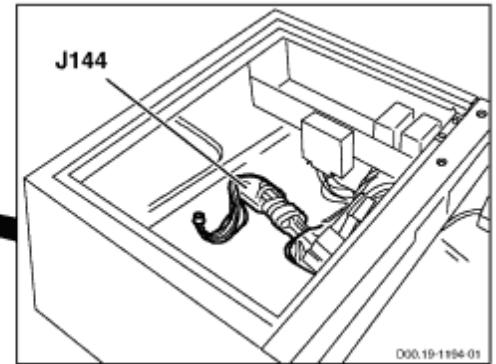
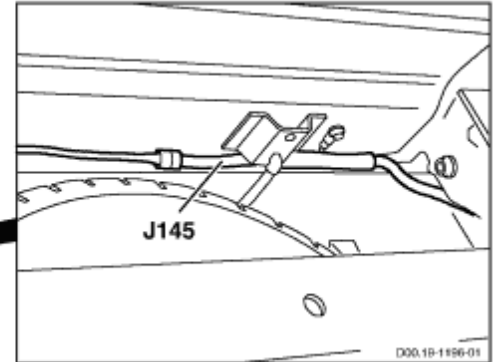
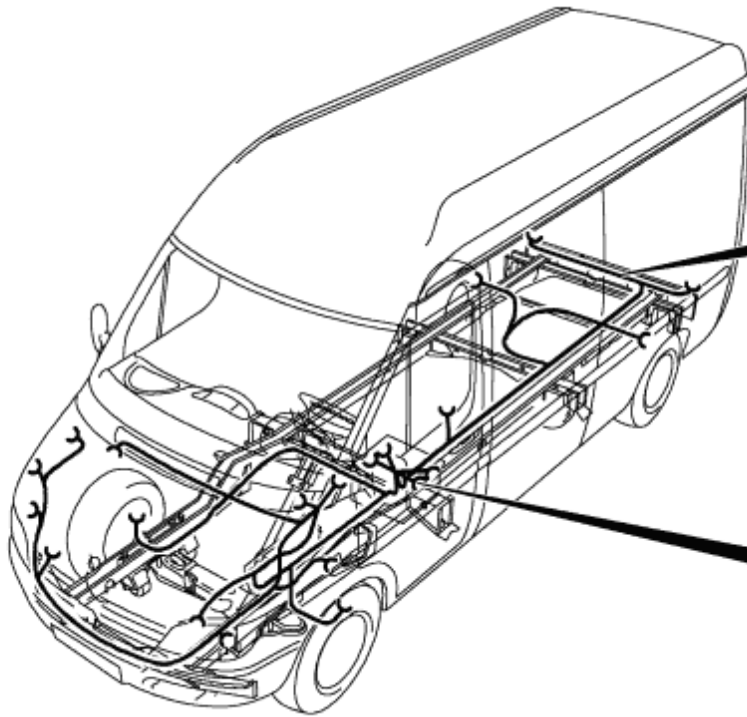

D00.19-1376-09

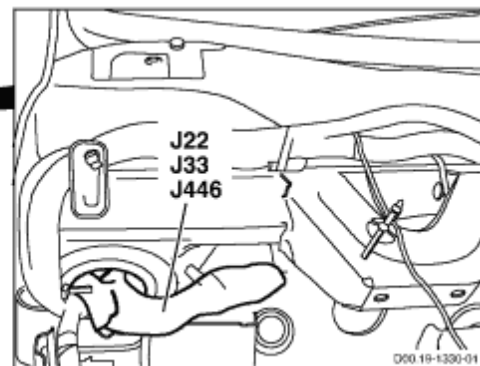
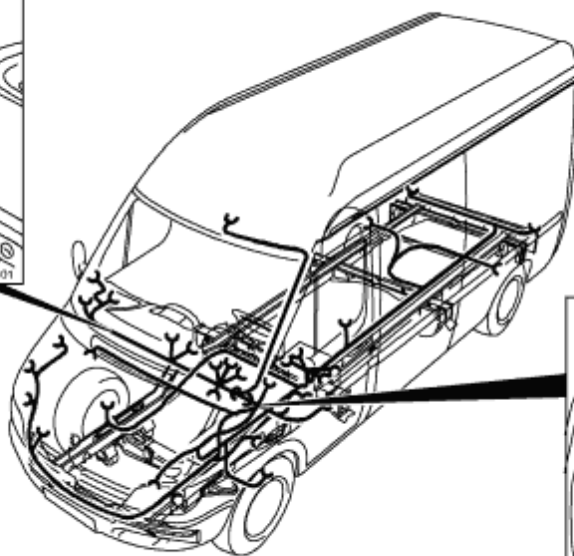
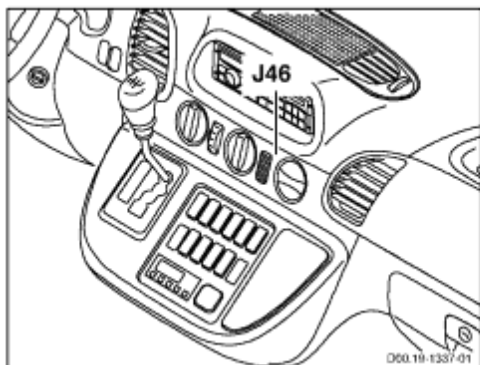

D00.19-1377-09

Terminal block	Designation		Component	Designation	Connector Pin
J22	FWH/waistrail (next to firewall rubber grommet)	→	A12	Electrical center	4.7
	Circuit 15 fused connector sleeve	→	A62	WSP control unit	7
		→	H17	Horn	2
		→	K37	Horn relay	4
		→	K70	Circuit 15 relay for optional equipment	2
		→	K103	Circulation pump relay	3
		→	K138	Circuit 15 relay	2
		→	X79	Frame/waistrail connector	1
		→	X80	Frame/waistrail connector	3
J33	FWH/waistrail (next to firewall rubber grommet)	→	A12	Electrical center	5.7
	Circuit 58 connector sleeve	→	J446	Circuit 58 connector sleeve	
		→	K140	Daytime running lamps circuit 58 relay	3
		→	X79	Frame/waistrail connector	2

J46	WWH (middle of instrument panel)	→	A9	Radio	1.A6
	Circuit 58 connector sleeve	→	A40	EWM control unit	2
		→	A71	Heater timer	1
		→	A81	Air conditioning pushbutton control and operating unit	1.9
		→	E104	Ashtray lighting	1
		→	S12	Driver seat heater switch	1
		→	S25	Headlamp range adjustment switch	9
		→	S48	ASR switch	1
		→	S57	Differential lock switch	1
		→	S81	Rear window defroster pushbutton	1
		→	S85	Driver interior lighting pushbutton	1
		→	S87	Auxiliary heater switch	1
		→	S90	Roof fan switch	1
		→	S92	Panic alarm button	1
		→	S99	ATA [EDW] towing/interior motion sensor button	1
		→	S100	Additional heat exchanger double-contact pushbutton	1
		→	S107	Front passenger seat heater switch	1
		→	S119.1	Fog light switch	1
		→	S124	Reading lamp switch	1
		→	S126	Interior pushbutton	1
		→	S137	Roof AC switch	1
		→	S138	Temperature switch	9
		→	X79	Frame/waistrail connector	2
		→	X234	Cigar lighter illumination plug connection	3
J144	FWH/seat frame (behind rubber grommet)	→	E2	Left front side marker lamp	1
	Side marker light connector sleeve	→	E3	Right front side marker lamp	1
		→	E13	Left center side marker lamp	1
		→	E14	Right center side marker lamp	1
		→	E28	Left front side marker lamp	1
		→	E101	Right front side marker lamp	1

		→	J145	Side marker light connector sleeve	
		→	J446	Circuit 58 connector sleeve	
		→	X119	Side marker lamp connector	2
J145	FWH (close to ground point W6)	→	E15	Left rear side marker lamp	1
	Side marker light connector sleeve	→	E16	Right rear side marker lamp	1
		→	J144	Side marker light connector sleeve	
		→	J446	Circuit 58 connector sleeve	
J446	FWH/waistrail (next to firewall rubber grommet)	→	E25	Left headlamp	1
	Circuit 58 connector sleeve	→	E26	Right headlamp	1
		→	J33	Circuit 58 connector sleeve	
		→	J144	Side marker light connector sleeve	
		→	J145	Side marker light connector sleeve	
		→	K140	Daytime running lamps circuit 58 relay	3 5
		→	P15	Instrument cluster	2.7
		→	X26	Left rear license plate lighting contact plate 2-pin	1
		→	X45	Frame/roof connector (standard)	3 4

PE54.35-D-2000-99D

[Display in a separate window](#)

To display wiring diagrams, you need a
JAVA 1.1 capable Browser like e.g. "Microsoft Internet Explorer 4.0"
or
"Netscape Navigator 4.05" and higher with AWT 1.1 support

A12 Electrical center
A12 Electrical center
A12f7 Horn, rear window
defroster, circuit 15
relay fuse
H17 Horn
J22 Circuit 15, fused,
connector sleeve
J22 Circuit 15, fused,
connector sleeve
K37 Horn relay
R5 Airbag clock spring
contact
S21 Horn switch
S53 Steering lock with
mechanical repeat
start lockout
W4 Ground point
firewall
W5 Ground point seat
frame
X113 Main wiring
harness/airbag
clock spring contact
connector

PE54.35-D-2000-60D	Legend for wiring diagram of signal system	<p>MODEL XD1, XD2, XD3, XD4, XD5, XD6, XD7, YD1, YD2, YD3, YD4, YD5, YD6, YD7, WD1, WD2, WD3, WD6, WD7</p> <p>MODEL 903.61 /66 /67, 904.61 /66 with CODE (ZU7) National version Canada</p> <p>MODEL 903.61 /66 /67, 904.61 /66 with CODE (ZU8) National version USA</p> <p>MODEL 903.61 /62 /66 /67, 904.61 /62 /66 with CODE (ZU9) National version Mexico</p>	
--------------------	--	---	--

Code	Designation	Coordinate
A12	Electrical center	5A 10A
A12f7	Horn, rear window defroster, circuit 15 relay fuse	6A
H17	Horn	8L
J22	Circuit 15 fused connector sleeve	5E 7L
K37	Horn relay	5L
R5	Clock spring contact	1J
S21	Horn switch	1G
S53	Steering lock with mechanical repeat start lockout	10L
W4	Firewall ground point	4G
W5	Seat frame ground point	6G
X113	Horn clock spring contact connector	3J

GF00.19-D-3100-25C	Arrangement and assignment of terminal block connectors signal system	<p>Models XD1, XD2, XD3, XD4, XD5, XD6, XD7, YD1, YD2, YD3, YD4, YD5, YD6, YD7, WD1, WD2, WD3, WD6, WD7</p> <p>Models 903.61/66/67, 904.61/66 with code (ZU7) National version for Canada</p> <p>Models 903.61/66/67, 904.61/66 with code (ZU8) National version for USA</p> <p>Models 903.61/62/66/67, 904.61/62/66 with code (ZU9) National version for Mexico</p>	
--------------------	---	--	--

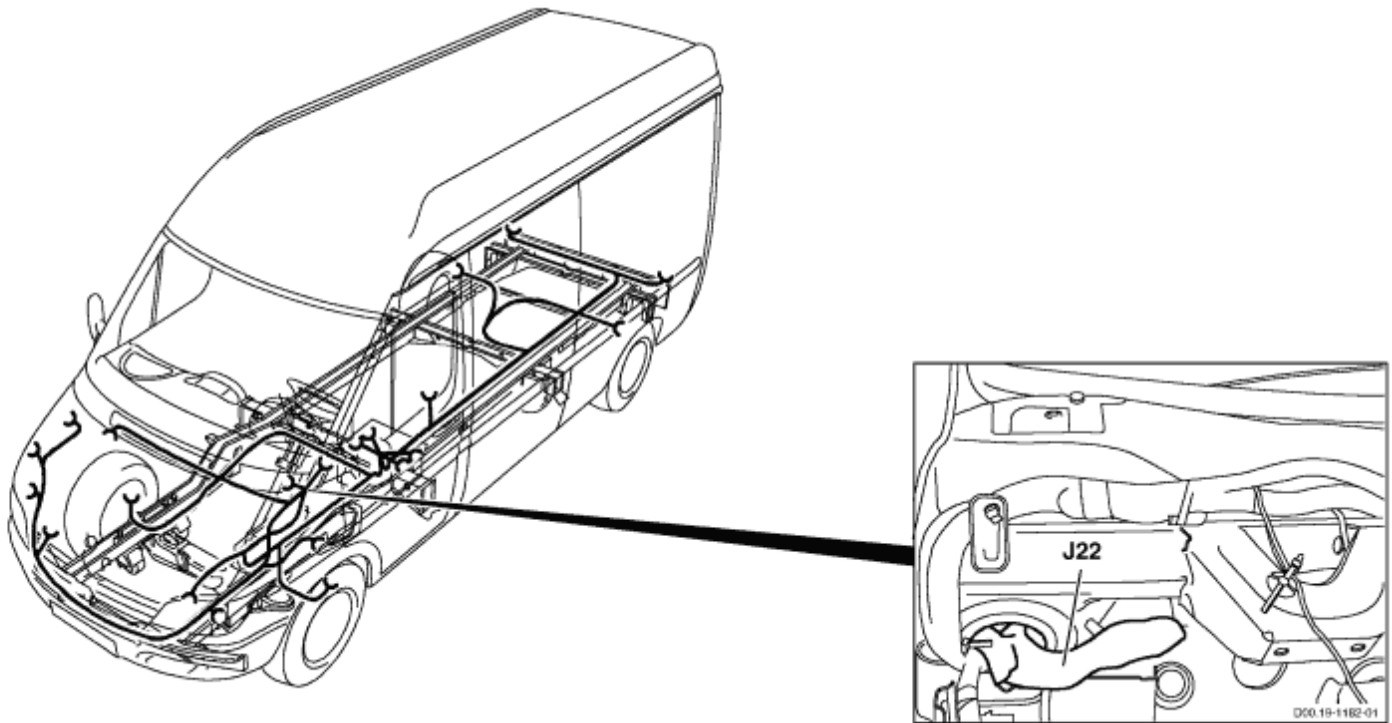

D00.19-1366-09

Terminal block	Designation		Component	Designation	Connector Pin
J22	FWH/waistrail (next to firewall rubber grommet)	→	A12	Electrical center	4.7
	Circuit 15 fused connector sleeve	→	A62	WSP control unit	7

		→	H17	Horn	2
		→	K37	Horn relay	4
		→	K70	Circuit 15 relay for optional equipment	2
		→	K103	Circulation pump relay	3
		→	K138	Circuit 15 relay	2
		→	X79	Frame/waistrail connector	1
		→	X80	Frame/waistrail connector	3

PE91.30-D-2000-99D

[Display in a separate window](#)

To display wiring diagrams, you need a
JAVA 1.1 capable Browser like e.g. "Microsoft Internet Explorer 4.0"
or
"Netscape Navigator 4.05" and higher with AWT 1.1 support

F128 Driver/front
passenger seat
heater fuse (15 A)
J107 Circuit 15 connector
sleeve (seat heater)
J108 Circuit 15 connector
sleeve (seat heater)
J31 Circuit 15, fused,
connector sleeve
J379 Circuit 15, fused,
connector sleeve
J41 Seat heater
connector sleeve
J42 Seat heater
connector sleeve
J46 Circuit 58 connector
sleeve
R30 Left seat heater
R31 Right seat heater
S107 Front passenger
seat heater switch
S12 Driver seat heater
switch
W5 Ground point seat
frame
W5 Ground point seat
frame
W8 Ground point
waistrail
X81 Frame/waistrail plug
connection
X81 Frame/waistrail plug
connection
X81 Frame/waistrail plug
connection
X81 Frame/waistrail plug
connection



PE91.30-D-2000-60D	Legend of wiring diagram heated seats (HS)	<p>MODEL XD1, XD2, XD3, XD4, XD5, XD6, XD7, YD1, YD2, YD3, YD4, YD5, YD6, YD7, WD1, WD2, WD3, WD6, WD7</p> <p>MODELS 903.61 /66/ 67, 904.61/66 with CODE (H15) Heater for front passenger seat with CODE (H16) Heater for driver seat with CODE (ZU7) National version Canada</p> <p>MODELS 903.61 /66/ 67, 904.61/66 with CODE (H15) Heater for front passenger seat with CODE (H16) Heater for driver seat with CODE (ZU8) National version USA</p>	
--------------------	--	---	--

Code	Designation	Coordinate
F128	Driver/front passenger seat heater fuse (15 A)	4J
J31	Circuit 15 fused connector sleeve	4L
J41	Seat heater connector sleeve	2G
J42	Seat heater connector sleeve	10G
J46	Circuit 58 connector sleeve	6E
J107	Circuit 15 connector sleeve (seat heater)	4E
J108	Circuit 15 connector sleeve (seat heater)	9E
J379	Circuit 15 fused connector sleeve	6L
R30	Left seat heater	2L
R31	Right seat heater	11L
S12	Driver seat heater switch	4A
S107	Front passenger seat heater switch	10A
W5	Seat frame ground point	3G 10G
W8	Ground point waistrail	6H
X81	Frame/waistrail connector	1E 4H 8H 10E



GF00.19-D-3100-50C

Arrangement and assignment of terminal block connectors heated seats (HS)

Models XD1, XD2, XD3, XD4, XD5, XD6, XD7, YD1, YD2, YD3, YD4, YD5, YD6, YD7, WD1, WD2, WD3, WD6, WD7
Models 903.61/66/67, 904.61/66
with code (H15) Heater for front passenger seat
with code (H16) Heater for driver seat
with code (ZU7) National version for Canada
Models 903.61/66/67, 904.61/66
with code (H15) Heater for front passenger seat
with code (H16) Heater for driver seat
with code (ZU8) National version for USA

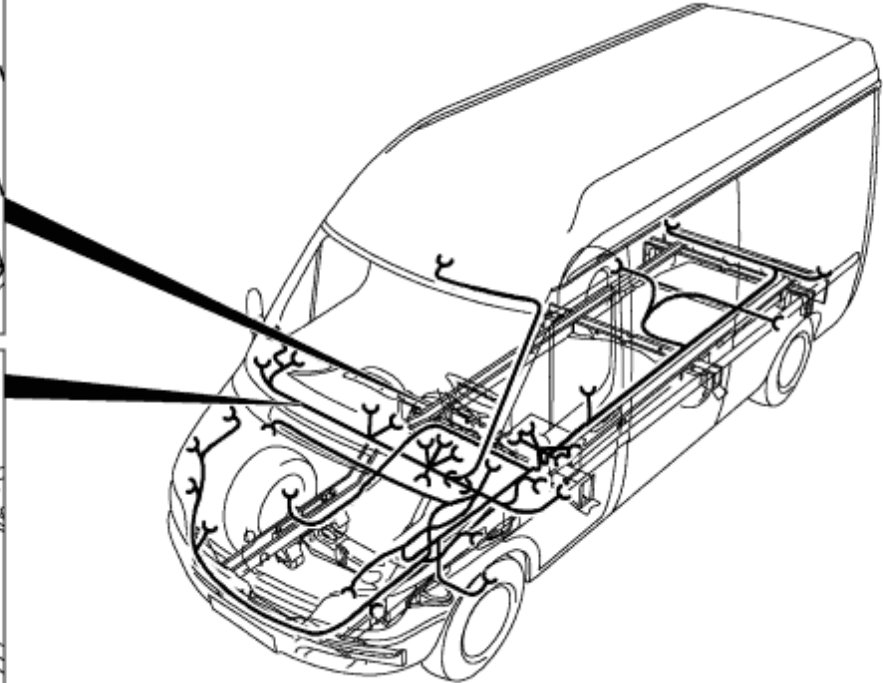
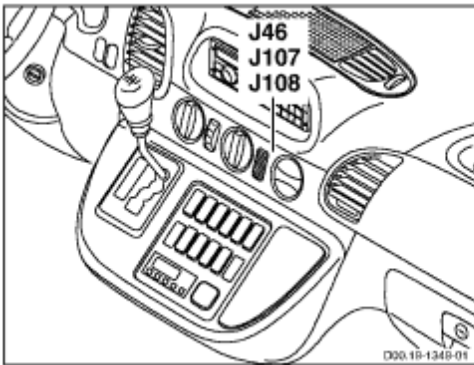
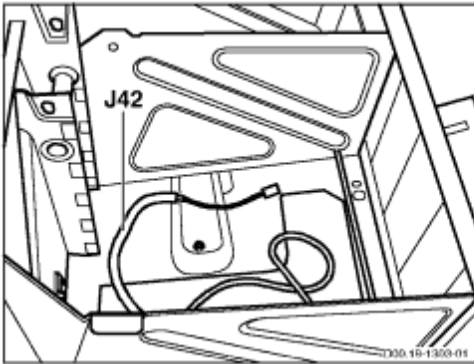

D00.19-1392-09

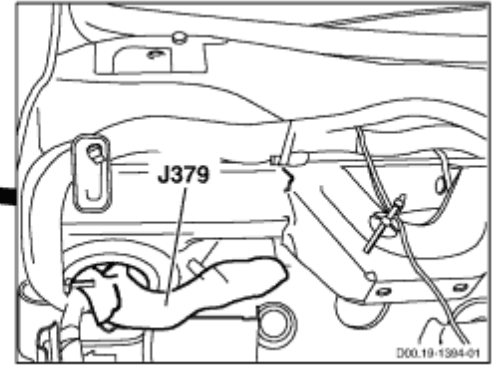
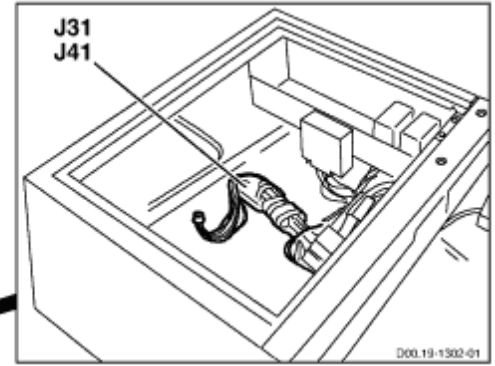
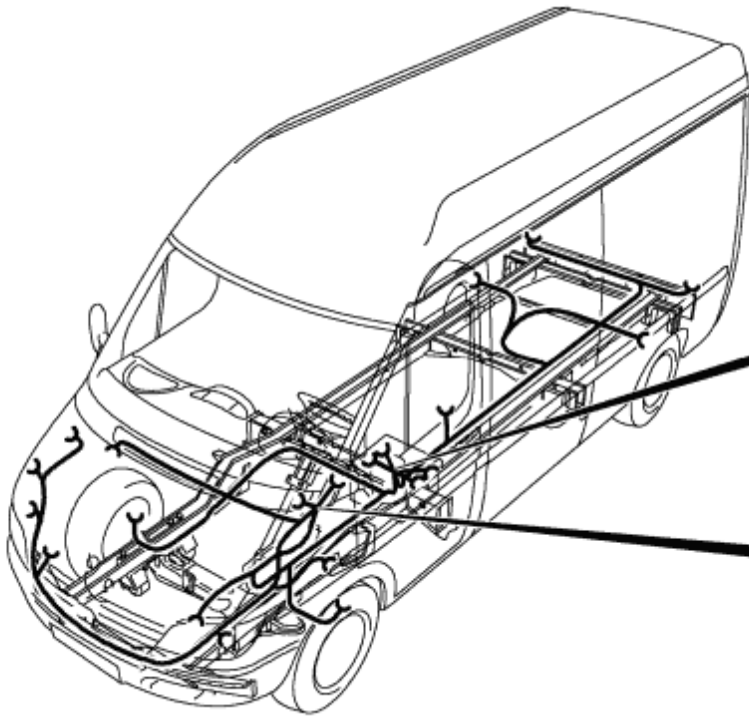

D00.19-1393-09

Terminal block	Designation		Component	Designation	Connector Pin
J31	FWH/seat frame (behind rubber grommet)	→	F5	ABS terminal 15 fuse	1
	Circuit 15 fused connector sleeve	→	F52	Front passenger door power window fuse (25 A)	1
		→	F53	Driver door power window fuse (25 A)	1
		→	F54	Heated and adjustable exterior mirror fuse (10 A)	1
		→	F86	EDW circuit 15 fuse (7.5 A)	1
		→	F127	Differential lock fuse (15 A)	1
		→	F128	Driver, passenger seat heater fuse (15 A)	1
		→	F139	Additional heater fuse (10 A)	1
		→	F150	Roof fan fuse (15 A)	1
		→	K70	Circuit 15 relay for optional equipment	1
J41	FWH/seat frame (close to R30)	→	R30	Left seat heater	2 3

	Seat heater connector sleeve	→	X81	Frame/waistrail connector	4
J42	FWH/front passenger seat frame (close to R31)	→	R31	Right seat heater	2 3
	Seat heater connector sleeve	→	X81	Frame/waistrail connector	6
J46	WWH (middle of instrument panel)	→	A9	Radio	1.A6
	Circuit 58 connector sleeve	→	A40	EWM control unit	2
		→	A71	Heater timer	1
		→	A81	Air conditioning pushbutton control and operating unit	1.9
		→	E104	Ashtray lighting	1
		→	S12	Driver seat heater switch	1
		→	S25	Headlamp range adjustment switch	9
		→	S48	ASR switch	1
		→	S57	Differential lock switch	1
		→	S81	Rear window defroster pushbutton	1
		→	S85	Driver interior lighting pushbutton	1
		→	S87	Auxiliary heater switch	1
		→	S90	Roof fan switch	1
		→	S92	Panic alarm button	1
		→	S99	ATA [EDW] towing/interior motion sensor button	1
		→	S100	Additional heat exchanger double-contact pushbutton	1
		→	S107	Front passenger seat heater switch	1
		→	S119.1	Fog light switch	1
		→	S124	Reading lamp switch	1
		→	S126	Interior pushbutton	1
		→	S137	Roof AC switch	1
		→	S138	Temperature switch	9
		→	X79	Frame/waistrail connector	2
		→	X234	Cigar lighter illumination plug connection	3
J107	WWH (middle of instrument panel)	→	S12	Driver seat heater switch	3 8
	Circuit 15 connector sleeve (seat heater)	→	X81	Frame/waistrail connector	5

J108	WWH (middle of instrument panel)	→	S107	Front passenger seat heater switch	3 8
	Circuit 15 connector sleeve (seat heater)	→	X81	Frame/waistrail connector	8
J379	FWH/waistrail (next to firewall rubber grommet)	→	F128	Driver/front passenger seat heater fuse (15 A)	2
	Circuit 15 fused connector sleeve	→	X81	Frame/waistrail connector	5 8

PE15.00-D-2000-99R

[Display in a separate window](#)

To display wiring diagrams, you need a
JAVA 1.1 capable Browser like e.g. "Microsoft Internet Explorer 4.0"
or
"Netscape Navigator 4.05" and higher with AWT 1.1 support

A12	Electrical center
A80	CDI control module
A80	CDI control module
B16	Coolant temperature sensor
D4	Glow time output stage
D4	Glow time output stage
F70	D+ relay fuse (15 A)
F140	Fuse box
F140.1	Circuit 30 fuse (200 A)
F140.2	Circuit 30 fuse (70 A)
F140.3	Circuit 30 fuse (125 A)
F140.4	Circuit 30 fuse (80 A)
F140.5	Circuit 30 fuse (125 A)
F140.6	Circuit 30 fuse (100 A)
G1	Alternator
G2	Battery
J16	Circuit 30 connector sleeve
J18	Circuit 15, fused, connector sleeve
J19	Circuit 61 connector sleeve
J22	Circuit 15, fused, connector sleeve
J31	Terminal 15 connector sleeve, fused
J89	Circuit 56b connector sleeve
J312	Circuit 30 connector sleeve
J352	Circuit 50

	connector sleeve
J421	CAN-low connector sleeve
J422	CAN-high connector sleeve
K26	Circuit D+ relay
K61	Starter relay
K70	Circuit 15 relay, for SA
M1	Starter
P15	Instrument cluster
P15	Instrument cluster
R13	Glow plug
R14	Glow plug
R15	Glow plug
R16	Glow plug
R17	Glow plug
S53	Steering lock with mechanical repeat start lockout
W4	Ground point firewall
W5	Ground point seat frame
W5	Ground point seat frame
W5	Ground point seat frame
W7	Ground point (engine compartment)
X195	Frame/engine connector
X209	Engine/Generator connector

PE15.00-D-2000-60R	Legend of wiring diagram starter, alternator	<p>ENGINE 612.981 in MODEL XD1, XD2, XD3, XD4, XD5, XD6, XD7, YD1, YD2, YD3, YD4, YD5, YD6, YD7, WD1, WD2, WD3, WD6, WD7</p> <p>ENGINE 612.981 in MODEL 903.61 /66 /67, 904.61 /66 with CODE (ZU7) National version Canada</p> <p>ENGINE 612.981 in MODEL 903.61 /66 /67, 904.61 /66 with CODE (ZU8) National version USA</p> <p>ENGINE 612.981 in MODEL 903.61 /62 /66 /67, 904.61 /62 /66 with CODE (ZU9) National version Mexico</p>	
--------------------	--	---	--

Code	Designation	Coordinate
A12	Electrical center	20A
A80	CDI control unit	21L 26L
B16	Coolant temperature sensor	26A
D4	Glow time output stage	4A 9A
F70	D+ relay fuse (15 A)	6H
F140	Fuse box	10J
F140.1	Circuit 30 fuse (200 A)	12G
F140.2	Circuit 30 fuse (70 A)	11G
F140.3	Circuit 30 fuse (125 A)	10G
F140.4	Circuit 30 fuse (80 A)	13G
F140.5	Circuit 30 fuse (125 A)	11G
F140.6	Circuit 30 fuse (100 A)	12G
G1	Generator	17L
G2	Battery	10L
J16	Circuit 30 connector sleeve	8H
J18	Circuit 15 fused connector sleeve	17E
J19	Circuit 61 connector sleeve	7H
J22	Circuit 15 fused connector sleeve	12E

J31	Circuit 15 fused connector sleeve	13E
J89	Circuit 56b connector sleeve	5H
J312	Circuit 30 connector sleeve	19E
J352	Circuit 50 connector sleeve	20E
J421	CAN-low connector sleeve	23G
J422	CAN-high connector sleeve	24G
K26	Circuit D+ relay	6L
K61	Starter relay	19L
K70	Circuit 15 relay for optional equipment	12A
M1	Starter	15L
P15	Instrument cluster	3L 16A
R13	Glow plug	1E
R14	Glow plug	1E
R15	Glow plug	2E
R16	Glow plug	2E
R17	Glow plug	2E
S53	Steering lock with mechanical repeat start lockout	24A
W4	Firewall ground point	9H
W5	Seat frame ground point	4H 7H 12E
W7	Engine compartment ground point	4H
X195	Frame/engine connector	15H
X209	Engine/alternator connector	17H

<p>GF00.19-D-3100-14C</p>	<p>Arrangement and assignment of terminal block connectors starter, alternator</p>	<p>Engines 612.981, 647.981 in models XD1, XD2, XD3, XD4, XD5, XD6, XD7, YD1, YD2, YD3, YD4, YD5, YD6, YD7, WD1, WD2, WD3, WD6, WD7</p> <p>Engines 612.981, 647.981 in models 903.61/66/67, 904.61/66 with code (E28) Additional 12 V/88 AH battery with code (E36) Cutoff relay with code (ZU7) National version for Canada</p> <p>Engines 612.981, 647.981 in models 903.61/66/67, 904.61/66 with code (E28) Additional 12 V/88 AH battery with code (E36) Cutoff relay with code (ZU8) National version for USA</p> <p>Engines 612.981, 647.981 in models 903.61/62/66/67, 904.61/62/66 with code (E28) Additional 12 V/88 AH battery with code (E36) Cutoff relay with code (ZU9) National version for Mexico</p>	
---------------------------	--	---	--

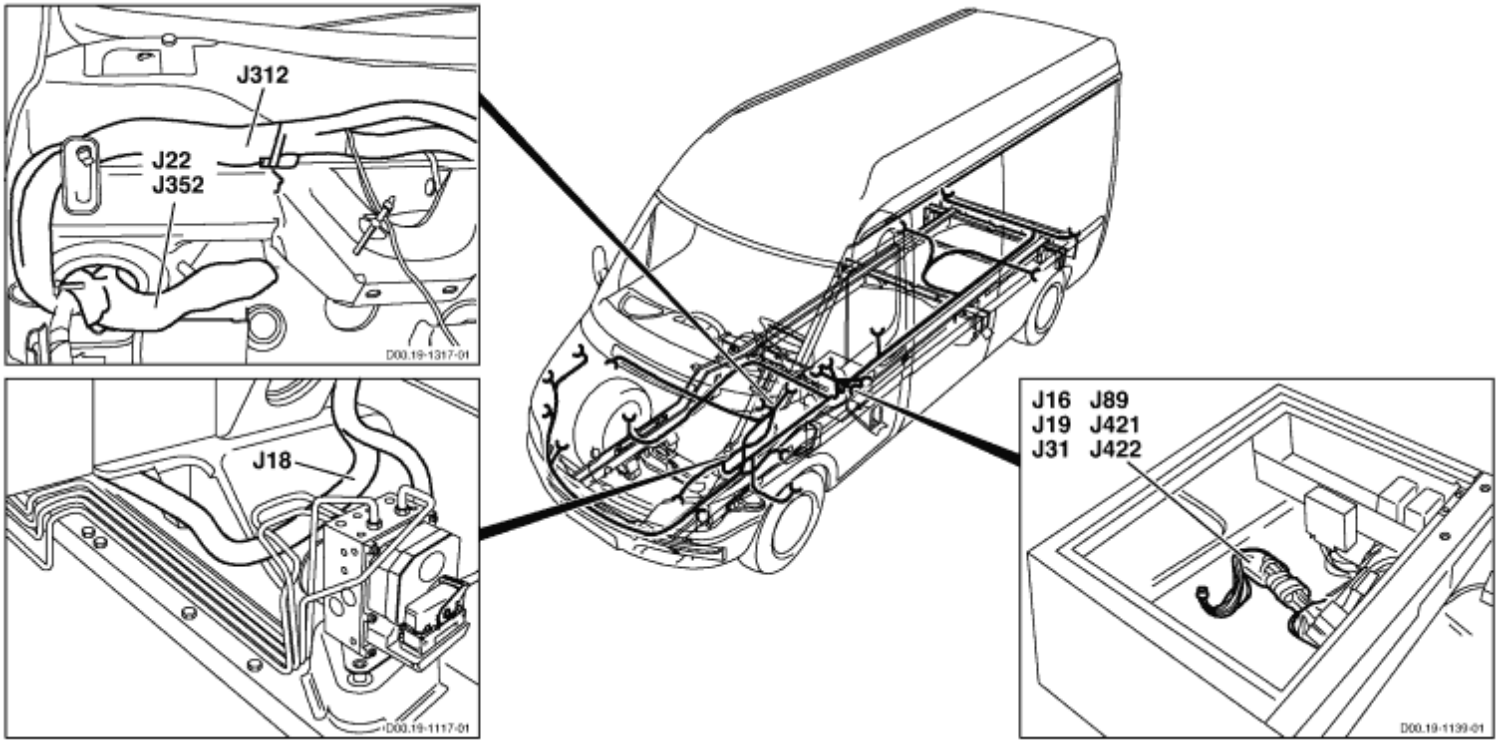

D00.19-1354-09

Terminal block	Designation		Component	Designation	Connector Pin
J16	FWH/seat frame (behind rubber grommet)	→	F6	ABS circuit 30 fuse	1
	Circuit 30 connector sleeve	→	F7	ABS circuit 30 fuse	1
		→	F9	Additional heater fuse (25 A)	1
		→	F11	Instrument cluster fuse (7.5 A)	1
		→	F40	Daytime running lamps fuse	1
		→	F43	Radio remote control fuse (10 A)	1
		→	F44	Central locking fuse (25 A)	1
		→	F62	Interior light fuse (15 A)	1
		→	F63	Heated rear window fuse (30 A)	1
		→	F98	Warm water heater stage 1 blower fuse (10 A)	1
		→	F101	Warm air additional heater fuse (7.5 A)	1
		→	F114	Additional heat exchanger fuse (25 A)	1
		→	F119	Air conditioning additional fan fuse (30 A)	1

		→	F138	Circuit 15 fuse (10 A)	1
		→	F140.3	Circuit 30 fuse (125 A)	2
		→	F143	Additional heater fuse (25 A)	1
		→	F148	Daytime running lamps relay fuse (10 A)	1
		→	F149	Roof AC fuse (40 A)	1
		→	F151	Fog lamp fuse (7.5 A)	1
		→	F153	Trailer socket fuse (25 A)	1
		→	F154	Instrument panel socket fuse (15 A)	1
		→	J327	Circuit 30 unfused connector sleeve	
		→	K26	Circuit D+ relay	1
J18	FWH/engine compartment (behind battery)	→	A10	Airbag control unit	1.5
	Circuit 15 fused connector sleeve	→	A12	Electrical center	4.3
		→	A80	CDI control unit	2.13
		→	K79	Circuit 15 body manufacturer relay	4
		→	P15	Instrument cluster	2.10
J19	FWH/seat frame (behind rubber grommet)	→	A8	Central locking control module	1.8
	Circuit 61 connector sleeve	→	F66	Additional battery isolating relay fuse (15 A)	1
		→	F70	D+ relay fuse (15 A)	2
		→	K3	Heated rear window relay	4
		→	K78	Circuit D+ body manufacturer relay	4
		→	K135	Daytime running lamps terminal 58L relay	2
		→	K136	Daytime running lamps terminal 58R relay	2
		→	K140	Daytime running lamps circuit 58 relay	2
		→	X82	Frame/waistrail connector	13
J22	FWH/waistrail (next to firewall rubber grommet)	→	A12	Electrical center	4.7
	Circuit 15 fused connector sleeve	→	A62	WSP control unit	7
		→	H17	Horn	2
		→	K37	Horn relay	4

		→	K70	Circuit 15 relay for optional equipment	2
		→	K103	Circulation pump relay	3
		→	K138	Circuit 15 relay	2
		→	X79	Frame/waistrail connector	1
		→	X80	Frame/waistrail connector	3
J31	FWH/seat frame (behind rubber grommet)	→	F5	ABS terminal 15 fuse	1
	Circuit 15 fused connector sleeve	→	F52	Front passenger door power window fuse (25 A)	1
		→	F53	Driver door power window fuse (25 A)	1
		→	F54	Heated and adjustable exterior mirror fuse (10 A)	1
		→	F86	EDW circuit 15 fuse (7.5 A)	1
		→	F127	Differential lock fuse (15 A)	1
		→	F128	Driver, passenger seat heater fuse (15 A)	1
		→	F139	Additional heater fuse (10 A)	1
		→	F150	Roof fan fuse (15 A)	1
		→	K70	Circuit 15 relay for optional equipment	1
J89	FWH/seat frame (behind rubber grommet)	→	F41	Daytime running lamps fuse	1
	Circuit 56b connector sleeve	→	F68	Daytime running lamps fuse	1
		→	F70	D+ relay fuse (15 A)	1
		→	K26	Circuit D+ relay	5
J312	FWH/waistrail (behind instrument cluster)	→	A12	Electrical center	8
	Circuit 30 connector sleeve	→	F140.6	Circuit 30 fuse (100 A)	
		→	X218	ATA [EDW] connector	1
J352	FWH/waistrail (next to firewall rubber grommet)	→	A12	Electrical center	3.3
	Circuit 50 connector sleeve	→	A80	CDI control unit	3.20
		→	K61	Starter relay	1
J421	FWH/seat frame (behind rubber grommet)	→	A4	ETC control unit	2.L

	CAN-low connector sleeve	→	A80	CDI control unit	2.12
		→	J378	CAN-low connector sleeve	
J422	FWH/seat frame (behind rubber grommet)	→	A4	ETC control unit	2.H
	CAN-high connector sleeve	→	A80	CDI control unit	2.11
		→	J340	CAN-high connector sleeve	

PE15.00-D-2000-99S

[Display in a separate window](#)

To display wiring diagrams, you need a
JAVA 1.1 capable Browser like e.g. "Microsoft Internet Explorer 4.0"
or
"Netscape Navigator 4.05" and higher with AWT 1.1 support

F66 Additional battery
isolating relay fuse
(15 A)
G2 Battery
G9 Additional battery
J19 Circuit 61 connector
sleeve
K52 Additional battery cut-
off relay
W4 Ground point firewall
W5 Ground point seat
frame

PE15.00-D-2000-60S	Legend of wiring diagram starter, alternator	ENGINE 612.981 in MODEL YD1##, YD2##, YD3##, YD4##, YD5##, WD1##, WD2##, WD3## ### up to 313476 up to 31.8.01 ENGINE 612.981 in MODEL 903.66# /67#, 904.66# ## up to 313476 up to 31.8.01 with CODE (E28) Additional battery 12V/88 AH with CODE (E36) Cutoff relay with CODE (ZU8) National version USA	
--------------------	--	--	--

Code	Designation	Coordinate
F66	Additional battery isolating relay fuse (15 A)	4H
G2	Battery	6A
G9	Additional battery	1L
J19	Circuit 61 connector sleeve	4A
K52	Additional battery cut-off relay	5L
W4	Firewall ground point	5E
W5	Seat frame ground point	1H

PE15.00-D-2000-99T

[Display in a separate window](#)

To display wiring diagrams, you need a
JAVA 1.1 capable Browser like e.g. "Microsoft Internet Explorer 4.0"
or
"Netscape Navigator 4.05" and higher with AWT 1.1 support

F66	Additional battery isolating relay fuse (15 A)
F140	Fuse box
F140.1	Circuit 30 fuse (200 A)
G2	Battery
G9	Additional battery
G15	Generator 115A
J19	Circuit 61 connector sleeve
K53	Additional heavy-duty battery isolating relay
P15	Instrument cluster
W4	Ground point firewall
W5	Ground point seat frame
X195	Frame/engine connector
X209	Engine/Generator connector

PE15.00-D-2000-60T	Legend of wiring diagram starter, alternator	ENGINE 612.981 in MODEL YD1##, YD2##, YD3##, YD4##, YD5##, WD1##, WD2##, WD3## ### up to 313476 up to 31.8.01 ENGINE 612.981 in MODEL 903.66# /67#, 904.66# ## up to 313476 up to 31.8.01 with CODE (E28) Additional battery 12V/88 AH with CODE (E36) Cutoff relay with CODE (M35) Alternator 14 V / 115 A with CODE (ZU8) National version USA	
--------------------	--	---	--

Code	Designation	Coordinate
F66	Additional battery isolating relay fuse (15 A)	2H
F140	Fuse box	5E
F140.1	Circuit 30 fuse (200 A)	5E
G2	Battery	4A
G9	Additional battery	1A
G15	115 A generator	6A
J19	Circuit 61 connector sleeve	3A
K53	Additional heavy-duty battery isolating relay	2L
P15	Instrument cluster	7L
W4	Firewall ground point	3E
W5	Seat frame ground point	2E
X195	Frame/engine connector	6H
X209	Engine/alternator connector	6E

PE15.00-D-2000-99U

[Display in a separate window](#)

To display wiring diagrams, you need a
JAVA 1.1 capable Browser like e.g. "Microsoft Internet Explorer 4.0"
or
"Netscape Navigator 4.05" and higher with AWT 1.1 support

F66	Additional battery isolating relay fuse (15 A)
F140	Fuse box
F140.1	Circuit 30 fuse (200 A)
G2	Battery
G9	Additional battery
G15	Generator 115A
J19	Circuit 61 connector sleeve
K52	Additional battery cut-off relay
P15	Instrument cluster
W4	Ground point firewall
W5	Ground point seat frame
X195	Frame/engine connector
X209	Engine/Generator connector

PE15.00-D-2000-60U	Legend of wiring diagram starter, alternator	<p>ENGINE 612.981 in MODEL XD1, XD2, XD3, XD4, XD5, XD6, XD7, YD1##, YD2##, YD3##, YD4##, YD5##, YD6##, YD7##, WD1##, WD2##, WD3##, WD6##, WD7## ### as of 313477 as of 3.9.01</p> <p>ENGINE 612.981 in MODEL 903.61 /66 /67, 904.61 /66 with CODE (E28) Additional battery 12V/88 AH with CODE (E36) Cutoff relay with CODE (ZU7) National version Canada</p> <p>ENGINE 612.981 in MODEL 903.61# /66/67#, 904.61# /66# ## as of 313477 as of 3.9.01 with CODE (E28) Additional battery 12V/88 AH with CODE (E36) Cutoff relay with CODE (ZU8) National version USA</p> <p>ENGINE 612.981 in MODEL 903.61 /62 /66 67, 904.61 /62 /66 with CODE (E28) Additional battery 12V/88 AH with CODE (E36) Cutoff relay with CODE (ZU9) National version Canada</p>	
--------------------	--	--	--

Code	Designation	Coordinate
F66	Additional battery isolating relay fuse (15 A)	3H
F140	Fuse box	6E
F140.1	Circuit 30 fuse (200 A)	6E
G2	Battery	5A
G9	Additional battery	2A
G15	115 A generator	7A
J19	Circuit 61 connector sleeve	3A
K52	Additional battery cut-off relay	3L
P15	Instrument cluster	8L
W4	Firewall ground point	4E

W5	Seat frame ground point	2E
X195	Frame/engine connector	8H
X209	Engine/alternator connector	8E

PE15.00-D-2000-99W

[Display in a separate window](#)

To display wiring diagrams, you need a
JAVA 1.1 capable Browser like e.g. "Microsoft Internet Explorer 4.0"
or
"Netscape Navigator 4.05" and higher with AWT 1.1 support

A12	Electrical center
A94	CDI control module
A94	CDI control module
B16	Coolant temperature sensor
D4	Glow time output stage
D4	Glow time output stage
F70	D+ relay fuse (15 A)
F140	Fuse box
F140.1	Circuit 30 fuse (200 A)
F140.2	Circuit 30 fuse (70 A)
F140.3	Circuit 30 fuse (125 A)
F140.4	Circuit 30 fuse (80 A)
F140.5	Circuit 30 fuse (125 A)
F140.6	Circuit 30 fuse (100 A)
G1	Alternator
G2	Battery
J16	Circuit 30 connector sleeve
J18	Circuit 15, fused, connector sleeve
J19	Circuit 61 connector sleeve
J22	Circuit 15, fused, connector sleeve
J31	Terminal 15 connector sleeve, fused
J89	Circuit 56b connector sleeve
J312	Circuit 30 connector sleeve
J351	Circuit 15

	connector sleeve
J352	Circuit 50 connector sleeve
J421	CAN-low connector sleeve
J422	CAN-high connector sleeve
K26	Circuit D+ relay
K61	Starter relay
K70	Circuit 15 relay, for SA
M1	Starter
P15	Instrument cluster
P15	Instrument cluster
R13	Glow plug
R14	Glow plug
R15	Glow plug
R16	Glow plug
R17	Glow plug
S53	Steering lock with mechanical repeat start lockout
W4	Ground point firewall
W5	Ground point seat frame
W5	Ground point seat frame
W5	Ground point seat frame
W7	Ground point (engine compartment)
X237	Air mass meter connector

1

PE15.00-D-2000-60W	Legend of wiring diagram starter, alternator	<p>ENGINE 647.981 in MODEL XD1, XD2, XD3, XD4, XD5, XD6, XD7, YD1, YD2, YD3, YD4, YD5, YD6, YD7, WD1, WD2, WD3, WD6, WD7</p> <p>ENGINE 647.981 in MODEL 903.61 /66 /67, 904.61 /66 with CODE (ZU7) National version Canada</p> <p>ENGINE 647.981 in MODEL 903.61 /66 /67, 904.61 /66 with CODE (ZU8) National version USA</p> <p>ENGINE 647.981 in MODEL 903.61 /62 /66 /67, 904.61 /62 /66 with CODE (ZU9) National version Mexico</p>	
--------------------	--	---	--

Code	Designation	Coordinate
A12	Electrical center	21A
A94	CDI control unit	23L 27L
B16	Coolant temperature sensor	28A
D4	Glow time output stage	4A 9A
F70	D+ relay fuse (15 A)	6H
F140	Fuse box	10J
F140.1	Circuit 30 fuse (200 A)	12G
F140.2	Circuit 30 fuse (70 A)	11G
F140.3	Circuit 30 fuse (125 A)	10G
F140.4	Circuit 30 fuse (80 A)	13G
F140.5	Circuit 30 fuse (125 A)	11G
F140.6	Circuit 30 fuse (100 A)	12G
G1	Generator	17L
G2	Battery	10L
J16	Circuit 30 connector sleeve	8H
J18	Circuit 15 fused connector sleeve	19E
J19	Circuit 61 connector sleeve	7H
J22	Circuit 15 fused connector sleeve	12E

J31	Circuit 15 fused connector sleeve	13E
J89	Circuit 56b connector sleeve	5H
J312	Circuit 30 connector sleeve	20E
J351	Circuit 15 connector sleeve	20G
J352	Circuit 50 connector sleeve	21E
J421	CAN-low connector sleeve	24G
J422	CAN-high connector sleeve	25G
K26	Circuit D+ relay	6L
K61	Starter relay	21L
K70	Circuit 15 relay for optional equipment	12A
M1	Starter	15L
P15	Instrument cluster	3L 18A
R13	Glow plug	1E
R14	Glow plug	1E
R15	Glow plug	2E
R16	Glow plug	2E
R17	Glow plug	2E
S53	Steering lock with mechanical repeat start lockout	26A
W4	Firewall ground point	9H
W5	Seat frame ground point	4H 7H 12E
W7	Engine compartment ground point	4H
X237	Frame/engine connector	17H

PE82.00-D-2500-99C

[Display in a separate window](#)

To display wiring diagrams, you need a
JAVA 1.1 capable Browser like e.g. "Microsoft Internet Explorer 4.0"
or
"Netscape Navigator 4.05" and higher with AWT 1.1 support

F115	Circuit D+ body manufacturer fuse (10 A)
F116	Circuit 30 body manufacturer fuse (25 A)
F117	Circuit 15 body manufacturer fuse (15 A)
F140.3	Circuit 30 fuse (125 A)
F154	Instrument panel socket fuse (15 A)
G2	Battery
J16	Circuit 30 connector sleeve
J18	Circuit 15, fused, connector sleeve
J19	Circuit 61 connector sleeve
J327	Circuit 30 unfused connector sleeve
K78	Circuit D+ body manufacturer relay
K79	Circuit 15 body manufacturer relay
W4	Ground point firewall
W5	Ground point seat frame
W5	Ground point seat frame
W8	Ground point waistrail
X142	Frame/waistrail plug connection
X190	Body manufacturer plug connection
X233	Instrument panel socket

1

PE82.00-D-2500-60C	Legend for electric wiring diagram of sockets in interior	<p>Model XD1, XD2, XD3, XD4, XD5, XD6, XD7, YD1, YD2, YD3, YD4, YD5, YD6, YD7, WD1, WD2, WD3, WD6, WD7</p> <p>Models 903.61 /66 /67, 904.61 /66 with CODE (EK1) Terminal strip for electrical connection to driver seat frame with CODE (ES5) 12V socket in instrument panel with CODE (ZU7) Canada national version</p> <p>Models 903.61 /66 /67, 904.61 /66 with CODE (EK1) Terminal strip for electrical connection to driver seat frame with CODE (ES5) 12V socket in instrument panel with CODE (ZU8) USA national version</p> <p>Models 903.61 /62 /66 67, 904.61 62 /66 with CODE (EK1) Terminal strip for electrical connection to driver seat frame with CODE (ES5) 12V socket in instrument panel with CODE (ZU9) Mexico national version</p>	
--------------------	---	---	--

Code	Designation	Coordinate
F115	Circuit D+ body manufacturer fuse (10 A)	1G
F116	Circuit 30 body manufacturer fuse (25 A)	4G
F117	Circuit 15 body manufacturer fuse (15 A)	8G
F140.3	Circuit 30 fuse (125 A)	3E
F154	Instrument panel socket fuse (15 A)	9E
G2	Battery	3A
J16	Circuit 30 connector sleeve	5A
J18	Circuit 15 fused connector sleeve	6G
J19	Circuit 61 connector sleeve	2G
J327	Circuit 30 unfused connector sleeve	4E

K78	Circuit D+ body manufacturer relay	2L
K79	Circuit 15 body manufacturer relay	7L
W4	Firewall ground point	1A
W5	Seat frame ground point	2H 7H
W8	Ground point waistrail	10H
X142	Frame/waistrail connector	9H
X190	Body manufacturer connector	5L
X233	Instrument panel socket	10L

<p>GF00.19-D-3100-35C</p>	<p>Arrangement and assignment of terminal block connectors interior sockets</p>	<p>Models XD1, XD2, XD3, XD4, XD5, XD6, XD7, YD1, YD2, YD3, YD4, YD5, YD6, YD7, WD1, WD2, WD3, WD6, WD7 Models 903.61/66/67, 904.61/66 with code (EK1) Terminal strip for electrical connection at driver seat frame with code (ES5) Power outlet 12 V in instrument panel with code (ZU7) National version for Canada Models 903.61/66/67, 904.61/66 with code (EK1) Terminal strip for electrical connection at driver seat frame with code (ES5) Power outlet 12 V in instrument panel with code (ZU8) National version for USA Models 903.61/62/66/67, 904.61/62/66 with code (EK1) Terminal strip for electrical connection at driver seat frame with code (ES5) Power outlet 12 V in instrument panel with code (ZU9) National version for Mexico</p>	
---------------------------	---	---	--

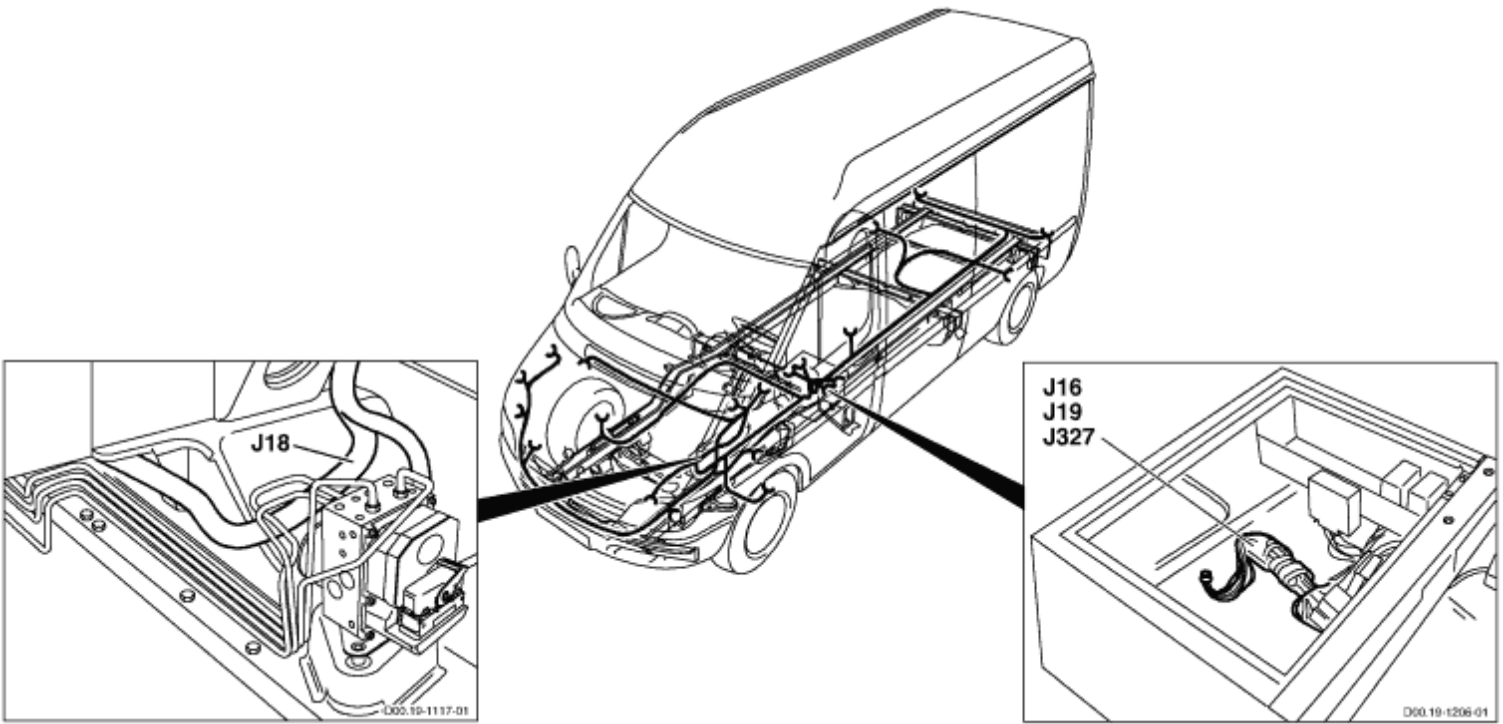

D00.19-1217-09

Terminal block	Designation		Component	Designation	Connector Pin
J16	FWH/seat frame (behind rubber grommet)	→	F6	ABS circuit 30 fuse	1
	Circuit 30 connector sleeve	→	F7	ABS circuit 30 fuse	1
		→	F9	Additional heater fuse (25 A)	1
		→	F11	Instrument cluster fuse (7.5 A)	1
		→	F40	Daytime running lamps fuse	1
		→	F43	Radio remote control fuse (10 A)	1
		→	F44	Central locking fuse (25 A)	1
		→	F62	Interior light fuse (15 A)	1
		→	F63	Heated rear window fuse (30 A)	1
		→	F98	Warm water heater stage 1 blower fuse (10 A)	1
		→	F101	Warm air additional heater fuse (7.5 A)	1
		→	F114	Additional heat exchanger fuse (25 A)	1
		→	F119	Air conditioning additional fan fuse (30 A)	1

		→	F138	Circuit 15 fuse (10 A)	1
		→	F140.3	Circuit 30 fuse (125 A)	2
		→	F143	Additional heater fuse (25 A)	1
		→	F148	Daytime running lamps relay fuse (10 A)	1
		→	F149	Roof AC fuse (40 A)	1
		→	F151	Fog lamp fuse (7.5 A)	1
		→	F153	Trailer socket fuse (25 A)	1
		→	F154	Instrument panel socket fuse (15 A)	1
		→	J327	Circuit 30 unfused connector sleeve	
		→	K26	Circuit D+ relay	1
J18	FWH/engine compartment (behind battery)	→	A10	Airbag control unit	1.5
	Circuit 15 fused connector sleeve	→	A12	Electrical center	4.3
		→	A80	CDI control unit	2.13
		→	K79	Circuit 15 body manufacturer relay	4
		→	P15	Instrument cluster	2.10
J19	FWH/seat frame (behind rubber grommet)	→	A8	Central locking control module	1.8
	Circuit 61 connector sleeve	→	F66	Additional battery isolating relay fuse (15 A)	1
		→	F70	D+ relay fuse (15 A)	2
		→	K3	Heated rear window relay	4
		→	K78	Circuit D+ body manufacturer relay	4
		→	K135	Daytime running lamps terminal 58L relay	2
		→	K136	Daytime running lamps terminal 58R relay	2
		→	K140	Daytime running lamps circuit 58 relay	2
		→	X82	Frame/waistrail connector	13
J327	FWH/seat frame (behind rubber grommet)	→	F115	Circuit D+ body manufacturer fuse (10 A)	1
	Circuit 30 unfused connector sleeve	→	F116	Circuit 30 body manufacturer fuse (25 A)	1
		→	F117	Circuit 15 body manufacturer fuse (15 A)	1

		→	J16	Circuit 30 connector sleeve	
--	--	---	-----	-----------------------------	--

PE82.10-D-2100-99F

[Display in a separate window](#)

To display wiring diagrams, you need a
JAVA 1.1 capable Browser like e.g. "Microsoft Internet Explorer 4.0"
or
"Netscape Navigator 4.05" and higher with AWT 1.1 support

A12	Electrical center
E25	Left headlight
E25e64	Left low beam
E26	Right headlight
E26e63	Right low beam
F148	Daytime running lamps relay fuse (10 A)
F40	Daytime running lamps fuse
F41	Daytime running lamps fuse
F68	Daytime running lamps fuse
F70	D+ relay fuse (15 A)
J148	Circuit 56b connector sleeve
J148	Circuit 56b connector sleeve
J148	Circuit 56b connector sleeve
J16	Circuit 30 connector sleeve
J19	Circuit 61 connector sleeve
J19	Circuit 61 connector sleeve
J19	Circuit 61 connector sleeve
J33	Circuit 58 connector sleeve
J341	Circuit 30, fused, connector sleeve
J341	Circuit 30, fused, connector sleeve
J4	Circuit 58R connector sleeve
J446	Circuit 58 connector sleeve
J46	Circuit 58 connector sleeve
J79	Circuit 58L connector sleeve
J89	Circuit 56b

	connector sleeve
J89	Circuit 56b connector sleeve
J89	Circuit 56b connector sleeve
K135	Daytime running lamps circuit 58L relay
K136	Daytime running lamps circuit 58R relay
K140	Daytime running lamps circuit 58 relay
K26	Circuit D+ relay
K68	daytime running lamps relay
K69	daytime running lamps relay
W5	Ground point seat frame
W5	Ground point seat frame
W5	Ground point seat frame
W5	Ground point seat frame
X79	Frame/waistrail plug connection

||

PE82.10-D-2100-60F	Electric circuit wiring diagram legend daytime dipped headlight	<p>Models XD1, XD2, XD3, XD4, XD5, XD6, XD7, YD1, YD2, YD3, YD4, YD5, YD6, YD7, WD1, WD2, WD3, WD6, WD7</p> <p>Models 903.61 /66 /67, 904.61 /66 with CODE (L05) Automatic daytime running lamps with CODE (ZU7) Canada national version</p> <p>Models 903.61 /66 /67, 904.61 /66 with CODE (L05) Automatic daytime running lamps with CODE (ZU8) USA national version</p>	
--------------------	---	--	--

Code	Designation	Coordinate
A12	Electrical center	13A
E25	Left headlamp	11A
E25	Left low beam	11B
E26	Right headlamp	15A
E26	Right low beam	15B
F40	Daytime running lamps fuse	3E
F41	Daytime running lamps fuse	10G
F68	Daytime running lamps fuse	14G
F70	D+ relay fuse (15 A)	1E
F148	Daytime running lamps relay fuse (10 A)	8G
J4	Circuit R connector sleeve 58R	18G
J16	Circuit 30 connector sleeve	4C
J19	Circuit 61 connector sleeve	2C 5G 16G
J33	Circuit 58 connector sleeve	8G
J46	Circuit 58 connector sleeve	8C
J79	Circuit 58L connector sleeve	5G
J89	Circuit 56b connector sleeve	1G 10E 14E

J148	Circuit 56b connector sleeve	10G 11G 15G
J341	Circuit 30 fused connector sleeve	3G 17G
J446	Circuit 58 connector sleeve	7G
K26	Circuit D+ relay	1L
K68	Daytime running lamps relay	11L
K69	Daytime running lamps relay	14L
K135	Daytime running lamps circuit 58L relay	3L
K136	Daytime running lamps circuit 58R relay	17L
K140	Daytime running lamps circuit 58 relay	7L
W5	Seat frame ground point	3G 6G 12G 16G
X79	Frame/waistrail connector	7E

GF00.19-D-3100-37D	Arrangement and assignment of terminal block connectors daytime running lamps	<p>Models XD1, XD2, XD3, XD4, XD5, XD6, XD7, YD1, YD2, YD3, YD4, YD5, YD6, YD7, WD1, WD2, WD3, WD6, WD7</p> <p>Models 903.61/66/67, 904.61/66</p> <p>with code (L05) Automatic daytime running lamps</p> <p>with code (ZU7) National version for Canada</p> <p>Models 903.61/66/67, 904.61/66</p> <p>with code (L05) Automatic daytime running lamps</p> <p>with code (ZU8) National version for USA</p>	
--------------------	---	--	--

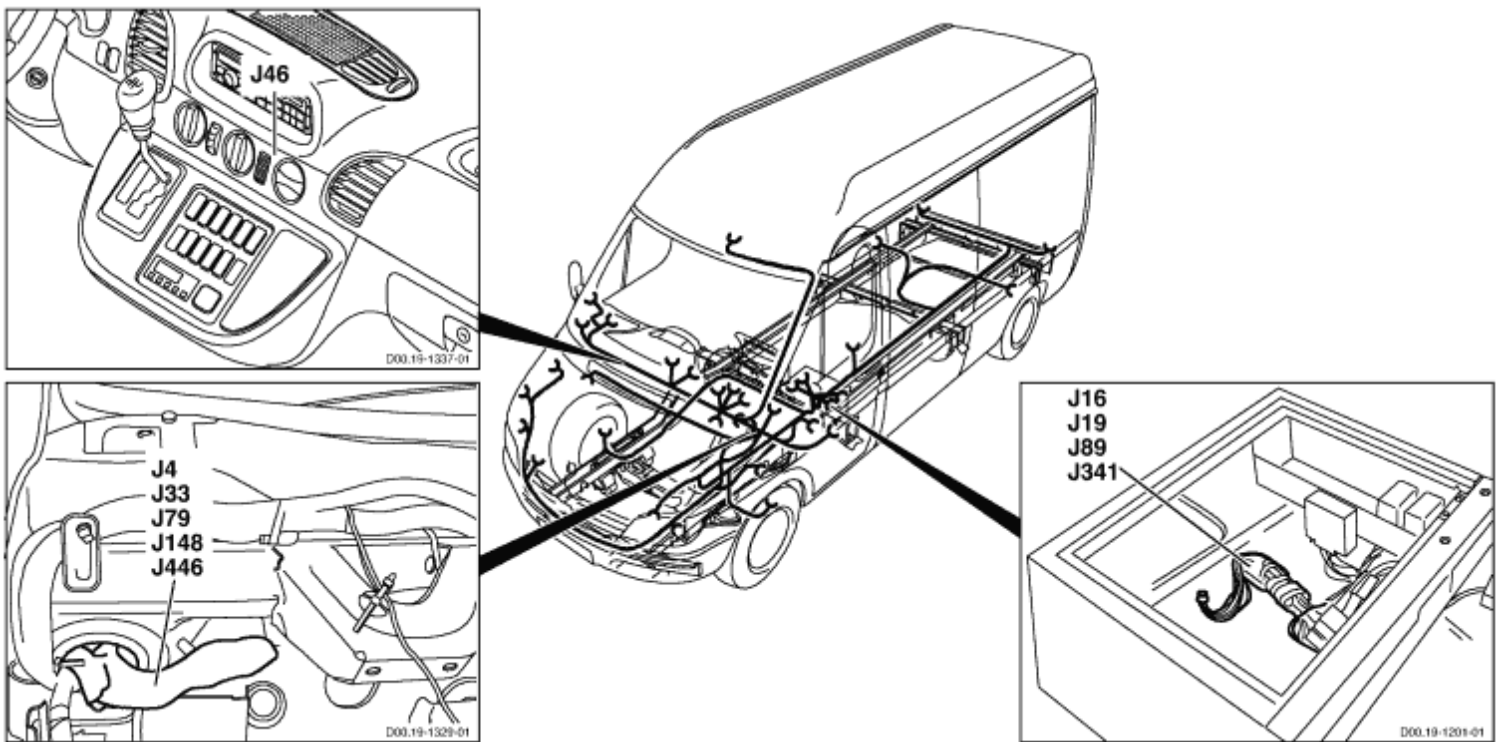

D00.19-1374-09

Terminal block	Designation		Component	Designation	Connector Pin
J4	FWH/waistrail (next to firewall rubber grommet)	→	A12	Electrical center	5.6
	Connector sleeve, terminal 58R	→	E26e6	Right side light	10
		→	E68E7	Right tail light	2

		→	K136	Daytime running lamps terminal 58R relay	1
J16	FWH/seat frame (behind rubber grommet)	→	F6	ABS circuit 30 fuse	1
	Circuit 30 connector sleeve	→	F7	ABS circuit 30 fuse	1
		→	F9	Additional heater fuse (25 A)	1
		→	F11	Instrument cluster fuse (7.5 A)	1
		→	F40	Daytime running lamps fuse	1
		→	F43	Radio remote control fuse (10 A)	1
		→	F44	Central locking fuse (25 A)	1
		→	F62	Interior light fuse (15 A)	1
		→	F63	Heated rear window fuse (30 A)	1
		→	F98	Warm water heater stage 1 blower fuse (10 A)	1
		→	F101	Warm air additional heater fuse (7.5 A)	1
		→	F114	Additional heat exchanger fuse (25 A)	1
		→	F119	Air conditioning additional fan fuse (30 A)	1
		→	F138	Circuit 15 fuse (10 A)	1
		→	F140.3	Circuit 30 fuse (125 A)	2
		→	F143	Additional heater fuse (25 A)	1
		→	F148	Daytime running lamps relay fuse (10 A)	1
		→	F149	Roof AC fuse (40 A)	1
		→	F151	Fog lamp fuse (7.5 A)	1
		→	F153	Trailer socket fuse (25 A)	1
		→	F154	Instrument panel socket fuse (15 A)	1
		→	J327	Circuit 30 unfused connector sleeve	
		→	K26	Circuit D+ relay	1
J19	FWH/seat frame (behind rubber grommet)	→	A8	Central locking control module	1.8
	Circuit 61 connector sleeve	→	F66	Additional battery isolating relay fuse (15 A)	1
		→	F70	D+ relay fuse (15 A)	2
		→	K3	Heated rear window relay	4

		→	K78	Circuit D+ body manufacturer relay	4
		→	K135	Daytime running lamps terminal 58L relay	2
		→	K136	Daytime running lamps terminal 58R relay	2
		→	K140	Daytime running lamps circuit 58 relay	2
		→	X82	Frame/waistrail connector	13
J33	FWH/waistrail (next to firewall rubber grommet)	→	A12	Electrical center	5.7
	Circuit 58 connector sleeve	→	J446	Circuit 58 connector sleeve	
		→	K140	Daytime running lamps circuit 58 relay	3
		→	X79	Frame/waistrail connector	2
J46	WWH (middle of instrument panel)	→	A9	Radio	1.A6
	Circuit 58 connector sleeve	→	A40	EWM control unit	2
		→	A71	Heater timer	1
		→	A81	Air conditioning pushbutton control and operating unit	1.9
		→	E104	Ashtray lighting	1
		→	S12	Driver seat heater switch	1
		→	S25	Headlamp range adjustment switch	9
		→	S48	ASR switch	1
		→	S57	Differential lock switch	1
		→	S81	Rear window defroster pushbutton	1
		→	S85	Driver interior lighting pushbutton	1
		→	S87	Auxiliary heater switch	1
		→	S90	Roof fan switch	1
		→	S92	Panic alarm button	1
		→	S99	ATA [EDW] towing/interior motion sensor button	1
		→	S100	Additional heat exchanger double-contact pushbutton	1
		→	S107	Front passenger seat heater switch	1
		→	S119.1	Fog light switch	1
		→	S124	Reading lamp switch	1

		→	S126	Interior pushbutton	1
		→	S137	Roof AC switch	1
		→	S138	Temperature switch	9
		→	X79	Frame/waistrail connector	2
		→	X234	Cigar lighter illumination plug connection	3
J79	FWH/waistrail (next to firewall rubber grommet)	→	A12	Electrical center	5.4
	Connector sleeve, terminal 58L	→	E25e9	Left side light	10
		→	E67e8	Left tail light	2
		→	K135	Daytime running lamps terminal 58L relay	1.1
J89	FWH/seat frame (behind rubber grommet)	→	F41	Daytime running lamps fuse	1
	Circuit 56b connector sleeve	→	F68	Daytime running lamps fuse	1
		→	F70	D+ relay fuse (15 A)	1
		→	K26	Circuit D+ relay	5
J148	FWH/waistrail (next to firewall rubber grommet)	→	A12	Electrical center	5.13
	Circuit 56b connector sleeve	→	E25e64	Left low beam	7
		→	K68	Daytime running lamps relay	1 2
		→	K69	Daytime running lamps relay	2
		→	X79	Frame/waistrail connector	13
J341	FWH/seat frame (behind rubber grommet)	→	F40	Daytime running lamps fuse	2
	Circuit 30 fused connector sleeve	→	K135	Daytime running lamps terminal 58L relay	5
		→	K136	Daytime running lamps terminal 58R relay	5
J446	FWH/waistrail (next to firewall rubber grommet)	→	E25	Left headlamp	1
	Circuit 58 connector sleeve	→	E26	Right headlamp	1
		→	J33	Circuit 58 connector sleeve	
		→	J144	Side marker light connector sleeve	
		→	J145	Side marker light connector sleeve	
		→	K140	Daytime running lamps circuit 58	3

				relay	5
		→	P15	Instrument cluster	2.7
		→	X26	Left rear license plate lighting contact plate 2-pin	1
		→	X45	Frame/roof connector (standard)	3 4

PE82.70-D-2000-99D

[Display in a separate window](#)

To display wiring diagrams, you need a
JAVA 1.1 capable Browser like e.g. "Microsoft Internet Explorer 4.0"
or
"Netscape Navigator 4.05" and higher with AWT 1.1 support

A9	Car radio
B14	Driver double coil speaker
F49	GSM 900 MHz CTEL circuit 15 fuse (7.5 A)
F129	CTEL/group channel communication, circuit 30 fuse (10 A)
J16	Circuit 30 connector sleeve
J31	Terminal 15 connector sleeve, fused
J163	Circuit 15R connector sleeve
J419	Circuit 15, fused, connector sleeve
W8	Ground point (waistrail)
W21	Active antenna (radio/CTEL/group channel communication)
X20	Driver double coil speaker connector
X63	CTEL antenna connector
X67.1	GSM 900 MHz hands-free microphone connector
X81	Frame/waistrail connector
X214	Portable CTEL preinstallation connector, mute function
X214	Portable CTEL preinstallation connector, mute function

PE82.70-D-2000-60D	Legend of wiring diagram of telephone(TEL)	<p>MODEL XD1, XD2, XD3, XD4, XD5, XD6, XD7, YD1, YD2, YD3, YD4, YD5, YD6, YD7, WD1, WD2, WD3, WD6, WD7</p> <p>MODEL 903.61 /66 /67, 904.61 /66</p> <p>with code (JV4) Portable CTEL telephone preinstallation with code (EV7)</p> <p>Preinstallation for hands-free system with code (ZU7) National version for Canada</p> <p>MODEL 903.61 /66 /67, 904.61 /66</p> <p>with code (JV4) Portable CTEL telephone preinstallation with code (EV7)</p> <p>Preinstallation for hands-free system with code (ZU8) National version for USA</p>	
--------------------	--	---	--

Code	Designation	Coordinate
A9	Radio	4L
B14	Driver dual coil speaker	6L
F49	Telephone 900 MHz circuit 15 fuse (7.5 A)	7K
F129	Telephone/group channel communication, circuit 30 fuse (10 A)	8K
J16	Circuit 30 connector sleeve	9G
J31	Circuit 15 fused connector sleeve	7G
J163	Circuit R connector sleeve 15R	2E
J419	Circuit 15 fused connector sleeve	7E
W8	Wastrail ground point	9E
W21	Active antenna (radio/Telephone/group channel communication)	3A
X20	Driver dual coil speaker connector	5E
X63	Telephone antenna connector	2L
X67.1	900 MHz GSM hands-free microphone connector	11L
X81	Frame/wastrail connector	7H
X214	Portable CTEL preinstallation, mute function connector	5A

GF00.19-D-3100-43C	Arrangement and assignment of terminal block connectors cellular telephone (CTEL)	<p>Models XD1, XD2, XD3, XD4, XD5, XD6, XD7, YD1, YD2, YD3, YD4, YD5, YD6, YD7, WD1, WD2, WD3, WD6, WD7</p> <p>Models 903.61/66/67, 904.61/66 with code (JV4) Portable CTEL telephone preinstallation with code (ZU7) National version for Canada</p> <p>Models 903.61/66/67, 904.61/66 with code (JV4) Portable CTEL telephone preinstallation with code (ZU8) National version for USA</p>	
--------------------	---	--	--

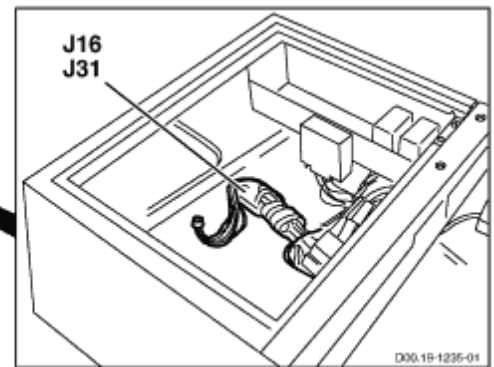
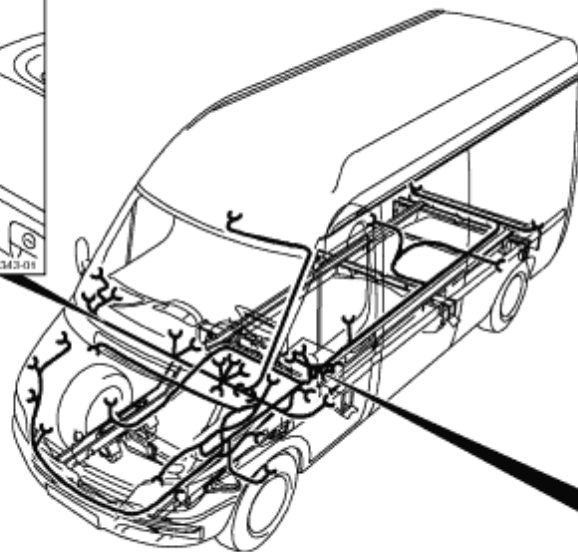
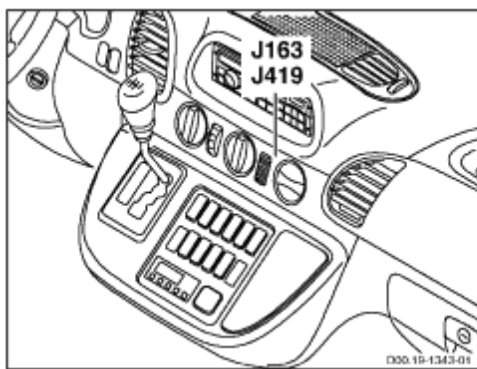

D00.19-1382-09

Terminal block	Designation		Component	Designation	Connector Pin
J16	FWH/seat frame (behind rubber grommet)	→	F6	ABS circuit 30 fuse	1
	Circuit 30 connector sleeve	→	F7	ABS circuit 30 fuse	1

		→	F9	Additional heater fuse (25 A)	1
		→	F11	Instrument cluster fuse (7.5 A)	1
		→	F40	Daytime running lamps fuse	1
		→	F43	Radio remote control fuse (10 A)	1
		→	F44	Central locking fuse (25 A)	1
		→	F62	Interior light fuse (15 A)	1
		→	F63	Heated rear window fuse (30 A)	1
		→	F98	Warm water heater stage 1 blower fuse (10 A)	1
		→	F101	Warm air additional heater fuse (7.5 A)	1
		→	F114	Additional heat exchanger fuse (25 A)	1
		→	F119	Air conditioning additional fan fuse (30 A)	1
		→	F138	Circuit 15 fuse (10 A)	1
		→	F140.3	Circuit 30 fuse (125 A)	2
		→	F143	Additional heater fuse (25 A)	1
		→	F148	Daytime running lamps relay fuse (10 A)	1
		→	F149	Roof AC fuse (40 A)	1
		→	F151	Fog lamp fuse (7.5 A)	1
		→	F153	Trailer socket fuse (25 A)	1
		→	F154	Instrument panel socket fuse (15 A)	1
		→	J327	Circuit 30 unfused connector sleeve	
		→	K26	Circuit D+ relay	1
J31	FWH/seat frame (behind rubber grommet)	→	F5	ABS terminal 15 fuse	1
	Circuit 15 fused connector sleeve	→	F52	Front passenger door power window fuse (25 A)	1
		→	F53	Driver door power window fuse (25 A)	1
		→	F54	Heated and adjustable exterior mirror fuse (10 A)	1
		→	F86	EDW circuit 15 fuse (7.5 A)	1
		→	F127	Differential lock fuse (15 A)	1

		→	F128	Driver, passenger seat heater fuse (15 A)	1
		→	F139	Additional heater fuse (10 A)	1
		→	F150	Roof fan fuse (15 A)	1
		→	K70	Circuit 15 relay for optional equipment	1
J163	WWH (middle of instrument panel)	→	A9	Radio	1.A7
	Connector sleeve, terminal 15R	→	W21	Active antenna (radio/telephone)	1
		→	X79	Frame/waistrail connector	7
J419	WWH (middle of instrument panel)	→	X81	Frame/waistrail connector	21
	Circuit 15 fused connector sleeve	→	X214	Portable CTEL connector	10 12

PE80.20-D-2000-99F

[Display in a separate window](#)

To display wiring diagrams, you need a
JAVA 1.1 capable Browser like e.g. "Microsoft Internet Explorer 4.0"
or
"Netscape Navigator 4.05" and higher with AWT 1.1 support

A8	Central locking control module
A8	Central locking control module
A8	Central locking control module
A8	Central locking control module
A8	Central locking control module
A10	Airbag control module
A12	Electrical center
A62	WSP control module
A82	ATA 2 control module
F44	Central locking fuse (25 A)
J16	Circuit 30 connector sleeve
J19	Circuit 61 connector sleeve
J46	Terminal 58 connector sleeve
J47	Central locking positioning motors connector sleeve
J48	Central locking positioning motors connector sleeve
J366	Central locking positioning motors connector sleeve
J366	Central locking positioning motors connector sleeve
J366	Central locking positioning motors connector sleeve
J366	Central locking positioning motors connector sleeve
J366	Central locking positioning motors connector sleeve
J367	Central locking positioning motors connector sleeve

J367	Central locking positioning motors connector sleeve
J367	Central locking positioning motors connector sleeve
J367	Central locking positioning motors connector sleeve
J371	Airbag crash signal connector sleeve
J375	Diagnostic line connector sleeve
J431	Circuit 15R fused connector sleeve
M22	Left central locking positioning motor
M22s1	Left central locking/convenience locking system positioning motor rotary tumbler switch
M22s2	Left central locking/convenience locking system positioning motor command switch
M23	Right central locking positioning motor
M23s1	Right central locking/convenience locking system positioning motor rotary tumbler switch
M23s2	Right central locking/convenience locking system positioning motor command switch
M24	Left sliding door central locking positioning motor
M24s1	Left sliding door central locking/convenience locking system

	positioning motor
	rotary tumbler
	switch
M24s2	Left sliding door central locking/convenience locking system positioning motor command switch
M25	Right sliding door central locking positioning motor
M25s1	Right sliding door central locking/convenience locking system positioning motor rotary tumbler switch
M25s2	Right sliding door central locking/convenience locking system positioning motor command switch
M26	Rear door central locking positioning motor
M26s1	Rear door central locking/convenience locking system positioning motor rotary tumbler switch
M26s2	Rear door central locking/convenience locking system positioning motor command switch
P17	Diagnostic socket, 16-pin
S126	Interior pushbutton
U1	Valid for central locking with rear window defroster
W5	Ground point seat frame
W8	Ground point

	(waistrail)
X27	Right side central locking contact plate
X27	Right side central locking contact plate
X28	Left side central locking contact plate
X28	Left side central locking contact plate
X30	Right rear central locking contact plate, 2-pin
X30	Right rear central locking contact plate, 2-pin
X34	Right rear contact plate, 3-pin
X34	Right rear contact plate, 3-pin
X46	Frame/roof connector (SA)
X53	Left front door central locking connector
X54	Left front door central locking connector, engine
X55	Right front door central locking connector
X56	Right front door central locking connector, engine
X80	Frame/waistrail connector
X80	Frame/waistrail connector
X194	ATA 2 connector

PE80.20-D-2000-60F	Legend for wiring diagram of central locking (CL)	<p>MODEL XD1, XD2, XD3, XD4, XD5, XD6, XD7, YD1, YD2, YD3, YD4, YD5, YD6, YD7, WD1, WD2, WD3, WD6, WD7</p> <p>MODEL 903.61 /66 /67, 904.61 /66 with CODE (FY6) Central locking with radio remote control</p> <p>with CODE (ZU7) National version for Canada</p> <p>MODEL 903.61 /66 /67, 904.61 /66 with CODE (FY6) Central locking with radio remote control</p> <p>with CODE (ZU8) National version for USA</p> <p>MODEL 903.61 /62 /66 /67, 904.61 /62 /66 with CODE (FY6) Central locking with radio remote control</p> <p>with CODE (ZU9) National version for Mexico</p>	
--------------------	---	--	--

Code	Designation	Coordinate
A8	Central locking control unit	4A 12A 20A 28A 36A
A10	Airbag control unit	35L
A12	Electrical center	32L
A62	WSP control unit	2L
A82	ATA control unit	4L
F44	Central locking fuse (25 A)	5E
J16	Circuit 30 connector sleeve	6G
J19	Circuit 61 connector sleeve	36E
J46	Circuit 58 connector sleeve	38G
J47	Central locking positioning motor connector sleeve	10E
J48	Central locking positioning motor connector sleeve	9E

J366	Central locking positioning motor connector sleeve	14D 16D 21D 26E
J367	Central locking positioning motor connector sleeve	15D 18D 22D 27E
J371	Airbag crash signal connector sleeve	35E
J375	Diagnostic cable connector sleeve	33E
J431	Circuit 15R fused connector sleeve	31E
M22	Left central locking positioning motor	8L
M22S1	Left central locking/convenience locking system positioning motor rotary tumbler switch	6K
M22S2	Left central locking/convenience locking system positioning motor command switch	8K
M23	Right central locking positioning motor	13L
M23S1	Right central locking/convenience locking system positioning motor rotary tumbler switch	11K
M23S2	Right central locking/convenience locking system positioning motor command switch	13K
M24	Left sliding door central locking positioning motor	18L
M24S1	Left sliding door central locking/convenience locking system positioning motor rotary tumbler switch	16K
M24S2	Left sliding door central locking/convenience locking system positioning motor command switch	20K
M25	Right sliding door central locking positioning motor	23L
M25S1	Right sliding door central locking/convenience locking system positioning motor rotary tumbler switch	21K
M25S2	Right sliding door central locking/convenience locking system positioning motor command switch	24K
M26	Rear door central locking positioning motor	28L
M26S1	Rear door central locking/convenience locking system positioning motor rotary tumbler switch	26K
M26S2	Rear door central locking/convenience locking system positioning motor command switch	29K
P17	Diagnostic socket, 16-pin	33H
S126	Interior compartment button	39L

U1	Valid for central locking with heated rear window	25A
W5	Seat frame ground point	7E
W8	Wastrail ground point	41H
X27	Right side central locking contact plate	20H 23H
X28	Left side central locking contact plate	16H 19H
X30	Right rear central locking contact plate 2-pin	25H 28H
X34	Right rear contact plate 3-pin	25H 28H
X46	Frame/roof connector (optional)	16F
X53	Left front door central locking connector	8H
X54	Left front door central locking motor connector	9H
X55	Right front door central locking connector	12H
X56	Right front door central locking motor connector	14H
X80	Frame/wastrail connector	12E 37E
X194	ATA [ATA] connector	3H

GF00.19-D-3100-30C

Arrangement and assignment of terminal block connectors central locking (CL)

Models XD1, XD2, XD3, XD4, XD5, XD6, XD7, YD1, YD2, YD3, YD4, YD5, YD6, YD7, WD1, WD2, WD3, WD6, WD7
Models 903.61/66 /67, 904.61 /66
with code (FY6) Central locking with radio remote control
with code (ZU7) National version for Canada
Models 903.61/66 /67, 904.61/66
with code (FY6) Central locking with radio remote control
with code (ZU8) National version for USA
Models 903.61/62/66/67, 904.61/62/66
with code (FY6) Central locking with radio remote control
with code (ZU9) National version for Mexico

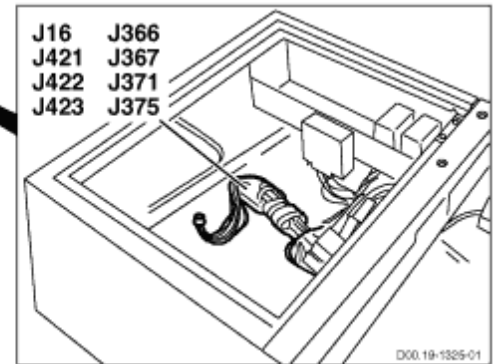
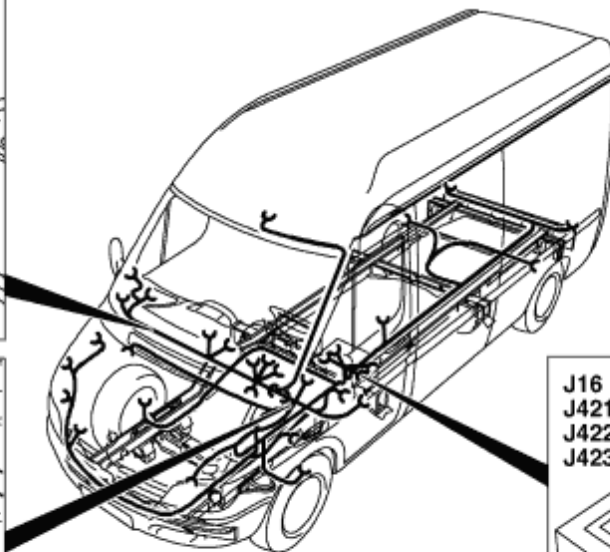
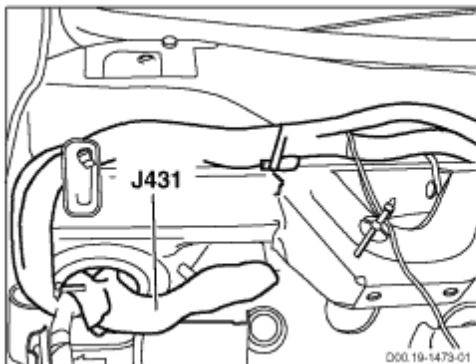
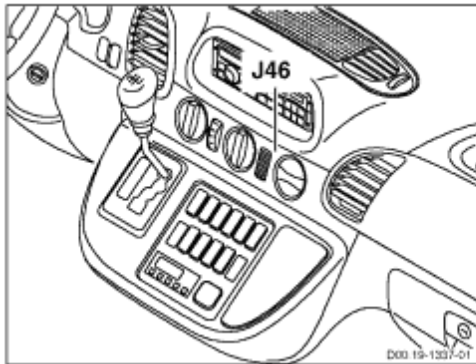

D00.19-1474-09

Terminal block	Designation		Component	Designation	Connector Pin
J16	FWH/seat frame (behind rubber grommet)	→	F6	ABS circuit 30 fuse	1
	Circuit 30 connector sleeve	→	F7	ABS circuit 30 fuse	1
		→	F9	Additional heater fuse (25 A)	1
		→	F11	Instrument cluster fuse (7.5 A)	1
		→	F40	Daytime running lamps fuse	1
		→	F43	Radio remote control fuse (10 A)	1
		→	F44	Central locking fuse (25 A)	1
		→	F62	Interior light fuse (15 A)	1
		→	F63	Heated rear window fuse (30 A)	1
		→	F98	Warm water heater stage 1 blower fuse (10 A)	1
		→	F101	Warm air additional heater fuse (7.5 A)	1
		→	F114	Additional heat exchanger fuse (25 A)	1
		→	F119	Air conditioning additional fan fuse (30 A)	1
		→	F138	Circuit 15 fuse (10 A)	1
		→	F140.3	Circuit 30 fuse (125 A)	2
		→	F143	Additional heater fuse (25 A)	1
		→	F148	Daytime running lamps relay fuse (10 A)	1
		→	F149	Roof AC fuse (40 A)	1
		→	F151	Fog lamp fuse (7.5 A)	1
		→	F153	Trailer socket fuse (25 A)	1
		→	F154	Instrument panel socket fuse (15 A)	1
		→	J327	Circuit 30 unfused connector sleeve	
		→	K26	Circuit D+ relay	1
J19	FWH/seat frame (behind rubber grommet)	→	A8	Central locking control module	1.8
	Circuit 61 connector sleeve	→	F66	Additional battery isolating relay fuse (15 A)	1

		→	F70	D+ relay fuse (15 A)	2
		→	K3	Heated rear window relay	4
		→	K78	Circuit D+ body manufacturer relay	4
		→	K135	Daytime running lamps terminal 58L relay	2
		→	K136	Daytime running lamps terminal 58R relay	2
		→	K140	Daytime running lamps circuit 58 relay	2
		→	X82	Frame/waistrail connector	13
J46	WWH (middle of instrument panel)	→	A9	Radio	1.A6
	Circuit 58 connector sleeve	→	A40	EWM control unit	2
		→	A71	Heater timer	1
		→	A81	Air conditioning pushbutton control and operating unit	1.9
		→	E104	Ashtray lighting	1
		→	S12	Driver seat heater switch	1
		→	S25	Headlamp range adjustment switch	9
		→	S48	ASR switch	1
		→	S57	Differential lock switch	1
		→	S81	Rear window defroster pushbutton	1
		→	S85	Driver interior lighting pushbutton	1
		→	S87	Auxiliary heater switch	1
		→	S90	Roof fan switch	1
		→	S92	Panic alarm button	1
		→	S99	ATA [EDW] towing/interior motion sensor button	1
		→	S100	Additional heat exchanger double-contact pushbutton	1
		→	S107	Front passenger seat heater switch	1
		→	S119.1	Fog light switch	1
		→	S124	Reading lamp switch	1
		→	S126	Interior pushbutton	1
		→	S137	Roof AC switch	1
		→	S138	Temperature switch	9
		→	X79	Frame/waistrail connector	2

		→	X234	Cigar lighter illumination plug connection	3
J47	FWH/seat frame (behind rubber grommet)	→	A8	Central locking control unit	1.2
	Central locking actuator motors connector sleeve	→	X54	Left front door central locking motor connector	2
J48	FWH/seat frame (behind rubber grommet)	→	A8	Central locking control unit	1.3
	Central locking positioning motor connector sleeve	→	X54	Left front door central locking motor connector	1
J366	FWH/seat frame (behind rubber grommet)	→	A8	Central locking control unit	2.17
	Central locking positioning motor connector sleeve	→	X30	Right rear central locking contact plate 2-pin	1
		→	X34	Right rear contact plate 3-pin	1
		→	X46	Frame/roof connector (optional)	5 9
		→	X80	Frame/roof connector (optional)	7
J367	FWH/seat frame (behind rubber grommet)	→	A8	Central locking control unit	2.18
	Central locking positioning motor connector sleeve	→	X30	Right rear central locking contact plate 2-pin	2
		→	X34	Right rear contact plate 3-pin	2
		→	X46	Frame/roof connector (optional)	6 10
		→	X80	Frame/roof connector (optional)	6
J371	FWH/seat frame (behind rubber grommet)	→	A8	Central locking control unit	1.11
	Airbag crash signal connector sleeve	→	A10	Airbag control unit	1.20
		→	A80	CDI control unit	2.17
J375	FWH/seat frame (behind rubber grommet)	→	A8	Central locking control unit	1.12
	Diagnostic cable connector sleeve	→	A82	EDW control unit	2.8
		→	P17	Diagnostic socket 16-pin	12
		→	X5.1	Additional heater connector LHS	3
J431	FWH/waistrail (next to firewall rubber grommet)	→	A8	Central locking control unit	1.10
	Circuit 15R, fused, connector sleeve	→	A12	Electrical center	4.9

		→	X79	Frame/engine connector	7
--	--	---	-----	------------------------	---

MODELS XD1, XD2, XD3, XD4, XD5, XD6, XD7, YD1, YD2, YD3, YD4, YD5, YD6, YD7, WD1, WD2, WD3, WD6, WD7

MODELS 903.61 /66 /67, 904.61 /66 with CODE (ZU7) National version for Canada

MODELS 903.61 /66 /67, 904.61 /66 with CODE (ZU8) National version for USA

MODELS 903.61 /62 /66 /67, 904.61 /62 /66 with CODE (ZU9) National version for Mexico

PE91.00-D-2000D	Wiring diagram of airbag (AB), emergency tensioning retractor (ETR)	<p>MODEL XD1, XD2, XD3, XD4, XD5, XD6, XD7, YD1, YD2, YD3, YD4, YD5, YD6, YD7, WD1, WD2, WD3, WD6, WD7</p> <p>MODELS 903.61 /66 /67, 904.61 /66</p> <p>with CODE (SA5) Driver airbag with CODE (SA6) Front passenger airbag with CODE (ZU7) National version for Canada</p> <p>MODELS 903.61 /66 /67, 904.61 /66</p> <p>with CODE (SA5) Driver airbag with CODE (SA6) Front passenger airbag with CODE (ZU8) National version for USA</p> <p>MODELS 903.61 /62 /66 /67, 904.61 /62 /66</p> <p>with CODE (SA5) Driver airbag with CODE (SA6) Front passenger airbag with CODE (ZU9) National version for Mexico</p>	PE91.00-D-2000D
PE91.30-D-2000D	Wiring diagram of heated seats (HS)	<p>MODEL XD1, XD2, XD3, XD4, XD5, XD6, XD7, YD1, YD2, YD3, YD4, YD5, YD6, YD7, WD1, WD2, WD3, WD6, WD7</p> <p>MODELS 903.61 /66 /67, 904.61 /66</p> <p>with CODE (H15) Heater for front passenger seat with CODE (H16) Heater for driver seat with CODE (ZU7) National</p>	PE91.30-D-2000D

	version Canada MODELS 903.61 /66/ 67, 904.61/66 with CODE (H15) Heater for front passenger seat with CODE (H16) Heater for driver seat with CODE (ZU8) National version USA	
--	---	--

PE83.70-D-2001-99LA[Display in a separate window](#)

To display wiring diagrams, you need a
JAVA 1.1 capable Browser like e.g. "Microsoft Internet Explorer 4.0"
or
"Netscape Navigator 4.05" and higher with AWT 1.1 support

A71	Heater timer
A82	ATA 2 control module
E18	Warm air auxiliary heater control module
E18b95	Overheating sensor
E18b96	Flame sensor
E18m44	Blower motor
E18r19	Glow pin
F9	Additional heater fuse (25 A)
F101	Warm air auxiliary heater fuse (7.5 A)
J16	Circuit 30 connector sleeve
J16	Circuit 30 connector sleeve
J46	Terminal 58 connector sleeve
J105	Terminal 15 connector sleeve
J302	Tml. 31 connector sleeve
J375	Diagnostic line connector sleeve
M16	Metering pump
P17	Diagnostic socket, 16-pin
W5	Ground point seat frame
W8	Ground point (wastrail)
X5.1	Auxiliary heater connector LHD
X5.2	Additional heater metering pump connector LHD
X80	Frame/wastrail connector
X82	Frame/wastrail connector

1

PE83.70-D-2001-60LA	Legend of wiring diagram of auxiliary heater (ACH)	<p>Models YD1##, YD2##, YD3##, YD4##, YD5##, YD6##, YD7##, WD1##, WD2##, WD3##, WD6##, WD7## ### from 382002 as of 12.3.02</p> <p>Models 903.66 /67, 904.66 with CODE (H11) Warm air auxiliary heater with CODE (ZU7) Canada national version</p> <p>Models 903.66# /67#, 904.66# ## from 382002 as of 12.3.02</p> <p>with CODE (H11) Warm air auxiliary heater with CODE (ZU8) USA national version</p> <p>Heater designation AIRTRONIC D4</p>	
---------------------	--	---	--

Code	Designation	Coordinate
A71	Heater timer	4L
A82	EDW control unit	9L
E18	Warm air auxiliary heater control unit	20L
E18b95	Overheating sensor	23B
E18b96	Flame sensor	22B
E18m44	Blower motor	24B
E18r19	Glow plug	20B
F9	Additional heater fuse (25 A)	12H
F101	Warm air additional heater fuse (7.5 A)	1E
J16	Circuit 30 connector sleeve	1A 12L
J46	Circuit 58 connector sleeve	6H
J105	Circuit 15 connector sleeve	2H
J302	Tml. 31 connector sleeve	3H
J375	Diagnostic cable connector sleeve	11G
M16	Metering pump	15L
P17	Diagnostic socket 16-pin	11L
W5	Seat frame ground point	13L

W8	Ground point waistrail	3E
X5.1	Additional heater connector LHS	4E
X5.2	Additional heater metering pump connector LHS	14E
X80	Frame/waistrail connector	4H
X82	Frame/waistrail connector	1H

GF00.19-D-3100-471	Arrangement and assignment of terminal block connectors auxiliary heater (ZHE)	Models YD1, YD2, YD3, YD4, YD5, YD6, YD7, WD1, WD2, WD3, WD6, WD7 Models 903.66/67, 904.66 with code (H11) Warm air auxiliary heater with code (ZU7) National version for Canada Models 903.66/67, 904.66 with code (H11) Warm air auxiliary heater with code (ZU8) National version for USA	
--------------------	--	--	--

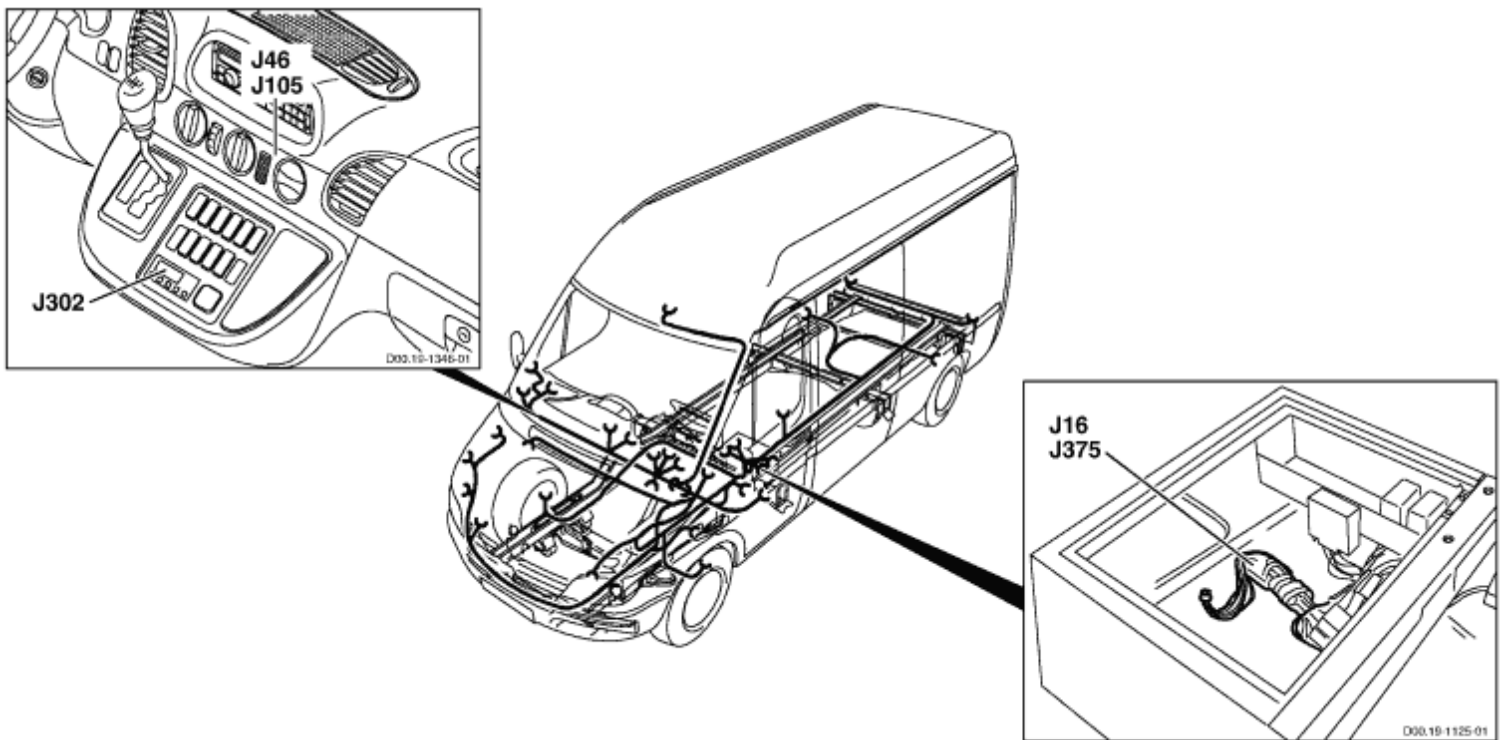

D00.19-1387-09

Terminal block	Designation		Component	Designation	Connector Pin
J16	FWH/seat frame (behind rubber grommet)	→	F6	ABS circuit 30 fuse	1
	Circuit 30 connector sleeve	→	F7	ABS circuit 30 fuse	1
		→	F9	Additional heater fuse (25 A)	1
		→	F11	Instrument cluster fuse (7.5 A)	1
		→	F40	Daytime running lamps fuse	1
		→			

			F43	Radio remote control fuse (10 A)	1
		→	F44	Central locking fuse (25 A)	1
		→	F62	Interior light fuse (15 A)	1
		→	F63	Heated rear window fuse (30 A)	1
		→	F98	Warm water heater stage 1 blower fuse (10 A)	1
		→	F101	Warm air additional heater fuse (7.5 A)	1
		→	F114	Additional heat exchanger fuse (25 A)	1
		→	F119	Air conditioning additional fan fuse (30 A)	1
		→	F138	Circuit 15 fuse (10 A)	1
		→	F140.3	Circuit 30 fuse (125 A)	2
		→	F143	Additional heater fuse (25 A)	1
		→	F148	Daytime running lamps relay fuse (10 A)	1
		→	F149	Roof AC fuse (40 A)	1
		→	F151	Fog lamp fuse (7.5 A)	1
		→	F153	Trailer socket fuse (25 A)	1
		→	F154	Instrument panel socket fuse (15 A)	1
		→	J327	Circuit 30 unfused connector sleeve	
		→	K26	Circuit D+ relay	1
J46	WWH (middle of instrument panel)	→	A9	Radio	1.A6
	Circuit 58 connector sleeve	→	A40	EWM control unit	2
		→	A71	Heater timer	1
		→	A81	Air conditioning pushbutton control and operating unit	1.9
		→	E104	Ashtray lighting	1
		→	S12	Driver seat heater switch	1
		→	S25	Headlamp range adjustment switch	9
		→	S48	ASR switch	1
		→	S57	Differential lock switch	1
		→	S81	Rear window defroster pushbutton	1
		→	S85	Driver interior lighting pushbutton	1
		→	S87	Auxiliary heater switch	1

		→	S90	Roof fan switch	1
		→	S92	Panic alarm button	1
		→	S99	ATA [EDW] towing/interior motion sensor button	1
		→	S100	Additional heat exchanger double-contact pushbutton	1
		→	S107	Front passenger seat heater switch	1
		→	S119.1	Fog light switch	1
		→	S124	Reading lamp switch	1
		→	S126	Interior pushbutton	1
		→	S137	Roof AC switch	1
		→	S138	Temperature switch	9
		→	X79	Frame/waistrail connector	2
		→	X234	Cigar lighter illumination plug connection	3
J105	WWH (middle of instrument panel)	→	A71	Heater timer	10
	Circuit 15 connector sleeve	→	A81	Air conditioning pushbutton control and operating unit	1.21
		→	S48	ASR switch	7
		→	S100	Additional heat exchanger double-contact pushbutton	3 8
		→	X79	Frame/waistrail connector	1
J302	WWH (close to heater timer A71)	→	A71	Heater timer	4 12
	Tml. 31 connector sleeve	→	W8	Ground point waistrail	
J375	FWH/seat frame (behind rubber grommet)	→	A8	Central locking control unit	1.12
	Diagnostic cable connector sleeve	→	A82	EDW control unit	2.8
		→	P17	Diagnostic socket 16-pin	12
		→	X5.1	Additional heater connector LHS	3

PE83.70-D-2001-99S[Display in a separate window](#)

To display wiring diagrams, you need a
JAVA 1.1 capable Browser like e.g. "Microsoft Internet Explorer 4.0"
or
"Netscape Navigator 4.05" and higher with AWT 1.1 support

A71	Heater timer
A82	ATA 2 control module
E18	Warm air auxiliary heater control module
E18	Warm air auxiliary heater control module
E18b95	Overheating sensor
E18b96	Flame sensor
E18m44	Blower motor
E18r18	Glow plug
F9	Additional heater fuse (25 A)
F101	Warm air auxiliary heater fuse (7.5 A)
J16	Circuit 30 connector sleeve
J16	Circuit 30 connector sleeve
J46	Terminal 58 connector sleeve
J105	Terminal 15 connector sleeve
J302	Tml. 31 connector sleeve
J375	Diagnostic line connector sleeve
M16	Metering pump
P17	Diagnostic socket, 16-pin
W5	Ground point seat frame
W8	Ground point (waistrail)
X5.1	Auxiliary heater connector LHD
X5.2	Additional heater metering pump connector LHD
X80	Frame/waistrail connector

X82

Frame/waistrail
connector

PE83.70-D-2001-60S	Legend of wiring diagram of auxiliary heater (ACH)	Models YD1##, YD2##, YD3##, YD4##, YD5##, WD1##, WD2##, WD3## ### to 382001 up to 11.3.02 Models 903.66# /67#, 904.66# ## to 382001 up to 11.3.02 with CODE (H11) Warm air auxiliary heater with CODE (ZU8) USA national version Heater designation D2L-C compact	
--------------------	--	---	--

Code	Designation	Coordinate
A71	Heater timer	4L
A82	EDW control unit	9L
E18	Warm air auxiliary heater control unit	20L 25L
E18b95	Overheating sensor	22B
E18b96	Flame sensor	23B
E18m44	Blower motor	25B
E18r18	Glow plug	21B
F9	Additional heater fuse (25 A)	12H
F101	Warm air additional heater fuse (7.5 A)	1E
J16	Circuit 30 connector sleeve	1A 12L
J46	Circuit 58 connector sleeve	6H
J105	Circuit 15 connector sleeve	2H
J302	Tml. 31 connector sleeve	3H
J375	Diagnostic cable connector sleeve	11G
M16	Metering pump	15L
P17	Diagnostic socket 16-pin	11L
W5	Seat frame ground point	13L
W8	Ground point waistrail	3E
X5.1	Additional heater connector LHS	4E
X5.2	Additional heater metering pump connector LHS	14E
X80	Frame/waistrail connector	4H

PE83.70-D-2001-99T[Display in a separate window](#)

To display wiring diagrams, you need a
JAVA 1.1 capable Browser like e.g. "Microsoft Internet Explorer 4.0"
or
"Netscape Navigator 4.05" and higher with AWT 1.1 support

A81	Air conditioning pushbutton control module
E90	Warm water auxiliary heater control module
E90	Warm water auxiliary heater control module
E90b96	Flame sensor
E90b97	Temperature sensor
E90b98	Overheating sensor
E90m46	Blower motor
E90r18	Glow plug
F139	Auxiliary heater fuse (10 A)
F143	Additional heater fuse (25 A)
J16	Circuit 30 connector sleeve
J31	Circuit 15, fused, connector sleeve
J372	Diagnostic cable connector sleeve
J425	Circuit 15, fused, connector sleeve
M51	Circulation pump
M54	Metering pump
P17	Diagnostic socket, 16-pin
V15	Circulation pump diode
W4	Ground point firewall
W7	Ground point (engine compartment)
X165	Warm water auxiliary heater connector, 8-pin
X82	Frame/waistrail plug connection

1

PE83.70-D-2001-60T	Legend of wiring diagram of auxiliary heater (ACH)	<p>MODEL XD1, XD2, XD3, XD4, XD5, XD6, XD7, YD1, YD2, YD3, YD4, YD5, YD6, YD7, WD1, WD2, WD3, WD6, WD7</p> <p>MODELS 903.61 /66 /67, 904.61 /66 with CODE (HZ9) Heater booster, diesel with CODE (ZU7) National version Canada</p> <p>MODELS 903.61 /66 /67, 904.61 /66 with CODE (HZ9) Heater booster, diesel with CODE (ZU8) National version USA</p>	
--------------------	--	---	--

Code	Designation	Coordinate
A81	Air conditioning pushbutton control and operating unit	4A
E90	Warm water additional heater control unit	13L 20L
E90b96	Flame sensor	22B
E90b97	Temperature sensor	21B
E90b98	Overheating sensor	19B
E90m46	Blower motor	17B
E90r18	Glow plug	18B
F139	Additional heater fuse (10 A)	6E
F143	Additional heater fuse (25 A)	4E
J16	Circuit 30 connector sleeve	5A
J31	Circuit 15 fused connector sleeve	7A
J372	Diagnostic cable connector sleeve	5E
J425	Circuit 15 fused connector sleeve	8E
M51	Circulating pump	10A
M54	Metering pump	1A
P17	Diagnostic socket 16-pin	6A
V15	Circulation pump diode	8A
W4	Firewall ground point	10E
W7	Engine compartment ground point	3A

X82	Frame/waistrail connector	3E
X165	Warm water additional heater connector 8-pin	10J

GF00.19-D-3100-47K

Arrangement and assignment of terminal block connectors auxiliary heater (ZHE)

Models XD1, XD2, XD3, XD4, XD5, XD6, XD7, YD1, YD2, YD3, YD4, YD5, YD6, YD7, WD1, WD2, WD3, WD6, WD7
Models 903.61/66/67, 904.61/66
with code (HZ9) Heater booster, diesel
with code (H13) Additional heat exchanger in the load compartment
with code (ZU7) National version for Canada
Models 903.61/66/67, 904.61/66
with code (HZ9) Heater booster, diesel
with code (H13) Additional heat exchanger in the load compartment
with code (ZU8) National version for USA
Models 903.66/67, 904.66
with code (H13) Additional heat exchanger in the load compartment
with code (ZU9) National version for Mexico

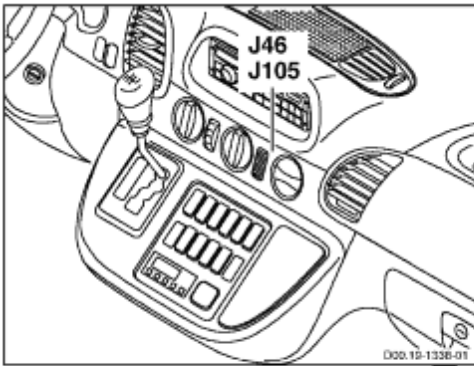

000.19-1330-01

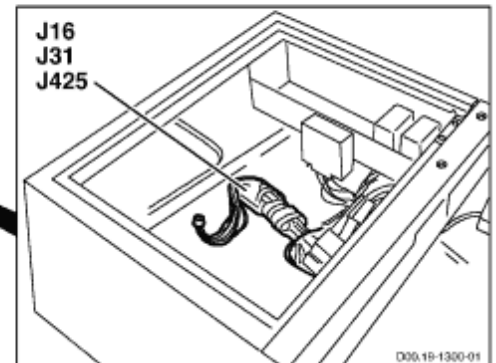
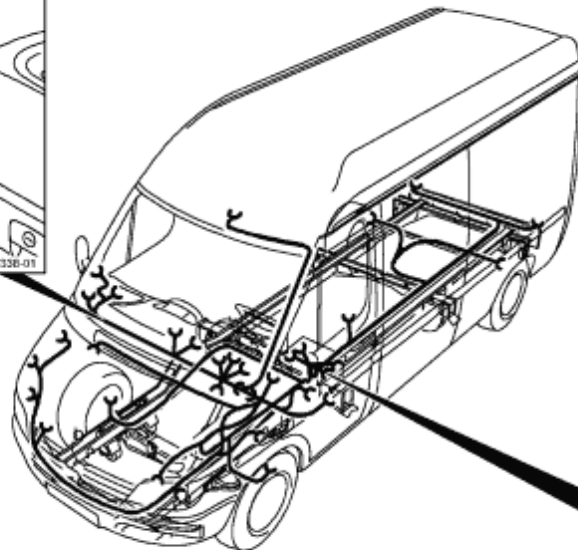

000.19-1300-01

Terminal block	Designation		Component	Designation	Connector Pin
J16	FWH/seat frame (behind rubber grommet)	→	F6	ABS circuit 30 fuse	1
	Circuit 30 connector sleeve	→	F7	ABS circuit 30 fuse	1
		→	F9	Additional heater fuse (25 A)	1
		→	F11	Instrument cluster fuse (7.5 A)	1
		→	F40	Daytime running lamps fuse	1
		→	F43	Radio remote control fuse (10 A)	1
		→	F44	Central locking fuse (25 A)	1
		→	F62	Interior light fuse (15 A)	1
		→	F63	Heated rear window fuse (30 A)	1
		→	F98	Warm water heater stage 1 blower fuse (10 A)	1
		→	F101	Warm air additional heater fuse (7.5 A)	1
		→	F114	Additional heat exchanger fuse (25 A)	1
		→	F119	Air conditioning additional fan fuse (30 A)	1
		→	F138	Circuit 15 fuse (10 A)	1
		→	F140.3	Circuit 30 fuse (125 A)	2
		→	F143	Additional heater fuse (25 A)	1
		→	F148	Daytime running lamps relay fuse (10 A)	1
		→	F149	Roof AC fuse (40 A)	1
		→	F151	Fog lamp fuse (7.5 A)	1
		→	F153	Trailer socket fuse (25 A)	1
		→	F154	Instrument panel socket fuse (15 A)	1
		→	J327	Circuit 30 unfused connector sleeve	
		→	K26	Circuit D+ relay	1
J31	FWH/seat frame (behind rubber grommet)	→	F5	ABS terminal 15 fuse	1
	Circuit 15 fused connector sleeve	→	F52	Front passenger door power window	1

				fuse (25 A)	
		→	F53	Driver door power window fuse (25 A)	1
		→	F54	Heated and adjustable exterior mirror fuse (10 A)	1
		→	F86	EDW circuit 15 fuse (7.5 A)	1
		→	F127	Differential lock fuse (15 A)	1
		→	F128	Driver, passenger seat heater fuse (15 A)	1
		→	F139	Additional heater fuse (10 A)	1
		→	F150	Roof fan fuse (15 A)	1
		→	K70	Circuit 15 relay for optional equipment	1
J46	WWH (middle of instrument panel)	→	A9	Radio	1.A6
	Circuit 58 connector sleeve	→	A40	EWM control unit	2
		→	A71	Heater timer	1
		→	A81	Air conditioning pushbutton control and operating unit	1.9
		→	E104	Ashtray lighting	1
		→	S12	Driver seat heater switch	1
		→	S25	Headlamp range adjustment switch	9
		→	S48	ASR switch	1
		→	S57	Differential lock switch	1
		→	S81	Rear window defroster pushbutton	1
		→	S85	Driver interior lighting pushbutton	1
		→	S87	Auxiliary heater switch	1
		→	S90	Roof fan switch	1
		→	S92	Panic alarm button	1
		→	S99	ATA [EDW] towing/interior motion sensor button	1
		→	S100	Additional heat exchanger double-contact pushbutton	1
		→	S107	Front passenger seat heater switch	1
		→	S119.1	Fog light switch	1
		→	S124	Reading lamp switch	1
		→	S126	Interior pushbutton	1

		→	S137	Roof AC switch	1
		→	S138	Temperature switch	9
		→	X79	Frame/waistrail connector	2
		→	X234	Cigar lighter illumination plug connection	3
J105	WWH (middle of instrument panel)	→	A71	Heater timer	10
	Circuit 15 connector sleeve	→	A81	Air conditioning pushbutton control and operating unit	1.21
		→	S48	ASR switch	7
		→	S100	Additional heat exchanger double-contact pushbutton	3 8
		→	X79	Frame/waistrail connector	1
J425	FWH/seat frame (behind rubber grommet)	→	F139	Additional heater fuse (10 A)	2
	Circuit 15 fused connector sleeve	→	K58	Additional heat exchanger relay	4
		→	V15	Circulation pump diode	4
		→	X165	Warm water auxiliary heater connector, 8-pin	6

PE83.70-D-2001-99U

[Display in a separate window](#)

To display wiring diagrams, you need a
JAVA 1.1 capable Browser like e.g. "Microsoft Internet Explorer 4.0"
or
"Netscape Navigator 4.05" and higher with AWT 1.1 support

- E90 Warm water auxiliary heater control module
- F114 Additional heat exchanger fuse (25 A)
- J105 Circuit 15 connector sleeve
- J16 Circuit 30 connector sleeve
- J425 Circuit 15, fused, connector sleeve
- J46 Circuit 58 connector sleeve
- K58 Additional heat exchanger relay
- S100 Additional heat exchanger two-way switch
- W5 Ground point seat frame
- W8 Ground point waistrail
- W8 Ground point waistrail
- X165 Warm water auxiliary heater connector, 8-pin
- X189 Additional heat exchanger connector
- X81 Frame/waistrail plug connection

PE83.70-D-2001-60U	Legend of wiring diagram of auxiliary heater (ACH)	<p>Models YD1, YD2, YD3, YD4, YD5, YD6, YD7, WD1, WD2, WD3, WD6, WD7</p> <p>Models 903.66 /67, 904.66 with CODE (H13) Additional heat exchanger in the load compartment with CODE (ZU7) National version for Canada</p> <p>Models 903.66 /67, 904.66 with CODE (H13) Additional heat exchanger in the load compartment with CODE (ZU8) National version for USA</p> <p>Models 903.66 /67, 904.66 with CODE (H13) Additional heat exchanger in the load compartment with CODE (ZU9) National version for Mexico</p>	
--------------------	--	--	--

Code	Designation	Coordinate
E90	Warm water additional heater control unit	7A
F114	Additional heat exchanger fuse (25 A)	5G
J16	Circuit 30 connector sleeve	6L
J46	Circuit 58 connector sleeve	5E
J105	Circuit 15 connector sleeve	2E
J425	Circuit 15 fused connector sleeve	4G
K58	Additional heat exchanger relay	4L
S100	Additional heat exchanger double-contact pushbutton	3A
W5	Seat frame ground point	2G
W8	Ground point waistrail	2E 5E
X81	Frame/waistrail connector	1H
X165	Warm water additional heater connector 8-pin	6E
X189	Additional heat exchanger connector	2L

PE83.70-D-2001-99V

[Display in a separate window](#)

To display wiring diagrams, you need a
JAVA 1.1 capable Browser like e.g. "Microsoft Internet Explorer 4.0"
or
"Netscape Navigator 4.05" and higher with AWT 1.1 support

A12	Electrical center
A71	Heater timer
A81	Air conditioning pushbutton control module
E90	Auxiliary warm water heater control module
E90	Auxiliary warm water heater control module
E90b96	Flame sensor
E90b97	Temperature sensor
E90b98	Overheating sensor
E90m46	Blower motor
E90r18	Glow pin
F98	Warm water heater blower stage 1 fuse (10 A)
F101	Warm air auxiliary heater fuse (7.5 A)
F143	Additional heater fuse (25 A)
J16	Circuit 30 connector sleeve
J16	Circuit 30 connector sleeve
J22	Circuit 15, fused, connector sleeve
J46	Terminal 58 connector sleeve
J46	Terminal 58 connector sleeve
J58	Circuit 30 connector sleeve
J105	Terminal 15 connector sleeve
J302	Tml. 31 connector sleeve
J337	ATA 2 blower stage connector sleeve

J372	Diagnostic line connector sleeve
J377	Circuit 30 connector sleeve
K75	Fan stage 1 warm water heater relay
K103	Circulating pump relay
M51	Circulating pump
M54	Metering pump
P17	Diagnostic socket, 16-pin
S87	Auxiliary heating switch
V15	Circulation pump diode
W4	Ground point firewall
W5	Ground point seat frame
W5	Ground point seat frame
W7	Ground point (engine compartment)
W8	Ground point (wastrail)
W8	Ground point (wastrail)
X79	Frame/wastrail connector
X82	Frame/wastrail connector
X82	Frame/wastrail connector
X82	Frame/wastrail connector
X164	Warm water auxiliary heater connector, 2-pin
X165	Warm water auxiliary heater connector, 8-pin
X194	ATA 2 connector



PE83.70-D-2001-60V	Legend of wiring diagram of auxiliary heater (ACH)	<p>MODEL XD1, XD2, XD3, XD4, XD5, XD6, XD7, YD1, YD2, YD3, YD4, YD5, YD6, YD7, WD1, WD2, WD3, WD6, WD7</p> <p>MODELS 903.61 /66 /67, 904.61 /66 with CODE (H12) Warm water auxiliary heater with CODE (H86) Timer for auxiliary heater with CODE (ZU7) National version for Canada</p> <p>MODELS 903.61 /66 /67, 904.61 /66 with CODE (H12) Warm water auxiliary heater with CODE (H86) Timer for auxiliary heater with CODE (ZU8) National version for USA</p> <p>MODELS 903.61 /62 /66 /67, 904.61 /62 /66 with CODE (H12) Warm water auxiliary heater with CODE (H86) Timer for auxiliary heater with CODE (ZU9) National version for Mexico</p> <p>Heater unit designation D5WS</p>	
--------------------	--	---	--

Code	Designation	Coordinate
A12	Electrical center	30A
A71	Heater timer	4L
A81	Air conditioning pushbutton control and operating unit	24A
E90	Warm water additional heater control unit	37L 44L
E90b96	Flame sensor	47B
E90b97	Temperature sensor	46B
E90b98	Overheating sensor	44B
E90m46	Blower motor	41B
E90r18	Glow plug	43B
F98	Warm water heater stage 1 blower fuse (10 A)	20E

F101	Warm air additional heater fuse (7.5 A)	1E
F143	Additional heater fuse (25 A)	21E
J16	Circuit 30 connector sleeve	1A 22A
J22	Circuit 15 fused connector sleeve	27E
J46	Circuit 58 connector sleeve	6H 10E
J58	Circuit 30 connector sleeve	9E
J105	Circuit 15 connector sleeve	2H
J302	Tml. 31 connector sleeve	3H
J337	ATA [EDW] blower stage connector sleeve	18E
J372	Diagnostic cable connector sleeve	22E
J377	Circuit 30 connector sleeve	28E
K75	Fan stage 1 warm water heater relay	20A
K103	Circulation pump relay	27A
M51	Circulating pump	34A
M54	Metering pump	14A
P17	Diagnostic socket 16-pin	23A
S87	Auxiliary heater switch	10A
V15	Circulation pump diode	32A
W4	Firewall ground point	35A
W5	Seat frame ground point	19E 26E
W7	Engine compartment ground point	15A
W8	Ground point waistrail	3E 9E
X79	Frame/waistrail connector	9H
X82	Frame/waistrail connector	1H 16C 23E
X164	Warm water additional heater connector 2-pin	35F
X165	Warm water additional heater connector 8-pin	35J
X194	ATA [EDW] connector	16F

<p>GF00.19-D-3100-47J</p>	<p>Arrangement and assignment of terminal block connectors auxiliary heater (ZHE)</p>	<p>Models XD1, XD2, XD3, XD4, XD5, XD6, XD7, YD1, YD2, YD3, YD4, YD5, YD6, YD7, WD1, WD2, WD3, WD6, WD7</p> <p>Models 903.61/66/67, 904.61/66 with code (H12) Warm water auxiliary heater with code (H86) Timer for auxiliary heater with code (ZU7) National version for Canada</p> <p>Models 903.61/66/67, 904.61/66 with code (H12) Warm water auxiliary heater with code (H86) Timer for auxiliary heater with code (ZU8) National version for USA</p> <p>Models 903.61/62/66/67, 904.61/62/66 with code (H12) Warm water auxiliary heater with code (H86) Timer for auxiliary heater with code (ZU9) National version for Mexico</p>	
---------------------------	---	---	--

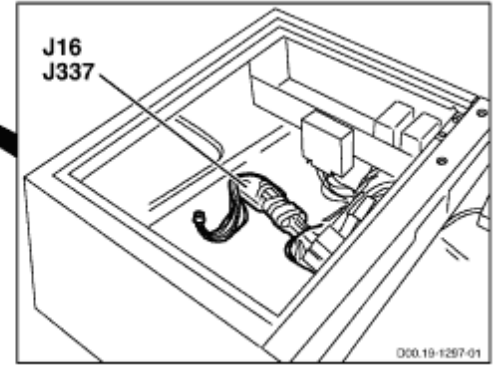
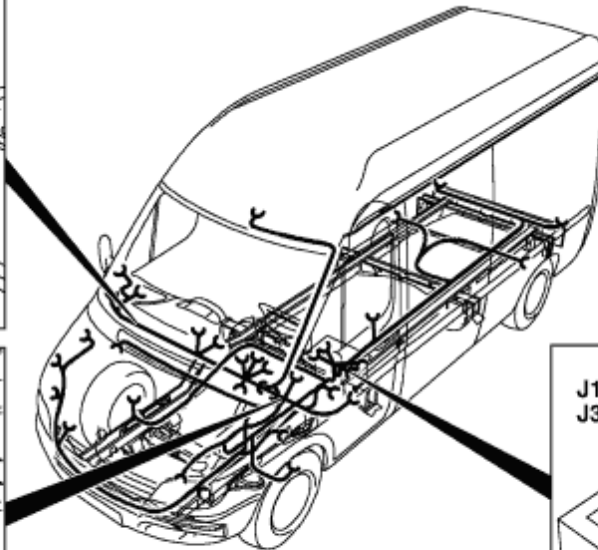
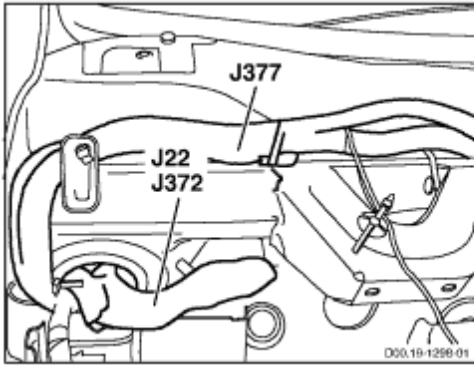
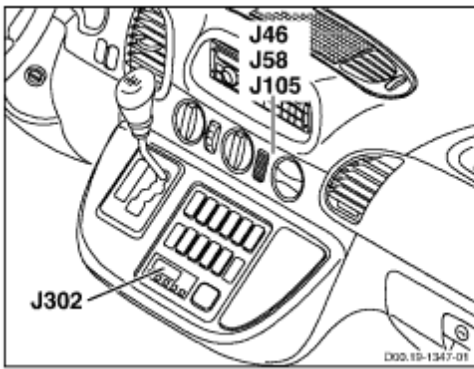

D00.19-1388-09

Terminal block	Designation		Component	Designation	Connector Pin
J16	FWH/seat frame (behind rubber grommet)	→	F6	ABS circuit 30 fuse	1
	Circuit 30 connector sleeve	→	F7	ABS circuit 30 fuse	1
		→	F9	Additional heater fuse (25 A)	1
		→	F11	Instrument cluster fuse (7.5 A)	1
		→	F40	Daytime running lamps fuse	1
		→	F43	Radio remote control fuse (10 A)	1
		→	F44	Central locking fuse (25 A)	1
		→	F62	Interior light fuse (15 A)	1
		→	F63	Heated rear window fuse (30 A)	1
		→	F98	Warm water heater stage 1 blower fuse (10 A)	1
		→	F101	Warm air additional heater fuse (7.5 A)	1
		→	F114	Additional heat exchanger fuse (25 A)	1
		→	F119	Air conditioning additional fan fuse (30 A)	1

		→	F138	Circuit 15 fuse (10 A)	1
		→	F140.3	Circuit 30 fuse (125 A)	2
		→	F143	Additional heater fuse (25 A)	1
		→	F148	Daytime running lamps relay fuse (10 A)	1
		→	F149	Roof AC fuse (40 A)	1
		→	F151	Fog lamp fuse (7.5 A)	1
		→	F153	Trailer socket fuse (25 A)	1
		→	F154	Instrument panel socket fuse (15 A)	1
		→	J327	Circuit 30 unfused connector sleeve	
		→	K26	Circuit D+ relay	1
J22	FWH/waistrail (next to firewall rubber grommet)	→	A12	Electrical center	4.7
	Circuit 15 fused connector sleeve	→	A62	WSP control unit	7
		→	H17	Horn	2
		→	K37	Horn relay	4
		→	K70	Circuit 15 relay for optional equipment	2
		→	K103	Circulation pump relay	3
		→	K138	Circuit 15 relay	2
		→	X79	Frame/waistrail connector	1
		→	X80	Frame/waistrail connector	3
J46	WWH (middle of instrument panel)	→	A9	Radio	1.A6
	Circuit 58 connector sleeve	→	A40	EWM control unit	2
		→	A71	Heater timer	1
		→	A81	Air conditioning pushbutton control and operating unit	1.9
		→	E104	Ashtray lighting	1
		→	S12	Driver seat heater switch	1
		→	S25	Headlamp range adjustment switch	9
		→	S48	ASR switch	1
		→	S57	Differential lock switch	1
		→	S81	Rear window defroster pushbutton	1
		→	S85	Driver interior lighting pushbutton	1
		→	S87	Auxiliary heater switch	1

		→	S90	Roof fan switch	1
		→	S92	Panic alarm button	1
		→	S99	ATA [EDW] towing/interior motion sensor button	1
		→	S100	Additional heat exchanger double-contact pushbutton	1
		→	S107	Front passenger seat heater switch	1
		→	S119.1	Fog light switch	1
		→	S124	Reading lamp switch	1
		→	S126	Interior pushbutton	1
		→	S137	Roof AC switch	1
		→	S138	Temperature switch	9
		→	X79	Frame/waistrail connector	2
		→	X234	Cigar lighter illumination plug connection	3
J58	WWH (middle of instrument panel)	→	A9	Radio	1.A4
	Circuit 30 connector sleeve	→	S87	Auxiliary heater switch	3
		→	X79	Frame/waistrail connector	8
		→	X234	Cigar lighter illumination plug connection	1
J105	WWH (middle of instrument panel)	→	A71	Heater timer	10
	Circuit 15 connector sleeve	→	A81	Air conditioning pushbutton control and operating unit	1.21
		→	S48	ASR switch	7
		→	S100	Additional heat exchanger double-contact pushbutton	3 8
		→	X79	Frame/waistrail connector	1
J302	WWH (close to heater timer A71)	→	A71	Heater timer	4 12
	Tml. 31 connector sleeve	→	W8	Ground point waistrail	
J337	FWH/seat frame (behind rubber grommet)	→	A82	EDW control unit	1.5
	ATA [EDW] blower stage connector sleeve	→	K75	Warm water auxiliary heater fan stage 1 relay	5
		→	X82	Frame/waistrail connector	14
		→	X194	ATA [EDW] connector	8
		→			

J372	FWH/waistrail (next to firewall rubber grommet)		P15	Instrument cluster	1.4
	Diagnostic cable connector sleeve	→	P17	Diagnostic socket 16-pin	15
		→	X82	Frame/waistrail connector	2
		→	X165	Warm water auxiliary heater connector, 8-pin	5
J377	FWH/waistrail (behind instrument cluster)	→	A12	Electrical center	4.1
	Circuit 30 connector sleeve	→	K103	Circulation pump relay	1
		→	X79	Frame/waistrail connector	3