



DID1 ECU

-

reference manual

Baldur Gíslason

July 16, 2022

# Contents

|        |   |    |
|--------|---|----|
| 1      | Introduction  | 4  |
| 1.0.1  | Terminology . . . . .                               | 5  |
| 2      | Wiring  | 8  |
| 2.1    | Pin-outs and description . . . . .                  | 8  |
| 2.1.1  | Pin numbering . . . . .                             | 8  |
| 2.1.2  | Connector 1 pin-out . . . . .                       | 8  |
| 2.1.3  | Connector 2 pin-out . . . . .                       | 8  |
| 2.1.4  | Connector 3 pin-out . . . . .                       | 9  |
| 2.1.5  | Connector 4 pin-out . . . . .                       | 10 |
| 2.1.6  | Connector 5 pin-out . . . . .                       | 12 |
| 2.2    | Wiring diagram . . . . .                            | 13 |
| 2.3    | Wiring guidelines . . . . .                         | 14 |
| 2.3.1  | What is required . . . . .                          | 14 |
| 2.3.2  | Plug and play Mercedes Benz configuration . . . . . | 16 |
| 2.3.3  | Grounding . . . . .                                 | 17 |
| 2.3.4  | 12V feed . . . . .                                  | 17 |
| 2.3.5  | Analog sensor inputs . . . . .                      | 19 |
| 2.3.6  | Injectors . . . . .                                 | 19 |
| 2.3.7  | Switching and PWM outputs . . . . .                 | 20 |
| 2.3.8  | Glow plugs . . . . .                                | 20 |
| 2.3.9  | MAP sensor . . . . .                                | 21 |
| 2.3.10 | Rail pressure sensor . . . . .                      | 21 |
| 2.3.11 | Temperature sensors . . . . .                       | 22 |
| 2.3.12 | Crank and cam position sensors . . . . .            | 22 |
| 2.3.13 | Pedal position sensor . . . . .                     | 22 |
| 3      | Software configuration                              | 24 |
| 3.1    | Getting started . . . . .                           | 24 |
| 3.2    | Performing firmware upgrades . . . . .              | 25 |
| 4      | Extended features                                   | 27 |
| 4.1    | Cruise control . . . . .                            | 27 |
| 4.2    | OBD2 communications . . . . .                       | 28 |
| 4.2.1  | Wiring . . . . .                                    | 28 |
| 4.2.2  | Standard OBD2 PIDs . . . . .                        | 28 |
| 4.2.3  | Custom OBD2 PIDs . . . . .                          | 29 |
| 4.2.4  | Transmitting data back . . . . .                    | 30 |

---

|   |  |     |
|---|--|-----|
| A | Error codes  | 31  |
| B | W210 E320 CDI wiring diagram for reference (OM613 engine)                  | 32  |
| C | W210 E220 or E270 CDI wiring diagram for reference (OM611 or OM612 engine) | 43  |
| D | W163 ML270 CDI wiring diagram for reference (OM612 engine)                 | 54  |
| E | Mercedes Benz OM648 wiring   | 66  |
| F | Mercedes Benz OM628 wiring   | 75  |
| G | Toyota 1KD-FTV wiring (early)  | 91  |
| H | BMW M57 wiring (E46/E39)   | 100 |
|   | H.1 Component wiring . . . . .   | 100 |
|   | H.2 Original ECU pinout . . . . .  | 104 |
| I | Ssangyong D27DT (OM665) wiring   | 107 |
|   | I.1 Component wiring . . . . .   | 107 |
|   | I.2 Factory wiring diagrams . . . . .                                      | 110 |

# 1 Introduction

DID1 is an engine control unit for common rail diesel engines with up to 8 cylinders equipped with solenoid injectors. It is also capable of driving unit injectors as well as some spill valve controlled injection pumps. The injector outputs have a programmable voltage boost to shorten the current rise time as well as a programmable current limit profile. Injectors can open multiple times per firing cycle but no two injectors can be open simultaneously.

Controllers sold after April 27th 2021 have a serial number from 200 and up and are a second generation design.

Notable hardware features:

**8 injector outputs** Software configurable boost voltage up to 100V.

Software configurable peak current up to 32A, high current phase up to 30A and hold current up to 21A. Controllers ordered for plug-and-play operation with Mercedes Benz OM61x engines have only 6 injector outputs. Previous generation controllers are without the high current phase in between peak and hold phases.

**15 configurable low-side switch outputs** 7 of which are PWM capable.

Previous generation has 11, with 7 PWM capable.

**1 configurable high-side switch output** As of serial number 300, there is one extra configurable output that switches +12V, added for easier compatibility with factory wiring on Toyotas which use +12V to trigger the glow heating relay.

**Dedicated main relay output** On first generation controller this was only for plug and play compatibility on Mercedes Benz applications. Later generations have a second ignition switch input and include the ability to delay shut down of the main relay for controlled engine shut off in applications that would otherwise have uncontrolled rail pressure while the engine spins down. Serial number 300 and up can also control a +12V switched main relay such as found on Toyotas.

**14 0-5V analog inputs** 2 of which are dedicated for accelerator pedal input. Of the rest, 2 have 3000 $\Omega$  pull-up resistors for thermistor bias, a further 2 can be configured between 57.6k $\Omega$  and 3000 $\Omega$  and the rest have 57.6k $\Omega$  pull-ups.

**8 general purpose digital inputs** Not counting crank/cam sensor inputs. 4 of these are frequency capable. All are 12V tolerant but

with 5V pull-ups. Inputs 1 and 2 have software configurable pull-down resistors so they can register positive voltage input. Previous generation has 5 digital inputs.

**1 K-type thermocouple input** Measurable range 0 to 1350°C. Previous generation has a range of 0 to 950°C.

**On board barometric pressure sensor**

**8 GB On board data logging memory** Capable of recording data at up to 1000Hz on selected channels or every channel at up to 500Hz.

**2 CAN 2.0B interfaces** Capable of sending and receiving arbitrary data as well as serve OBD2 over CAN. Data rates configurable up to 1Mbps.

**LIN bus interface** For control of turbocharger actuators and other devices relying on LIN networking.

**1 Analog output** 0-5V mappable to perform any function, perfect to provide a throttle or engine torque signal to transmission controllers or other devices not CAN-enabled.

**USB 2.0 for PC communication**

### 1.0.1 Terminology

Some terminology and abbreviations found in this manual:

**Analog input** An input on the ECU that accepts a variable voltage ranging from 0 to 5 volts and the ECU will record this voltage.

**BG Calibrator** The software used to communicate with and configure the ECU.

**CAN** Controller Area Network. A communications interface that allows multiple computers to communicate by joining them all to a shared single pair of wires, capable of speeds up to 1 megabit per second but the most common configuration being 500 kilobits per second. In CAN terminology, termination refers to the connection of a 120 ohm resistor between the pair of wires. Two terminations must be present on a CAN network for correct operation, and these terminations can be located inside devices on the network or by the means of resistors connected directly. For best signal integrity the terminations should be located on each end of the network if the wiring is long.

**Digital input** An input on the ECU that accepts a variable voltage ranging from about negative 30 volts to positive 30 volts but the ECU will only register whether this voltage is below positive 1 volt (active low state 1) or above positive 2.5 volts (state 0). Voltages in between 1.0 and 2.5 volts have an undefined state as hysteresis

prevents changing states inside that range. Many of the digital inputs can record the frequency of voltage swings or interval between state changes as a means of measuring speed (vehicle speed, turbocharger speed, fluid flow rate, etc).

**ECU** Electronic Control Unit. Sometimes called Engine Control Unit.

**Firmware** The software that is installed inside the ECU.

**Hall effect sensor** A sensor that utilises the so called hall effect phenomenon to sense magnetic fields. Typical application crankshaft speed sensing, camshaft position sensing or vehicle speed sensing. Most typically has a permanent magnet built in to the sensor allowing it to sense metal teeth on rotating wheels but variants also exist that use moving permanent magnets as their targets. These sensors have circuitry inside them and have three terminals. One terminal connects to ground, another to a voltage supply (5V typically) and the third is typically an open collector (low-side switching) output that activates when metal is present at the tip of the sensor. Certain sensors also exist that utilise the hall effect phenomenon to measure displacement or angle of a magnet, such as solid state accelerator pedal position sensors.

**LIN** Local Interconnect Network. A low speed single wire communications interface typically used for small single purpose devices like actuators or switches. Maximum data rate 20 kilobits per second.

**Low-side switch** An ECU output that provides negative voltage (ground) to the circuit when activated, conducts no current otherwise. Any device connected to such an output such as a relay or a solenoid must have its other terminal connected to a positive voltage supply such as the vehicle's battery.

**Main relay** The relay that switches on power from the vehicle's battery to the ECU.

**MAP** Intake Manifold Absolute Pressure. The air pressure in the engine's intake manifold measured in absolute pressure units.

**N/C** No Connection. Means a wire or pin to which no connection should be made. Care should also be taken to isolate the wire so its bare metal can not make any unintentional connections.

**Power ground** A pin on the ECU meant to carry large currents. These pins must be connected to a low impedance ground, preferably directly to the battery negative terminal.

**Pull down** A resistor that pulls the voltage of a circuit close to ground level by sinking a small amount of current. When no other connection is made to the circuit the circuit will float at or close to ground level (0 volts).

**Pull up** A resistor that lifts the voltage of a circuit above ground level by providing a small amount of current. When no other connection is made to the circuit the circuit will float at the same voltage as the pull up resistor connects to, otherwise the voltage will depend on the current sinking capability of the connected device.

**PWM** Pulse Width Modulation. Where an output is pulsed on/off rapidly and the ratio between on and off time effectively modulates the current flowing in the circuit as well as the force enacted by the actuator it controls.

**Sensor ground** A pin on the ECU meant for grounding sensors to. These pins must not be connected to any other grounds in the vehicle. If significant conductance (10 ohms or below) can be measured from a sensor ground pin to the vehicle's chassis ground when the ECU is disconnected from the harness then that indicates a wiring error.

**Thermistor** A type of temperature sensor that exhibits a variable resistance as a function of temperature. To measure the resistance of the sensor the ECU must feed current through it by the means of a suitably strong pull up resistor and measure the resulting voltage with an analog input. Since the sensor is dependant on a current supply for value measurement it is not good practice to splice sensor wiring with another controller as this will interfere with the measurements if both controllers are feeding current to the circuit.

**Thermo couple** A type of temperature sensor formed by a junction of dissimilar metals that generates a small voltage when the junction is at different temperature than the other end of the wire connecting them. Typical use in this application is for exhaust gas temperature measurement. For the most accurate operation these must be connected by special wiring that maintains the same metal alloy from the temperature probe all the way back to the interface device.

**Variable reluctance sensor (VR sensor)** A sensor with 2 terminals consisting of a metal core, a coil of wire and a permanent magnet. Typically used to sense crankshaft speed, vehicle speed or camshaft position (see also hall effect sensor). Typically one wire is connected to a sensor ground and the other connects to an ECU input. Bringing a piece of metal close to the sensor's tip produces a voltage pulse and moving the metal piece away from the sensor's tip produces a voltage pulse of the opposite polarity. Thus the polarisation of the sensor's wiring matters and the ECU will pick up some signal regardless of the polarity but if its timing is of importance (crank trigger) the wiring polarity must be correct for correct operation. The amplitude of the signal is a function of the speed of the object moving near the tip of the sensor.

## 2 Wiring

### 2.1 Pin-outs and description

#### 2.1.1 Pin numbering

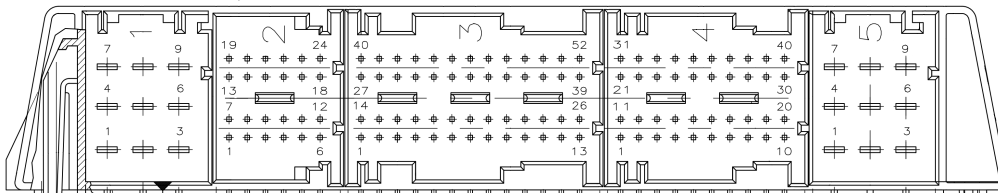

Figure 2.1: Connectors on the back of the controller and their pin numbering.

Below the function of each pin on the controller is listed. Any pins that have no internal connection are not listed.

#### 2.1.2 Connector 1 pin-out

| Pin | I/O | Function                   | Note    |
|-----|-----|----------------------------|---------|
| 1   | IN  | 12V supply for peripherals | 10A max |
| 4   | IN  | Power ground               |         |
| 5   | IN  | Power ground               |         |
| 6   | IN  | Power ground               |         |
| 7   | IN  | 12V supply for ECU         | 15A max |
| 8   | IN  | 12V supply for ECU         | 15A max |

#### 2.1.3 Connector 2 pin-out

Note that connector 2 is redundant, it has no functions that are not found elsewhere due to limited availability of the mating connector. The functions that are wired are only there for plug and play compatibility with Mercedes Benz OM61x plug and play applications.

| Pin | I/O | Function              | Note  |
|-----|-----|-----------------------|---|
| 11  | IO  | CAN 1 H               | Internally terminated, also present on pin 3-1                                  |
| 12  | IO  | CAN 1 L               | Internally terminated, also present on pin 3-2                                  |
| 13  | IN  | Ignition switch input | +12V switched to activate main relay. Also found on pin 3-31 on S/N 200 and up. |



## 2.1.4 Connector 3 pin-out

| Pin | I/O | Function            | Note   |
|-----|-----|---------------------|--|
| 1   | IO  | CAN 1 H             | Internally terminated, also present on pin 2-11  |
| 2   | IO  | CAN 1 L             | Internally terminated, also present on pin 2-12  |
| 3   | IO  | CAN 2 H             | Internally terminated  |
| 4   | IO  | CAN 2 L             | Internally terminated  |
| 5   | OUT | 5V reference output | 200mA max. Typically accelerator pedal position sensor.  |
| 6   | IN  | Thermo couple +     | K-type   |
| 7   | IN  | Thermo couple -     | K-type   |
| 8   | OUT | Sensor ground       | Typically accelerator pedal position sensor.   |
| 9   | IN  | Analog input 1      | Accelerator pedal secondary, 57.6k $\Omega$ pull up  |
| 10  | IN  | Analog input 0      | Accelerator pedal primary, 100k $\Omega$ pull down   |
| 12  | OUT | Output 9            | Low-side switch, 5A max  |
| 14  | IN  | Analog input 8      | 57.6k $\Omega$ pull up   |
| 15  | IN  | Analog input 9      | 57.6k $\Omega$ or 3k $\Omega$ pull up (software selectable)  |
| 16  | IN  | Analog input 10     | 57.6k $\Omega$ or 3k $\Omega$ pull up (software selectable)  |
| 17  | IN  | Analog input 11     | 57.6k $\Omega$ pull up   |
| 18  | OUT | 5V reference output | 200mA max  |
| 19  | OUT | Sensor ground       |  |
| 20  | IN  | Digital input 1     | Active low, 12V tolerant, 10k pull up or 1k pull down software selectable                                  |
| 21  | IN  | Digital input 2     | Active low, 12V tolerant, 10k pull up or 1k pull down software selectable. Not for frequency/speed input   |
| 22  | IN  | Digital input 3     | Active low, 12V tolerant, 10k pull up  |
| 23  | OUT | Sensor ground       | Typically accelerator pedal position sensor.   |
| 24  | IN  | Digital input 5     | Active low, 12V tolerant, 10k pull up  |
| 25  | OUT | Output 11           | Low side switch, 1A max, 4.7k pull up to 12V. Capable of bidirectional communication with glow plug relay. |
| 26  | IN  | Digital input 4     | Active low, 12V tolerant, 10k pull up  |

| Pin | I/O | Function                | Note   |
|-----|-----|-------------------------|--|
| 27  | IN  | Analog input 12         | 57.6k $\Omega$ pull up   |
| 28  | IN  | Analog input 13         | 57.6k $\Omega$ pull up   |
| 29  | IN  | Analog input 14         | 57.6k $\Omega$ pull up   |
| 30  | OUT | 12V accessory output    | 5A max   |
| 31  | IN  | Ignition switch input   | +12V switched to activate main relay. Only on S/N 200 and up.  |
| 32  | IN  | Digital input 8         | Active low, 12V tolerant, 10k pull up, only present on S/N 200 and up. Not for frequency/speed input but RS232 data capable (GPS NMEA or other purposes) |
| 35  | OUT | 12V accessory output    | 5A max. Typically turbocharger control solenoid.   |
| 37  | OUT | 12V accessory output    | 5A max   |
| 40  | OUT | 5V reference output     | 200mA max  |
| 41  | OUT | Sensor ground           |  |
| 42  | IO  | LIN bus                 | Shared with pin 4-32. Not advisable to use both at same time.  |
| 43  | OUT | Output 10               | Low-side switch, 5A max  |
| 44  | OUT | Main relay out positive | High-side switch, 1A max. S/N 300 and up only. <sup>1</sup>  |
| 45  | OUT | Analog output           | 0-5V out   |
| 46  | OUT | Main relay out negative | Low-side switch, 1A max  |
| 47  | IN  | Digital input 7         | Active low, 12V tolerant, 10k pull up. S/N 200 and up only   |
| 48  | OUT | Output 5                | Low-side switch, 5A max. Typically turbocharger control solenoid.  |
| 49  | OUT | Output 1                | Low-side switch, 5A max, 1k $\Omega$ pull up to accessory 12V. Tachometer output capable.  |
| 50  | OUT | Output 4                | Low-side switch, 5A max, flyback diode to accessory 12V.   |
| 51  | OUT | Output 7                | Low-side switch, 5A max  |
| 52  | OUT | Output 8                | Low-side switch, 5A max  |

### 2.1.5 Connector 4 pin-out

| Pin | I/O | Function            | Note   |
|-----|-----|---------------------|--|
| 1   | OUT | 5V reference output | 200mA max  |
| 2   | OUT | Sensor ground       | Typically cam position sensor                          |
| 3   | IN  | Cam sync input      | 2.2k $\Omega$ pull-up, 12V tolerant. Hall effect or VR |

<sup>1</sup>For main relay control, use one of the positive or negative outputs, the other leg of the relay coil must connect to ground or battery voltage respectively

| Pin | I/O | Function             | Note   |
|-----|-----|----------------------|--|
| 4   | OUT | Sensor ground        | Typically rail pressure sensor.  |
| 6   | IN  | Analog input 6       | MAP sensor input. 57.6k $\Omega$ pull-up   |
| 7   | OUT | Sensor ground        | Typically MAP sensor.  |
| 8   | OUT | 5V reference output  | Typically MAP sensor. 200mA max  |
| 10  | OUT | Output 2             | Low-side switch, 5A max  |
| 11  | OUT | 12V accessory output | 5A max   |
| 12  | OUT | 5V reference output  | 200mA max  |
| 13  | OUT | 5V reference output  | 200mA max  |
| 14  | IN  | Analog input 4       | Typically rail pressure sensor. 57.6k $\Omega$ pull-up   |
| 15  | IN  | Digital input 6      | Active low, 12V tolerant, 10k pull up. Only S/N 200 and up. Oil pan sensor on Mercedes.            |
| 17  | OUT | Sensor ground        | Only on S/N 200 and up   |
| 18  | OUT | 5V reference output  | 200mA max  |
| 21  | OUT | Output 3             | Low-side switch, 5A max, flyback diode to accessory 12V. Typically rail pressure control solenoid. |
| 22  | OUT | 12V accessory output | 5A max   |
| 23  | IN  | Analog input 3       | Typically charge air temperature sensor. 3k $\Omega$ pull-up                                       |
| 24  | IN  | Analog input 5       | 57.6k $\Omega$ pull-up.  |
| 25  | OUT | 12V accessory output | 5A max   |
| 26  | IN  | Crank trigger input  | 2.2k $\Omega$ pull-up, 12V tolerant. Hall effect or VR   |
| 27  | OUT | Sensor ground        | Typically coolant/air temperature sensors.   |
| 29  | OUT | Output 16            | High-side switch, 1A max, S/N 300 and up only <sup>2</sup>   |
| 30  | OUT | Output 15            | Low-side switch, 1A max, S/N 200 and up only   |
| 31  | OUT | 12V accessory output | 5A max. Typically rail pressure control solenoid.  |
| 32  | IO  | LIN bus <sup>3</sup> | Shared with pin 3-42. Not advisable to use both at the same time.                                  |
| 33  | OUT | Output 6             | Low-side switch, 5A max  |
| 34  | OUT | Sensor ground        |  |

<sup>2</sup>Voltage must not get back-fed in to switched +12V outputs, meaning if the output is paralleled with an override switch, a diode must be used to prevent feeding current back in to the output

<sup>3</sup>Only on first generation. Second generation controllers have the LIN bus brought out on pin 3-42 only

| Pin | I/O | Function       | Note  |
|-----|-----|----------------|---|
| 36  | IN  | Analog input 2 | Typically coolant temperature sensor. 3k $\Omega$ pull-up |
| 37  | OUT | Sensor ground  | Typically crank trigger.                                  |
| 38  | OUT | Output 12      | Low-side switch, 1A max, S/N 200 and up only              |
| 39  | OUT | Output 13      | Low-side switch, 1A max, S/N 200 and up only              |
| 40  | OUT | Output 14      | Low-side switch, 1A max, S/N 200 and up only              |

### 2.1.6 Connector 5 pin-out

| Pin | I/O | Function                 | Note  |
|-----|-----|--------------------------|---|
| 1   | OUT | Injector 8 negative      | Injector supply common on ECUs configured for OM611/OM612/OM613 plug and play |
| 2   | OUT | Injector 7 negative      | Injector supply common on ECUs configured for OM611/OM612/OM613 plug and play |
| 3   | OUT | Injector 6 negative      |   |
| 4   | OUT | Injector positive common |   |
| 5   | OUT | Injector 1 negative      |   |
| 6   | OUT | Injector 4 negative      |   |
| 7   | OUT | Injector 3 negative      |   |
| 8   | OUT | Injector 2 negative      |   |
| 9   | OUT | Injector 5 negative      |   |

## 2.2 Wiring diagram

Work in progress.

## 2.3 Wiring guidelines

### 2.3.1 What is required

The minimum required wiring to run an engine consists of the following. All of the described sensors and actuators should be already present if you have a complete car with engine but some may be missing if you just have the engine by itself.

#### **Main relay**

Controls power to the ECU. Most OEM wiring harnesses have this already. The ECU should not receive its power from the ignition switch but rather there should be a relay that switches it on using a dedicated fused feed from the battery. See 12V feed section further down this chapter.

#### **Crankshaft position sensor (crank trigger)**

Supplies the ECU with information about the engine's rotational speed as well as the angle of the crankshaft. The recommended trigger wheel tooth count is 60 with two removed. If wheel diameter is limited, as few as 36 teeth may be used with one or two removed. Fewer than this can work but are not recommended as diesel engines are highly sensitive to the accuracy of the injection timing and can have high rates of crankshaft acceleration. Variable reluctance or hall effect sensors can be used. Some low output variable reluctance sensors require extra amplifier modules to be installed inside the controller. The crank position sensor has a dedicated input on connector 4 pin 26.

#### **Camshaft position sensor (cam sync)**

Supplies ECU with information on the phase of the cam shafts. Required during start up to match crank angle to the firing order on a 4 stroke engine. Variable reluctance or hall effect sensors can be used. Some low output variable reluctance sensors require extra amplifier modules to be installed inside the controller. The cam position sensor has a dedicated input on connector 4 pin 3.

#### **Rail pressure sensor**

If using a common rail engine, a rail pressure sensor is required for control over fuel rail pressure as well as computing the correct pulse width to deliver the commanded fuel quantity. The rail pressure sensor can connect to any analog input, the default is analog input 4, connector 4 pin 14.

#### **Rail pressure control solenoid**

Most common rail engines utilise some kind of solenoid for computer control of rail pressure. In some instances more than one solenoid. These are most typically located on the high pressure fuel pump but sometimes on the fuel rail itself. In the case of proportioning valves (most common) they should be connected to the high current PWM

outputs (outputs 3 or 4). In the case of synchronised suction valves they would connect to outputs 9 or 10.

### **Fuel injectors**

This controller operates solenoid valve type injectors. These are the most common injectors found on common rail diesel engines. To distinguish solenoid valves from the less common but still common piezoelectric valves, set a multimeter to measure resistance in the range closest to 0 ohms. A solenoid will read less than 10 ohms continuously, a piezoelectric actuator will measure open circuit (no conductivity).

### **Accelerator pedal**

Not required to start the engine but required to operate above idle speeds. The accelerator pedal wiring must be uncompromised with no connection to other devices than the ECU and preferably not shared with other sensors. The accelerator pedal should preferably be of dual potentiometer or solid state type with dual analog voltage outputs. Potentiometer + idle switch as commonly found on older diesel cars may also be used.

Components that are not as such required for start up but recommended for normal operation:

### **Intake Manifold Absolute Pressure sensor**

Required for turbocharger control as well as limiting fuel during transient conditions. The MAP sensor has a dedicated input which is analog input 6 (connector 4 pin 6).

### **Coolant temperature sensor**

The engine's characteristics are different when cold than when it is at operating temperature so best cold start and cold idle behaviour can not be achieved without coolant temperature data. Coolant temperature data is also required for automated control of glow plugs and cooling fans. There is not a dedicated input for the coolant temperature sensor but the default is analog input 2 (connector 4, pin 36).

### **Charge air temperature sensor**

The density of the air is a function of air temperature, and while a diesel can tolerate large variations in oxygen to fuel ratio it is a good idea to have a charge air temperature sensor to compensate for air temperature and avoid overfuelling on a hot day with a heat soaked intercooler.

### **Glow plug relay**

If the engine in question has glow plugs or other means of heat assisted cold starts, the ECU can control this. Two types of control are supported, a standard general purpose relay or a Mercedes Benz PWM glow controller as found on any electronically controlled Mercedes Benz diesel engine from 1996 until about 2006, with

4, 5, 6 or 8 cylinders. The same units have been found on some Volkswagens and possibly more cars that are not Mercedes Benz. PWM refers to the communications protocol these controllers use to communicate with the ECU, they do not employ pulse width modulation as a means of controlling glow plug temperature. A traditional relay can be controlled by any of the programmable outputs but a PWM glow controller should use output 11 (connector 3 pin 25) as that pin provides bidirectional communications allowing diagnostics of glow plug performance.

### **Turbocharger control**

The DID1 ECU can control turbochargers, either with variable geometry or wastegates. Single, dual or even triple turbochargers, parallel or compound. In most instances this is done by PWM control and requires a solenoid valve to modulate the vacuum or pneumatic pressure on the actuator diaphragm. Programmable outputs 5 through 8 are typically used to perform this function. For electronic VGT actuators the method of control varies. Some use PWM control while others require CAN bus communication or even LIN bus communication. The DID1 ECU can support all of these but at the time of writing no LIN bus turbo actuator protocols have been coded.

### **Lift pump**

This is an area where engines vary wildly, some have a mechanical low pressure lift pump integrated or attached to the high pressure pump. Others require an electric lift pump to feed the high pressure pump.

## **2.3.2 Plug and play Mercedes Benz configuration**

The controller is designed to be plug and play for Mercedes Benz OM611, OM612, OM613 engines. However due to some differences between the wiring of different chassis containing these engines some modifications to the car's wiring may need to be done. The controller is designed to be fully plug and play for a W210 E320 CDI, other cars may need modifications. In the case of the W163 ML270 CDI, W210 E220 CDI, W210 E270 CDI or other cars with OM611 or OM612 engines the following wires need to be moved around:



| OEM pin | DID1 pin | Colour | Note   |
|---------|----------|--------|--|
| 3-22    | 4-7      | green  | MAP sensor ground  |
| 3-17    | 4-8      | red    | MAP sensor +5V   |
| 3-6     | 4-6      | orange | MAP sensor signal  |
| 3-31    | 3-37     | blue   | M class only: Electric fan +12V switched (may be substituted for other +12V accessory pin)                       |
| 3-45    | 3-52     | orange | M class only: Electric fan PWM control from switching output 8   |
| 3-1     | 4-27     | blue   | Sensor ground for charge air temperature sensor. May substitute other sensor ground pin or splice existing wire. |
| 3-12    | 4-23     | orange | Charge air temperature sensor to analog input 3  |
| 3-40    | N/C      | blue   | Remove wire to avoid interfering with on board diagnostics   |
| 3-28    | N/C      | orange | Remove wire to avoid interfering with on board diagnostics   |

### 2.3.3 Grounding

The controller should be connected to the battery negative terminal or another reliable grounding point by a no less than three 1.5 mm<sup>2</sup> (14-16 AWG) wires running in parallel. Length of ground wires should be kept as short as practical. An improper ground connection will cause electrical noise and possibly faults with controller operation.

Any sensors connected to the ECU must not be grounded elsewhere than to the ECU's sensor ground pins unless they are isolated circuits. Under no circumstance whatsoever may the controller's sensor ground pins be connected to any wiring that already has a connection to any other ground point in the vehicle at the risk of degraded sensor signal integrity and controller damage.

### 2.3.4 12V feed

The controller requires no less than two 1.5 mm<sup>2</sup> (14-16 AWG) running in parallel or a single 2.5 mm<sup>2</sup> (12 AWG) to the battery positive terminal through a fuse or circuit breaker and a relay. Power is to be fed into pins 7 and 8 of connector 1 and the circuit should be fused at 15-20A. Keep wiring as short as possible to limit electrical noise and voltage drop. A secondary supply for external accessories must also be wired for correct operation. This supply goes to pin 1 of connector 1 and should be fused at 10A if you are using the accessory power output pins on the ECU. If you are not using the accessory power output pins but rather the accessory power is distributed from elsewhere this fuse may be omitted but under no circumstance may the 12V connection to pin 1 be omitted.

If your ECU is the first generation (serial number below 200) it does not have software control of main relay or ignition switch status detection. This is fine as long as the ECU is being used on a fuel system that does not utilise a normally open suction control valve such as found on the Bosch CP3 high pressure pump and many others from other manufacturers. If this suction control valve is the only device controlling rail pressure then pressure will spike to the maximum the pump is capable of delivering if power is removed from the ECU before the engine has come to a stop. This is liable to cause damage to fuel system components if allowed to persist long term. The work around if using an older ECU on such a fuel system is to connect the ignition switch to a digital input for the ECU to detect and use a programmable output to keep the main relay energised until engine speed is zero.

ECUs with a serial number of 200 and up have software control of main relay built in and as of firmware version 1.8 the use of this feature is enforced as it has been discovered that if conditions are just wrong, damage can occur to ECU or fuel system components during engine shut down if not controlled. If you are using the ECU in a plug and play installation in a Mercedes Benz car, truck or van the main relay is already wired correctly from the factory, using pin 2/13 as an ignition switch input and 3/46 for main relay control output.

In any other application, you must ensure the correct wiring of the main relay or damage to the fuel system or ECU is possible. The correct wiring is as follows:

**Ignition switch output** Connects to pin 3/31 or if connector 2 is present, pin 2/13 can also be used. 3/31 is provided as an alternative on newer ECUs (S/N 200 and up) as the connector shells for connector 2 are not readily available.

**Main relay common (terminal 30)** Goes directly to battery positive, via a fuse.

**Main relay contact (terminal 87)** Goes to connector 1 pins 7, 8 and 1.

**Main relay coil positive (terminal 86)** Join to same battery positive connection as terminal 30.

**Main relay coil negative (terminal 85)** Connect to pin 3/46 on DID1.

If you are using the ECU in a motorsport application that requires an emergency shut off switch, the main relay for the ECU must still get its terminal 30 and terminal 86 power directly from the battery. The ignition switch input should come from the side that is isolated from the wiring harness. If you have other opinions please contact us to discuss your options to ensure reliable operation.

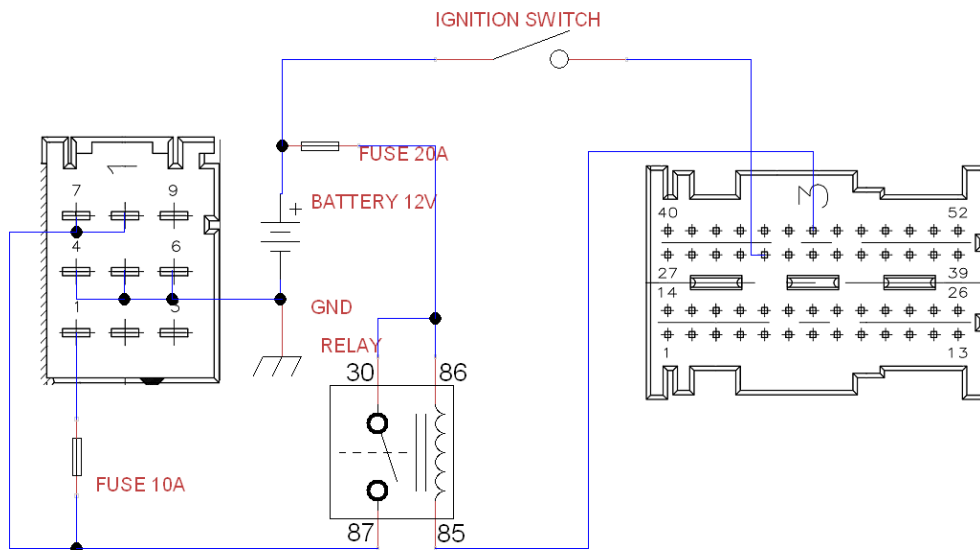

Figure 2.2: Correct power supply wiring for controllers with serial numbers 200 and up.

If you have an older ECU (S/N below 200) and need to use a fuel system whose pressure is controlled solely by a normally open suction control valve, contact us for advice on setting up main relay control with delayed shut off.

### 2.3.5 Analog sensor inputs

The analog sensor inputs have an input range from 0 to 5 volts. Under no circumstance may these inputs have voltages below 0 volts or above 5 volts supplied. Although the inputs are protected against damage in such situations the signal integrity of all analog inputs is compromised when any of the inputs are receiving voltage outside of the design range. For the greatest accuracy and repeatability, sensors that output an analog voltage should use the 5 volt reference outputs provided by the controller.

### 2.3.6 Injectors

If the ECU is ordered as a plug and play unit for Mercedes Benz OM61x engines there will be three pins providing positive voltage to the injectors. If the ECU is ordered in the 8 cylinder capable version it will have just one pin supplying positive voltage to the injectors and the other two pins become negative outputs for injectors 7 and 8.

For best performance the positive and negative wires for each injector should be twisted together all the way from the injector and the positive supply wires for the injectors should be joined close to the ECU. It is important to have very low resistance in the injector wiring so the wires should not be made longer than they need and they should use heavy gauge conductors. In any case no smaller than 1.5 mm<sup>2</sup> (14-16 AWG) as the resistance and inductance of these wires has an effect on the injectors ability to open quickly. An exception can be made for injectors that

require less than 10A peak current. Those can be wired with smaller gauge wiring.

Excessive resistance in the injector wiring increases losses in the system and thus overall load on injector power supply circuit.

### 2.3.7 Switching and PWM outputs

The ECU has eleven programmable outputs and while all low speed functions are applicable to every output, some PWM functions have dedicated outputs. This means that if those functions are used, they can only be assigned to the specified output. The outputs are low-side switches meaning the negative terminal of whatever device that is to be switched on is wired to the controller. The outputs are rated for 3A continuous current and 5A intermittent with the exception of output 11 so anything that draws more current must be wired through a relay. All outputs except 3 and 4 have a 30 volt flyback voltage clamp built in but may need an external flyback diode for high current high frequency PWM operation.

Pins 4-21 (Output 3) and 3-50 (Output 4) have flyback current diodes restricting flyback voltage to supply voltage, making them suitable for continuous PWM operation of loads greater than 1A current and greater than 100Hz. This also makes them unsuitable for switching accessories that are live when the supply to the ECU is switched off. Outputs 1 and 11 have pull-up resistors so their connection to devices that have constant power should be evaluated first, the exception to this is something like the Mercedes Benz smart glow plug relay which does not pull the data line high by itself even though the glow relay is powered directly off the battery.

### 2.3.8 Glow plugs

The ECU can control any standard glow plug relay as well as Mercedes single wire smart glow relay. The glow plugs are normally controlled by output 11, pin 3-25. Note that this output pin is not rated for current greater than about 1A so make sure the relay being used does not have a coil resistance of less than 12 ohms or use a different pin if this is not the case.

The Mercedes smart relay has a few connections. An M6 stud that connects directly to the battery positive terminal. A big connector with 6 pins that connects to the glow plugs. The same relay fits 4, 5 or 6 cylinder engines, 4 or 5 cylinder engines will just leave some pins unused.

Then there is a small connector with three pins. The pin terminals are labeled 31 for ground, DL for data link and TK which is not used. The ground wire is brown and the data link wire in the middle is usually white but sometimes uses other colours.

To control the Mercedes glow relay, the output used must be configured for `PWM glow control` in the Calibrator software. If using a modified Mercedes relay or using any general purpose relay, select the `Glow control` setting for the output.

Control of the Mercedes glow relay is only precise to the nearest second or so. If heating time of less than 1 second is specified the relay may not turn on at all.

The output used to control the Mercedes smart relay must have a 12V pull-up. The ECU has built in pull ups on outputs 1 and 11.

Output 11 has the ability to do bidirectional communication with the Mercedes Benz glow relay, if this output is used for communicating with the relay the ECU can detect and report the health of each individual glow plug. When a defective plug is detected the glow indicator will flash rapidly for a few seconds after glow plug preheating has ended and the Calibrator application will list glow plug errors in the controller error list found under the **Communications** menu.

### 2.3.9 MAP sensor

The ECU expects the intake manifold absolute pressure sensor to be connected to input 6 (connector 4 pin 6). Typically the MAP sensor will also take 5V power from pin 4-8 and sensor ground from pin 4-7.

If using a 4 bar GM style MAP sensor such as the one sold in the web shop, the table below describes its wiring:



| MAP pin | Function      | ECU pin |
|---------|---------------|---------|
| A       | sensor ground | 4/7     |
| B       | signal        | 4/6     |
| C       | +5V feed      | 4/8     |

If using a cylindrical MAP sensor such as the 5, 6 or 10 bar units sold in the web store, the wiring is as follows. Note that pins are labeled as if looking into the connector on the sensor itself.

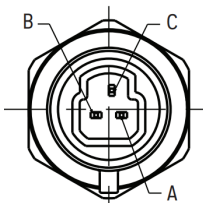

| MAP pin | Function      | ECU pin |
|---------|---------------|---------|
| A       | sensor ground | 4/7     |
| B       | +5V feed      | 4/8     |
| C       | signal        | 4/6     |

### 2.3.10 Rail pressure sensor

The fuel rail pressure sensor does not have a dedicated input but typical connection is analog input 4 (pin 4-14) with 5V supply taken from pin

4-13 and sensor ground at pin 4-4.

### 2.3.11 Temperature sensors

The temperature sensors do not have dedicated inputs but two analog inputs are provided that have a non-configurable 3 kilo ohm pull up resistor to them. Typical usage is to wire the coolant temperature sensor to analog input 2 (pin 4-36) and charge air temperature sensor to input 3 (pin 4-23) with sensor ground pins 4-27 and 4-34 used for return. Analog inputs 10 (pin 3-16) and 11 (pin 3-17) have a software controllable 3 kilo ohm pull up associated with them so these can be used to connect thermistors as well.

### 2.3.12 Crank and cam position sensors

For the crank and cam position sensors, both variable reluctance and hall effect type sensors are supported.

The crank position sensor has a dedicated input on pin 4-26 and a sensor ground on pin 4-37. If using a hall effect sensor it will need a 5V supply, this would typically come from pin 4-1 or 4-12.

The cam position sensor has a dedicated input on pin 4-3 and typically uses sensor ground pin 4-2 and +5V supply from pin 4-12.

### 2.3.13 Pedal position sensor

The ECU can utilise either single potentiometer with idle switch as found on most older electronically controlled diesels (including Mercedes OM60x) as well as dual potentiometer and solid state units.

It is highly recommended that the pedal wiring is of uncompromised integrity, with no branches to other devices, only connecting directly from the ECU to the accelerator pedal and not sharing these signals with any other devices in the car. If you require an accelerator position signal for another device such as a transmission computer, sharing the signal via CAN bus is the preferred option but if that is not possible the DID1 ECU provides an analog output that can be configured as a function of the accelerator pedal position.

| PPS pin | Wire colour   | Function          | ECU pin |
|---------|---------------|-------------------|---------|
| 1       | blue/green    | primary 5V feed   | 3-5     |
| 2       | brown         | secondary ground  | 3-23    |
| 3       | blue/grey     | secondary 5V feed | 3-5     |
| 4       | violet/yellow | secondary signal  | 3-9     |
| 5       | violet/green  | primary signal    | 3-10    |
| 6       | blue          | primary ground    | 3-8     |

Figure 2.3: Wiring for Mercedes W210 OM60x diesel accelerator pedal position sensor. Round body, part number A0115428617

| PPS pin | Wire colour   | Function         | ECU pin |
|---------|---------------|------------------|---------|
| 1       | blue/brown    | 5V feed          | 3-5     |
| 2       |               | no connection    |         |
| 3       | brown/white   | sensor ground    | 3-8     |
| 4       | violet/yellow | secondary signal | 3-9     |
| 5       | violet/green  | primary signal   | 3-10    |
| 6       | brown/yellow  | sensor ground    | 3-23    |

Figure 2.4: Wiring for Mercedes W210 petrol engine or common rail accelerator pedal position sensor, part number A0125423317 and others. Also found on other chassis.

| PPS pin | Wire colour   | Function         | ECU pin |
|---------|---------------|------------------|---------|
| 1       | blue/brown    | 5V feed          | 3-5     |
| 2       | violet/green  | primary signal   | 3-10    |
| 3       | brown/yellow  | sensor ground    | 3-23    |
| 4       | brown/white   | sensor ground    | 3-8     |
| 5       |               | no connection    |         |
| 6       | violet/yellow | secondary signal | 3-9     |

Figure 2.5: Wiring for Mercedes W204 or W211 electronic pedal, part number A2043001204. This model has a connector with a single row of pins. This pin-out also applies to the pedal found on late model Sprinters with common rail engines but wire colours are different on the Sprinter.

| PPS pin | Wire colour | Function         | ECU pin |
|---------|-------------|------------------|---------|
| 1       | blue/red    | 5V feed          | 3-5     |
| 2       | brown/blue  | sensor ground    | 3-23    |
| 3       | blue/green  | primary signal   | 3-10    |
| 4       | brown/grey  | sensor ground    | 3-8     |
| 5       | grey/green  | secondary signal | 3-9     |

Figure 2.6: Wiring for Mercedes Sprinter T1N common rail pedal with 5 pin connector

## 3 Software configuration

Refer to [BG calibrator manual](#) for introduction to the PC application.

### 3.1 Getting started

It is advised to leave the injectors disconnected until correct operation of rail pressure control, crank trigger and accelerator pedal has been verified. The default configuration has the configurable outputs all disabled to avoid conflict with different cars after firmware upgrade. It is advised to check for firmware updates from the web site prior to first start, see the next section for information.

In any case, see if a base map for your engine is available from vendor before you start this process, it is a lot easier to start up with a base map that is already configured for your engine.

Steps to perform before starting engine:

1. Check accelerator pedal operation. Verify that `app` variable reads less than 0.0% when the pedal is released and that it reacts to movement of the pedal.
2. Check that rail pressure reads close to 0 when engine is stopped on a common rail application. Applications without a rail pressure sensor (not common rail) should set the minimum rail pressure to allow starting to 0.0 bar in the Starting section of the configuration.
3. Check that temperature sensors are operating, check variables `airtemp` and `coolanttemp` read reasonable values and perform calibration if they do not. These temperature sensors are not absolutely essential to operation of the engine so if they read incorrectly that may be put aside to be solved after first start up.
4. Check that the correct number of cylinders, firing order and injector output assignment is configured. Some common engines are found in the configuration presets (found in the Tools menu at the top of the screen in Calibrator).
5. Configure the programmable outputs, the presets (found in the Tools menu as configuration presets) are a good starting point.
6. Check that ignition switch and main relay are working, ECU powers on and off again when required. If ECU remains powered on it will



be difficult to stop the engine and this must be rectified before attempts are made to start the engine.

7. Verify correct operation of crank trigger. Run starter with injectors (connector 5) disconnected and verify that the Calibrator software displays engine speed as well as `syncstate` variable having a value of 7 after the starter has operated for a couple of seconds and that a steady but slightly varying engine speed is displayed while cranking.
8. Verify correct operation of rail pressure control. This can be done at the same time as the previous step. Run the starter with no injectors connected and see that the `railpressure` variable climbs after starting for a while and then finally settles on a stable value that is not greater than the `railtarget` variable. If there is air in the fuel system it may take a minute of cranking before rail pressure is observed and controllable. This step does not apply to applications other than common rail engines.
9. Now is a good idea to record an event log while cranking the engine and verify that the firing order and injection timing looks correct. This is done from the logging menu at the top of the screen of the Calibrator software. The ECU must be connected and another data log must not be in progress to enable this option.
10. If problems are observed, rectify them before continuing. Contact technical support for advice if anything is not clear.
11. Connect injectors and attempt to start engine.

## 3.2 Performing firmware upgrades

Whenever new features are introduced, new firmware becomes available for download at <https://controls.is/firmware/>. See the release notes if you are unsure of whether you should update or not.

To perform a firmware upgrade:

1. Download firmware package from web site
2. Unzip firmware package into a directory on your hard drive
3. Connect USB cable between ECU and PC.
4. Power on ECU, do not start engine.
5. If you do not have the configuration backed up, run BG Calibrator, read configuration from ECU and save to file. This step may be skipped if you are performing the upgrade on an ECU you haven't made any previous configuration changes to.
6. Run `upgrade.cmd` in directory where firmware files are located.
7. Wait until the upgrade application finishes, should be on the order of 10 seconds.

8. Power ECU off.
9. Do not power ECU back on until you are ready to upload configuration to it.

The ECU has been upgraded but now contains the default configuration. If you are proceeding with default configuration, simply open the default configuration file for the new firmware in BG calibrator and go on-line. Otherwise, if you wish to retain your previous configuration, which is generally recommended, perform the following steps:

1. Run the BG Calibrator software
2. Open your old configuration file
3. Select **File -> Convert configuration** from the menu bar.
4. Select the configuration included with the new firmware in the file dialog.
5. The configuration has now been converted to the new format, save it and the Calibrator software will restart.
6. Review the settings and verify that they make sense, see release notes for information about what settings may need revisiting.
7. Go on-line and power on the ECU. Do not start engine.
8. When prompted, select to use local settings, which will then be uploaded to the ECU.

After the configuration has been sent to the ECU and Calibrator application becomes responsive again, power the ECU off and then back on. Now you can start the engine.

## 4 Extended features

### 4.1 Cruise control

The cruise control requires three switches wired multiplexed into any analog input through different value resistors to ground or alternatively from a CAN bus source. Typically the resume/accel switch goes via 22k $\Omega$  resistor to ground, the set/decel switch goes via 10k $\Omega$  resistor to ground and a cancel switch directly to ground with no added series resistance. For best results these switches should ground to a sensor ground on the controller. For cancel input, one should at least have a brake pedal switch (or relay actuated from the brake light circuit) but may also have others wired in parallel such as a clutch switch and/or hand operated cancel switch. For automatic transmission applications, a vehicle speed input is necessary for cruise control operation. For manual transmission applications it is recommended that the vehicle speed input is wired for safety reasons (blocking cruise control from engaging below a certain vehicle speed) but not strictly necessary. If a visual indicator is desired when the cruise control is active, use one of the general purpose outputs and set a condition to turn on when `flag_cruise = 1`. For smooth operation of the cruise control, the road speed signal must be reasonably clean. If you are seeing variations of several km/h indicated when holding a steady speed you may be able to correct that using the VSS smoothing and pulse averaging functions.

The cruise control has a number of outputs that are of interest in the real time data feed.

**cruisethrottle** Throttle input from cruise control function.

**cruiseP, cruiseI, cruiseD** Cruise control PID loop output.

**flag\_cruise** Indicator that cruise control is active.

**cruiseswitch** State indicator for cruise control switches.

| Value | Description                |
|-------|----------------------------|
| 0     | No switch active           |
| 1     | Stop switch active         |
| 2     | Set/decel switch active    |
| 3     | Resume/accel switch active |

## 4.2 OBD2 communications

It is possible to perform OBD2 over CAN bus communications with the ECU on CAN bus 1. This enables the use of accessories that can display OBD2 data for instrumentation purposes (various OBD2 gauges, mobile phone applications and scan tools) as well as diagnostic trouble code readout. The protocol implemented is ISO15765-4 11 bit OBD over CAN. To enable this functionality, the following configuration parameters must be set:

**CAN bus data mode** 500kbit

**CAN receiving enable** Enabled

**OBD2 service enable** Enabled

For diagnostic trouble codes, see Appendix A

### 4.2.1 Wiring

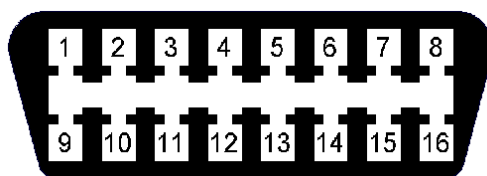

Figure 4.1: OBD2 female connector as seen from the end the scan tool plugs in to.

The OBD2 connector has four essential connections. Pin 6 (CAN-H) . Pin 14 (CAN-L) . Pins 4 and 5 connect to ground (any chassis ground will do) and pin 16 connects to +12V. The standard specifies that the +12V should be taken through a fuse directly from the battery but most OBD2 devices will also perform correctly if the 12V source is switched. For correct operation it may be necessary to have a 120 ohm termination resistor connected across the CAN wires if there is none connected to the CAN bus already.

### 4.2.2 Standard OBD2 PIDs

This is a list of the standard OBD2 PIDs the ECU reports:

| PID  | Description                             |
|------|---|
| 0x05 | Engine coolant temperature              |
| 0x0B | Manifold absolute pressure 0 - 2550mbar |
| 0x0C | Engine speed                            |
| 0x0D | Vehicle speed 0 - 255 km/h              |
| 0x0E | Main injection angle cylinder 1         |
| 0x0F | Charge air temperature                  |
| 0x11 | Effective accelerator pedal position    |
| 0x1F | Time since engine start                 |
| 0x23 | Fuel rail pressure                      |
| 0x24 | Lambda sensor 1                         |
| 0x25 | Lambda sensor 2                         |
| 0x33 | Barometer                               |
| 0x42 | Supply voltage                          |
| 0x5A | Accelerator pedal actual position       |
| 0x5C | Engine oil temperature                  |
| 0x5E | Fuel flow rate                          |
| 0x78 | Exhaust temperature sensors 1-4         |
| 0x79 | Exhaust temperature sensors 5-8         |

### 4.2.3 Custom OBD2 PIDs

The ECU already implements nearly every standard OBD2 PID that is applicable to this application, but there are plenty of common sensors for which there is no documented standard OBD2 PID (for example, oil pressure) and also lots of examples of the ECU being used to monitor custom sensors. To facilitate this, custom OBD2 PIDs have been provided. The custom PIDs can be used to add PIDs and they can also override existing PIDs if desired. For a list of defined standard PIDs see [https://en.wikipedia.org/wiki/OBD-II\\_PIDs](https://en.wikipedia.org/wiki/OBD-II_PIDs)

It is safe to define custom PIDs in the range of 197 up to 223 (0xC5 to 0xDF in hex) without conflicting with any predefined PIDs.

In the Torque app, the OBD2 command to retrieve these values is 01 succeeded by the PID in hex, so to get PID 197 for example it would be 01 C5 OBD2 specifies the data is always in big-endian format meaning the most significant byte comes first, so the following data types are provided, but for most scenarios it is recommended to stick to either u8 or u16be:

**bit** Single bit to indicate a status, 1 or 0. Treat the same as a u8 byte but with only 2 possible values. Example formula in Torque app: A

**u8** Single unsigned byte ranging from 0 to 255. Example formula in Torque app: A

**s8** Single signed byte ranging from -128 to 127. Example formula in Torque app: SIGNED(A)

**u16be** 2 byte 16 bit unsigned integer ranging from 0 to 65535. Example formula in Torque app: `INT16(A:B)`

**s16be** 2 byte 16 bit signed integer ranging from -32768 to 32767. Not simple to use in Torque app, use unsigned value and offset it using input/output scaling on ECU instead.

**u32be** 4 byte 32 bit unsigned integer ranging from 0 to 4294967295. Example formula in Torque app: `INT32(A:B:C:D)`

**s32be** 4 byte 32 bit signed integer ranging from -2147483648 to 2147483647. Not simple to use in Torque app, use unsigned value and offset it using input/output scaling on ECU instead.

#### 4.2.4 Transmitting data back

The ECU provides a set of remotely manipulable bits that can be used to trigger things on or off, switching calibrations, etc. These bits can be manipulated by Calibrator scripts using the remote procedure call `remotebit` or using OBD2 commands.

To access the remote bits from OBD, use the `AA` command. The command takes 2 arguments. First argument is the bit number, from 00 to 07 and the second argument is the action to perform. The possible actions are:

**00** Flip bit to 0 state.

**01** Flip bit to 1 state.

**02** Toggle bit between states.

**03** Do nothing, just return current value.

**04** Flip bit to 1 momentarily and then back to 0 about half a second later.

The `AA` command sends a reply on channel `EA` with two data bytes, the first data byte being the bit number that was accessed and the second data byte being the new state of that bit. To read the status of a bit using a custom PID in Torque, send the command `AA 00 03` where `00` is the bit you wish to read. The formula for the return data is simply `B`. To alter a bit from Torque create a push button widget that sends a raw OBD command, for example `AA 00 02` to toggle bit 0 between states each time you push the button.

Manipulating these bits from a Calibrator script can be done in a similar manner. Example:

```
[ "rpc", "remotebit", [ 0, 2 ] ] to toggle bit 0.
```

## A Error codes

The error codes are stored on three bit masks, error0, error1 and error2, as described in the previous chapter. They can be read using the Calibrator application (**Communication -> View controller errors** in on-line mode, **Tools -> Decode error variables** in log view mode). It is also possible to read the errors using an OBD2 scan tool if OBD2 connector is wired and OBD2 communications are enabled in the configuration. OBD2 DTC codes take the form of **P3XZZ** where X is the error variable, 0 for error0 and so on and ZZ is the bit offset in that variable, starting with 00. Note that these codes do not correspond with any auto manufacturer's codes.

Errors that prohibit engine starting:

## B W210 E320 CDI wiring diagram for reference (OM613 engine)

**Document number:** pe07.16-p-2000-99ed  
**Document title:** Wiring diagram of common rail diesel injection (CDI)

| <b>Code:</b> | <b>Designation:</b>                             | <b>Coordinates:</b> |
|--------------|---|---------------------|
| B11/4        | Coolant temperature sensor                      | 11 L                |
| B17          | Intake air temperature sensor                   | 10 L                |
| B2/5         | Hot film MAF sensor                             | 20 L                |
| B28          | Pressure sensor                                 | 22 L                |
| B4/6         | Rail pressure sensor                            | 9 L                 |
| B40          | Oil sensor (oil level, temperature and quality) | 14 L                |
| B6/1         | Camshaft Hall sensor                            | 15 L                |
| L5           | Crankshaft position sensor                      | 16 L                |
| M55          | Inlet port shutoff motor                        | 12 L                |
| N3/9         | CDI control module                              | 4 A                 |
| N3/9         | CDI control module                              | 12 A                |
| N3/9         | CDI control module                              | 20 A                |
| Y74          | Pressure regulator valve                        | 17 L                |
| Y75          | Electrical switch-off valve                     | 18 L                |
| Y76          | Injectors (LH-SFI, HFM-SFI, PEC [LH, HFM, PMS]) | 3 L                 |
| Y76y1        | Injector cylinder 1                             | 1 L                 |
| Y76y2        | Injector cylinder 2                             | 4 L                 |
| Y76y3        | Injector cylinder 3                             | 2 L                 |
| Y76y4        | Injector cylinder 4                             | 5 L                 |
| Y76y5        | Fuel injector cylinder 5                        | 6 L                 |
| Y76y6        | Fuel injector cylinder 6                        | 8 L                 |
| Z15          | Connector sleeve 7                              | 13 H                |
| Z6/8         | Sensor ground connector sleeve                  | 11 H                |
| Z99/6        | Common rail solenoid valve 1 connector sleeve   | 2 H                 |
| Z99/7        | Common rail solenoid valve 2 connector sleeve   | 6 H                 |



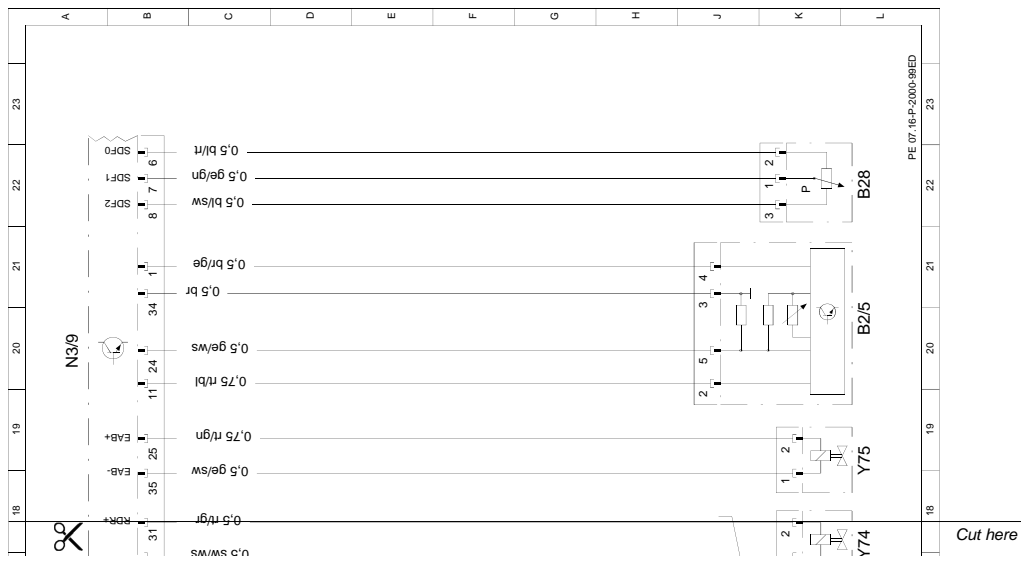

Wiring diagram of common rail diesel injection (CDI) / pe07.16-p-2000-99ed  
 ENGINE 613 in MODEL 210 except CODE (491) U.S. version Connectors 4 and 5 / Printed on: 06.01.2019 / Page 2/2

B. W210 E320 CDI wiring diagram for reference (OM613 engine)

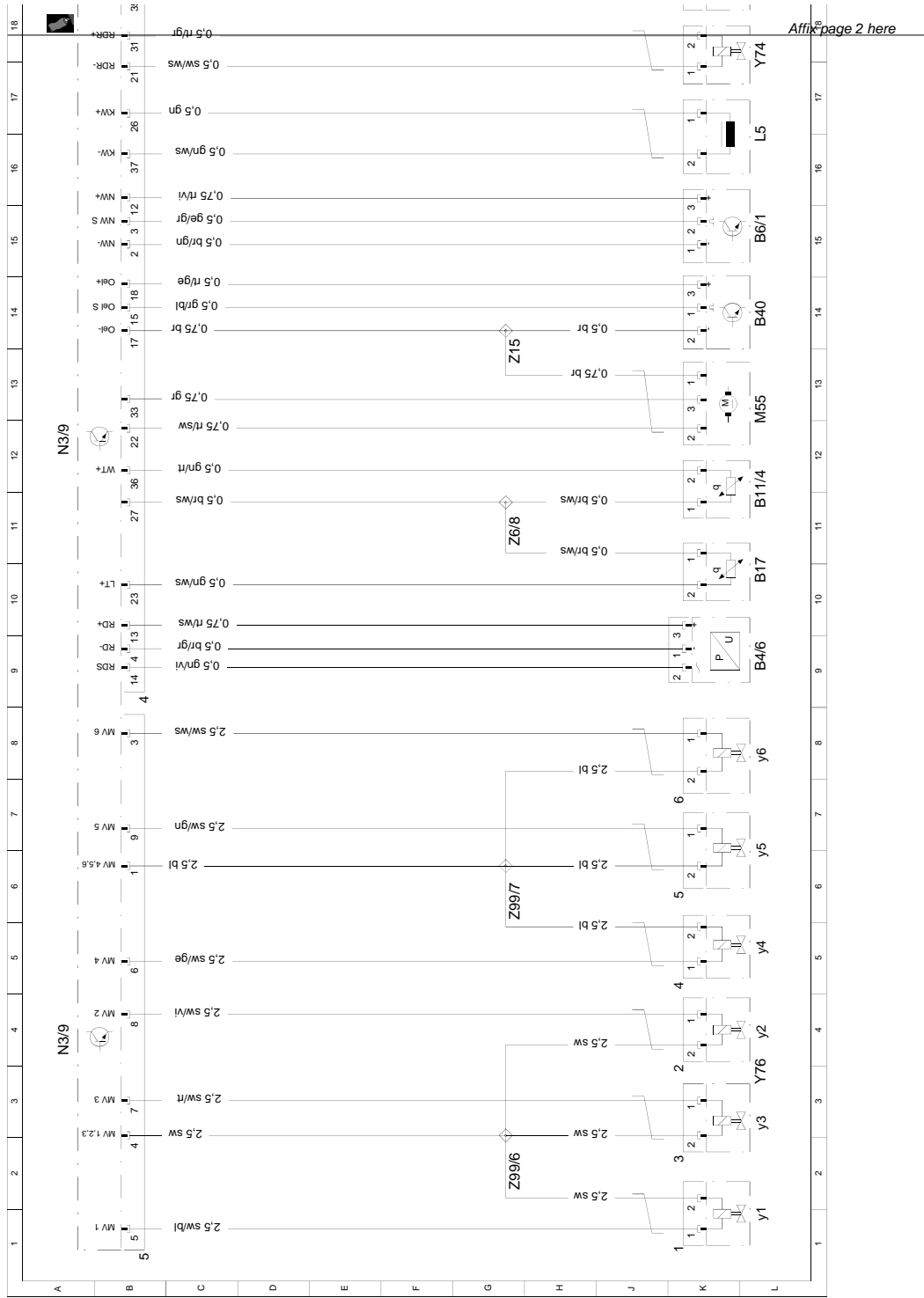

Affix page 2 here

Wiring diagram of common rail diesel injection (CDI) / pe07.16-p-2000-99ed  
ENGINE 613 in MODEL 210 except CODE (491) U.S. version Connectors 4 and 5 / Printed on: 06.01.2019 / Page 1/2

## B. W210 E320 CDI wiring diagram for reference (OM613 engine)

---

**Document number:** pe07.16-p-2000-99ec  
**Document title:** Wiring diagram of common rail diesel injection (CDI) control module

| <b>Code:</b> | <b>Designation:</b>                               | <b>Coordinates:</b> |
|--------------|---|---------------------|
| A1           | Instrument cluster                                | 56 L                |
| A1           | Instrument cluster                                | 58 L                |
| B37          | Accelerator pedal sensor                          | 37 L                |
| F1           | Fuse and relay box                                | 49 L                |
| F1f14        | Fuse 14   | 49 K                |
| G1           | Battery   | 16 L                |
| G2           | Generator   | 53 L                |
| K16          | Heater booster relay                              | 48 L                |
| K40/4        | Fuse and relay module (front passenger)           | 18 L                |
| K40/4        | Fuse and relay module (front passenger)           | 24 L                |
| K40/4        | Fuse and relay module (front passenger)           | 60 H                |
| K40/4f1      | Fuse, circuit 30z                                 | 19 L                |
| K40/4f2      | Fuse 2, diesel engine control module power supply | 24 L                |
| K40/4f3      | Fuse 1, diesel engine control module power supply | 23 L                |
| K40/4f5      | Fuse, ETC/ADS [EGS/ADS]                           | 25 L                |
| K40/4k1      | Polarity protection relay                         | 17 L                |
| K40/4k2      | Starter relay                                     | 20 L                |
| K40/4k3      | Diesel voltage supply relay                       | 22 L                |
| M1           | Starter   | 32 L                |
| M2/2         | Control module box blower motor                   | 30 L                |
| N14/2        | Preglow output                                    | 41 L                |
| N15/5        | Electronic selector lever module control module   | 14 L                |
| N3/9         | CDI control module                                | 12 A                |
| N3/9         | CDI control module                                | 20 A                |
| N3/9         | CDI control module                                | 27 A                |
| N3/9         | CDI control module                                | 36 A                |
| N3/9         | CDI control module                                | 44 A                |
| N3/9         | CDI control module                                | 52 A                |
| N3/9         | CDI control module                                | 59 A                |
| N33/2        | Heater booster control module                     | 45 L                |
| N33/2x1      | Heater booster control module connector           | 46 K                |
| N73          | DI control module                                 | 3 L                 |
| N73          | DI control module                                 | 9 L                 |
| R39/1        | Vent line heater element                          | 33 L                |
| R9           | Glow plugs  | 40 E                |
| S4/3         | Heater booster switch                             | 60 L                |
| S40/4        | CC with variable speed limiter switch             | 3 A                 |
| S40/4s1      | Resume from memory                                | 3 C                 |
| S40/4s2      | Decelerate and set                                | 3 C                 |

## B. W210 E320 CDI wiring diagram for reference (OM613 engine)

---

**Document number:** pe07.16-p-2000-99ec  
**Document title:** Wiring diagram of common rail diesel injection (CDI) control module

| <b>Code:</b> | <b>Designation:</b>                                 | <b>Coordinates:</b> |
|--------------|---|---------------------|
| S40/4s3      | Accelerate and set                                  | 3 B                 |
| S40/4s4      | Off   | 3 B                 |
| S40/4s5      | Control contact                                     | 3 B                 |
| S40/4s6      | Variable speed                                      | 4 C                 |
| U12          | Valid for left-hand steering                        | 27 D                |
| U12          | Valid for left-hand steering                        | 29 D                |
| U12          | Valid for left-hand steering                        | 31 D                |
| U13          | Valid for right-hand steering                       | 26 D                |
| U13          | Valid for right-hand steering                       | 28 D                |
| U13          | Valid for right-hand steering                       | 29 H                |
| U13          | Valid for right-hand steering                       | 30 D                |
| W1           | Main ground (behind instrument cluster)             | 9 H                 |
| W11/3        | Ground (engine - left side)                         | 33 H                |
| W16/3        | Ground (output ground-left wheel housing)           | 39 H                |
| W16/4        | Ground (output ground - right wheel housing)        | 21 E                |
| W16/5        | Electronics ground (left of component compartment)  | 26 E                |
| W16/5        | Electronics ground (left of component compartment)  | 28 E                |
| W16/5        | Electronics ground (left of component compartment)  | 30 E                |
| W16/6        | Electronics ground (right of component compartment) | 26 E                |
| W16/6        | Electronics ground (right of component compartment) | 28 E                |
| W16/6        | Electronics ground (right of component compartment) | 30 E                |
| X11/4        | Data link connector                                 | 20 E                |
| X11/4        | Data link connector                                 | 26 E                |
| X11/4        | Data link connector                                 | 39 E                |
| X12/3        | Terminal block (circuit 30)                         | 42 H                |
| X12/3        | Terminal block (circuit 30)                         | 51 L                |
| X12/3f1      | Generator prefuse                                   | 43 G                |
| X12/3f1      | Generator prefuse                                   | 51 K                |
| X22          | Engine compartment and engine connector             | 53 E                |
| X4           | Terminal block (circuit 30, left footwell)          | 8 G                 |
| X4           | Terminal block (circuit 30, left footwell)          | 31 H                |
| X4           | Terminal block (circuit 30, left footwell)          | 43 E                |
| X4/2         | Circuit 30 connector, heater booster, generator     | 50 E                |
| X4/3         | Circuit 30 connector, heater booster, battery       | 50 H                |
| X63/6        | CAN databus/15u connector                           | 5 G                 |
| Y31/4        | EGR [ARF]/pressure control flap vacuum transducer   | 34 L                |
| Y31/5        | Boost pressure control vacuum transducer            | 35 L                |
| Z26          | Circuit 61e connector sleeve                        | 60 E                |
| Z37/13       | CAN engine bus (low) connector sleeve               | 6 H                 |

**Document number:** pe07.16-p-2000-99ec  
**Document title:** Wiring diagram of common rail diesel injection (CDI) control module

| <b>Code:</b> | <b>Designation:</b>                    | <b>Coordinates:</b> |
|--------------|--|---------------------|
| Z37/14       | CAN engine bus (high) connector sleeve | 5 H                 |
| Z37/2        | CAN engine bus (low) connector sleeve  | 6 D                 |
| Z37/3        | CAN engine bus (high) connector sleeve | 5 D                 |
| Z7/24        | Circuit 87 connector sleeve            | 24 E                |
| Z7/30        | Circuit 30 (unfused) connector sleeve  | 8 H                 |
| Z9           | Connector sleeve 1                     | 17 E                |

B. W210 E320 CDI wiring diagram for reference (OM613 engine)

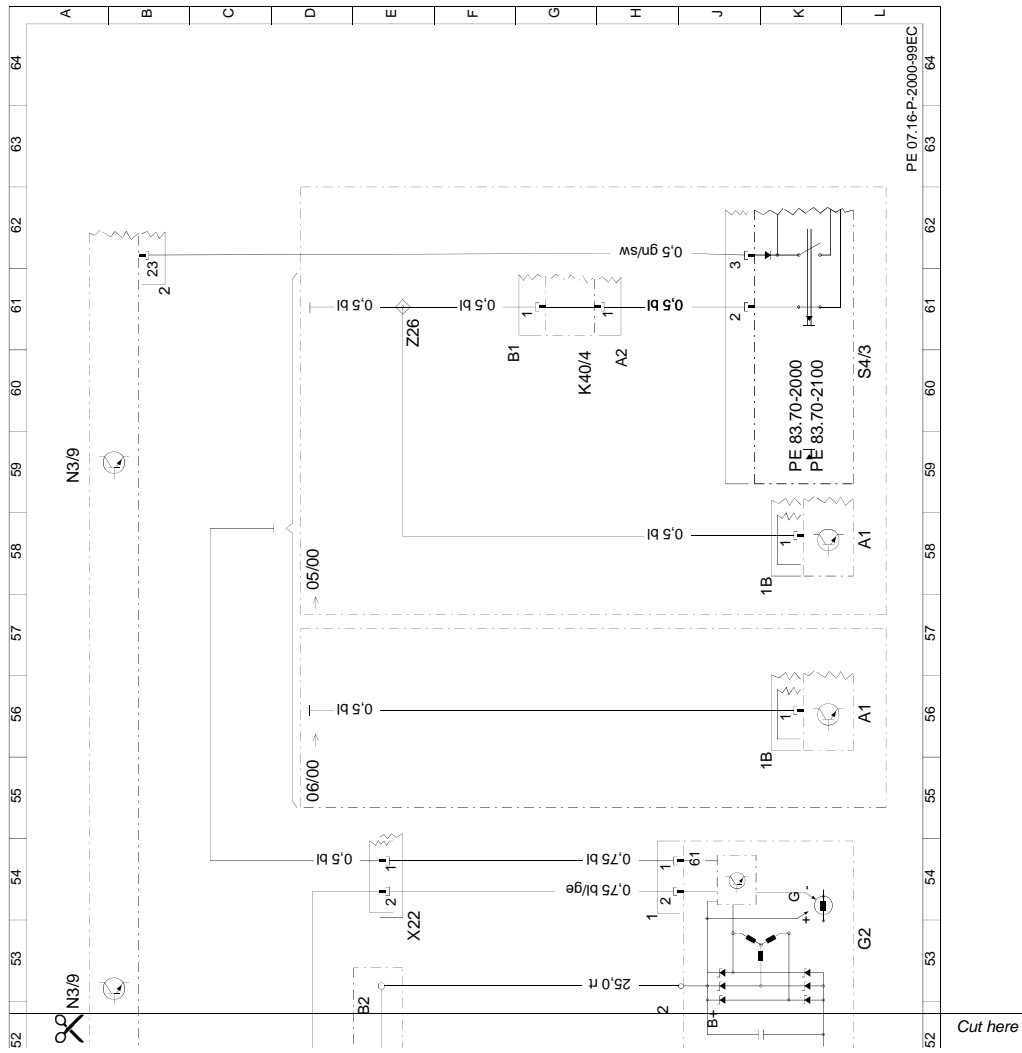

Wiring diagram of common rail diesel injection (CDI) control module / pe07.16-p-2000-99ec ENGINE 613 in MODEL 210 except CODE (491) U.S. version with CODE (440a) Cruise control plug 1 - 3, with electrical heater booster /



# B. W210 E320 CDI wiring diagram for reference (OM613 engine)

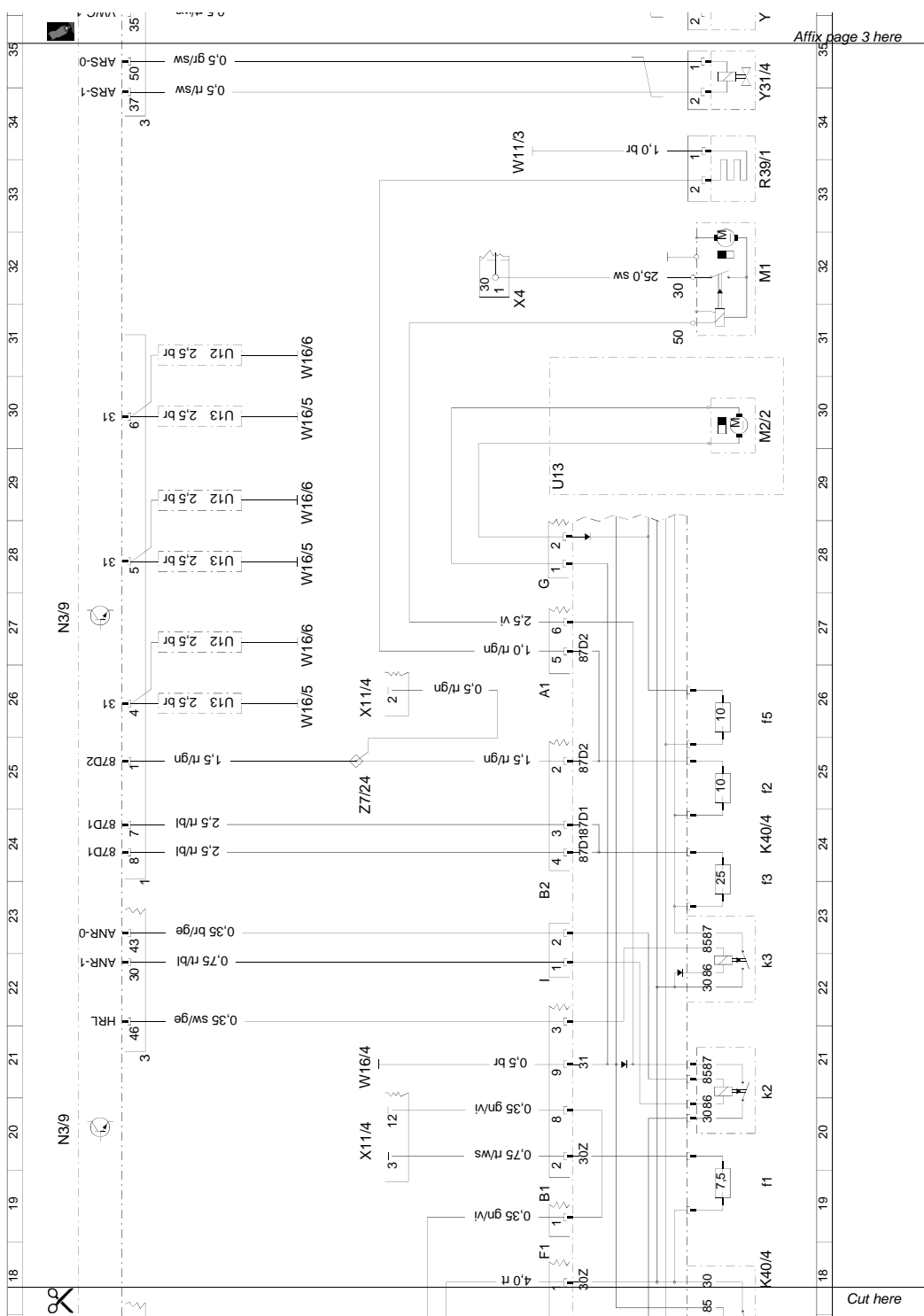

Wiring diagram of common rail diesel injection (CDI) control module / pe07.16-p-2000-99ec ENGINE 613 in MODEL 210 except CODE (491) U.S. version with CODE (440a) Cruise control plug 1 - 3, with electrical heater booster /



B. W210 E320 CDI wiring diagram for reference (OM613 engine)

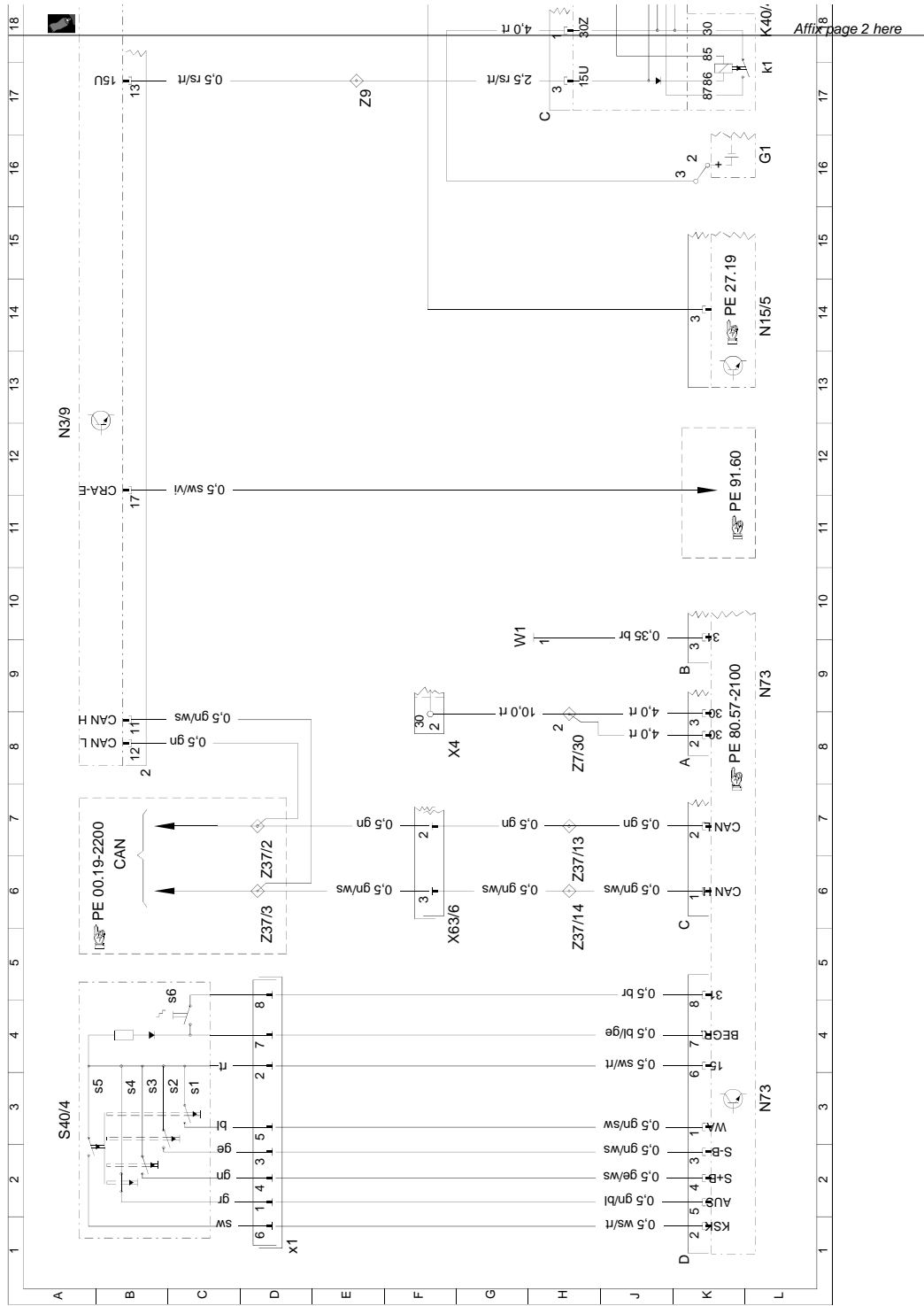

Wiring diagram of common rail diesel injection (CDI) control module / pe07.16-p-2000-99ec ENGINE 613 in MODEL 210 except CODE (491) U.S. version with CODE (440a) Cruise control plug 1 - 3, with electrical heater booster /

C. W210 E220 or E270 CDI wiring diagram for reference (OM611 or OM612 engine)

---

## C W210 E220 or E270 CDI wiring diagram for reference (OM611 or OM612 engine)

**Document number:** pe07.16-p-2000-99ea  
**Document title:** Wiring diagram of common rail diesel injection (CDI) control module

| <b>Code:</b> | <b>Designation:</b>                                | <b>Coordinates:</b> |
|--------------|--|---------------------|
| A1           | Instrument cluster                                 | 69 L                |
| A1           | Instrument cluster                                 | 72 L                |
| B17          | Intake air temperature sensor                      | 40 L                |
| B28          | Pressure sensor                                    | 41 L                |
| B37          | Accelerator pedal sensor                           | 45 L                |
| F1           | Fuse and relay box                                 | 56 L                |
| F1           | Fuse and relay box                                 | 63 L                |
| F1f14        | Fuse 14  | 63 K                |
| F1f20        | Maxi-fuse 20                                       | 56 K                |
| G1           | Battery  | 20 L                |
| G2           | Generator  | 67 L                |
| K16          | Heater booster relay                               | 61 L                |
| K40/2        | Driver-side fuse and relay module                  | 18 E                |
| K40/2        | Driver-side fuse and relay module                  | 52 E                |
| K40/4        | Fuse and relay module (front passenger)            | 22 L                |
| K40/4        | Fuse and relay module (front passenger)            | 28 L                |
| K40/4        | Fuse and relay module (front passenger)            | 73 H                |
| K40/4f1      | Fuse, circuit 30z                                  | 23 L                |
| K40/4f2      | Fuse 2, diesel engine control module power supply  | 29 L                |
| K40/4f3      | Fuse 1, diesel engine control module power supply  | 27 L                |
| K40/4f5      | Fuse, ETC/ADS [EGS/ADS]                            | 29 L                |
| K40/4k1      | Polarity protection relay                          | 21 L                |
| K40/4k2      | Starter relay                                      | 24 L                |
| K40/4k3      | Diesel voltage supply relay                        | 26 L                |
| M1           | Starter  | 37 L                |
| M2/2         | Control module box blower motor                    | 34 L                |
| M4/3         | Electric suction-type fan (engine / AAC )          | 55 L                |
| M4/3x1       | Electric suction-type fan (engine / AAC) connector | 54 K                |
| N14/2        | Preglow output                                     | 48 L                |
| N15/5        | Electronic selector lever module control module    | 15 L                |
| N19          | AAC pushbutton control module                      | 18 L                |
| N22          | AAC pushbutton control module                      | 19 L                |
| N3/9         | CDI control module                                 | 13 A                |
| N3/9         | CDI control module                                 | 20 A                |
| N3/9         | CDI control module                                 | 29 A                |
| N3/9         | CDI control module                                 | 36 A                |
| N3/9         | CDI control module                                 | 44 A                |
| N3/9         | CDI control module                                 | 52 A                |
| N3/9         | CDI control module                                 | 60 A                |

C. W210 E220 or E270 CDI wiring diagram for reference (OM611 or OM612 engine)

---

**Document number:** pe07.16-p-2000-99ea  
**Document title:** Wiring diagram of common rail diesel injection (CDI) control module

| <b>Code:</b> | <b>Designation:</b>   | <b>Coordinates:</b> |
|--------------|---|---------------------|
| N3/9         | CDI control module  | 69 A                |
| N3/9         | CDI control module  | 74 A                |
| N33/2        | Heater booster control module                                   | 58 L                |
| N33/2x1      | Heater booster control module connector                         | 59 K                |
| N73          | DI control module   | 3 L                 |
| N73          | DI control module   | 8 L                 |
| N76          | Engine and air conditioning electric suction fan control module | 53 L                |
| R39/1        | Vent line heater element  | 38 L                |
| R9           | Glow plugs  | 48 E                |
| S16/6        | Kickdown switch   | 11 L                |
| S4/3         | Heater booster switch   | 74 L                |
| S40/3        | Clutch pedal switch   | 13 L                |
| S40/4        | CC with variable speed limiter switch                           | 3 A                 |
| S40/4s1      | Resume from memory  | 3 C                 |
| S40/4s2      | Decelerate and set  | 3 C                 |
| S40/4s3      | Accelerate and set  | 3 B                 |
| S40/4s4      | Off   | 3 B                 |
| S40/4s5      | Control contact   | 3 B                 |
| S40/4s6      | Variable speed  | 4 C                 |
| S40/4x1      | Variable cruise control switch connector                        | 1 D                 |
| U12          | Valid for left-hand steering                                    | 12 J                |
| U12          | Valid for left-hand steering                                    | 12 J                |
| U12          | Valid for left-hand steering                                    | 31 D                |
| U12          | Valid for left-hand steering                                    | 37 D                |
| U12          | Valid for left-hand steering                                    | 39 D                |
| U13          | Valid for right-hand steering                                   | 11 J                |
| U13          | Valid for right-hand steering                                   | 13 J                |
| U13          | Valid for right-hand steering                                   | 30 D                |
| U13          | Valid for right-hand steering                                   | 34 H                |
| U13          | Valid for right-hand steering                                   | 36 D                |
| U13          | Valid for right-hand steering                                   | 38 D                |
| U199         | Valid for engine 612  | 50 H                |
| U24          | Valid for MT [MG]   | 10 F                |
| U25          | Valid for automatic transmission                                | 14 F                |
| U29          | Valid for outside temperature indicator                         | 19 H                |
| U87          | Valid for AAC [KLA]   | 18 H                |
| W1           | Main ground (behind instrument cluster)                         | 9 H                 |
| W11/3        | Ground (engine - left side)                                     | 39 H                |
| W16/3        | Ground (output ground-left wheel housing)                       | 47 H                |

C. W210 E220 or E270 CDI wiring diagram for reference (OM611 or OM612 engine)

---

**Document number:** pe07.16-p-2000-99ea  
**Document title:** Wiring diagram of common rail diesel injection (CDI) control module

| <b>Code:</b> | <b>Designation:</b>                                 | <b>Coordinates:</b> |
|--------------|---|---------------------|
| W16/3        | Ground (output ground-left wheel housing)           | 52 H                |
| W16/4        | Ground (output ground - right wheel housing)        | 25 E                |
| W16/5        | Electronics ground (left of component compartment)  | 30 E                |
| W16/5        | Electronics ground (left of component compartment)  | 36 E                |
| W16/5        | Electronics ground (left of component compartment)  | 38 E                |
| W16/6        | Electronics ground (right of component compartment) | 31 E                |
| W16/6        | Electronics ground (right of component compartment) | 37 E                |
| W16/6        | Electronics ground (right of component compartment) | 39 E                |
| W18          | Ground (left front seat crossmember)                | 12 H                |
| W19          | Ground (right front seat crossmember)               | 13 H                |
| X11/4        | Data link connector                                 | 24 E                |
| X11/4        | Data link connector                                 | 30 E                |
| X11/4        | Data link connector                                 | 47 E                |
| X12/3        | Terminal block (circuit 30)                         | 50 H                |
| X12/3        | Terminal block (circuit 30)                         | 64 L                |
| X12/3f1      | Generator prefuse                                   | 51 G                |
| X12/3f1      | Generator prefuse                                   | 64 K                |
| X22          | Engine compartment and engine connector             | 67 E                |
| X4           | Terminal block (circuit 30, left footwell)          | 8 G                 |
| X4           | Terminal block (circuit 30, left footwell)          | 36 H                |
| X4           | Terminal block (circuit 30, left footwell)          | 51 E                |
| X4/2         | Circuit 30 connector, heater booster, generator     | 64 E                |
| X4/3         | Circuit 30 connector, heater booster, battery       | 63 H                |
| X63/6        | CAN databus/15u connector                           | 5 G                 |
| Y31/4        | EGR [ARF]/pressure control flap vacuum transducer   | 42 L                |
| Y31/5        | Boost pressure control vacuum transducer            | 43 L                |
| Z26          | Circuit 61e connector sleeve                        | 74 E                |
| Z37/13       | CAN engine bus (low) connector sleeve               | 6 H                 |
| Z37/14       | CAN engine bus (high) connector sleeve              | 5 H                 |
| Z37/2        | CAN engine bus (low) connector sleeve               | 6 D                 |
| Z37/3        | CAN engine bus (high) connector sleeve              | 5 D                 |
| Z7/24        | Circuit 87 connector sleeve                         | 29 E                |
| Z7/30        | Circuit 30 (unfused) connector sleeve               | 7 H                 |
| Z9           | Connector sleeve 1                                  | 9 E                 |
| Z9           | Connector sleeve 1                                  | 21 E                |

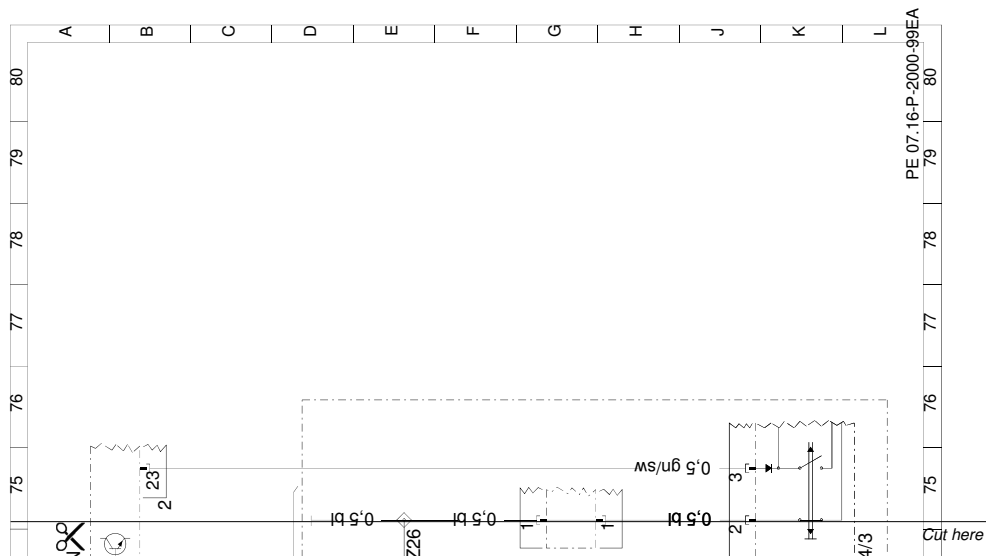

Wiring diagram of common rail diesel injection (CDI) control module / pe07.16-p-2000-99ea ENGINE 611 as of 1.6.99, 612 in MODEL 210 with CODE (440a) Cruise control connectors 1 - 3, with electric heater booster / Printed on: 15.12.20

C. W210 E220 or E270 CDI wiring diagram for reference (OM611 or OM612 engine)

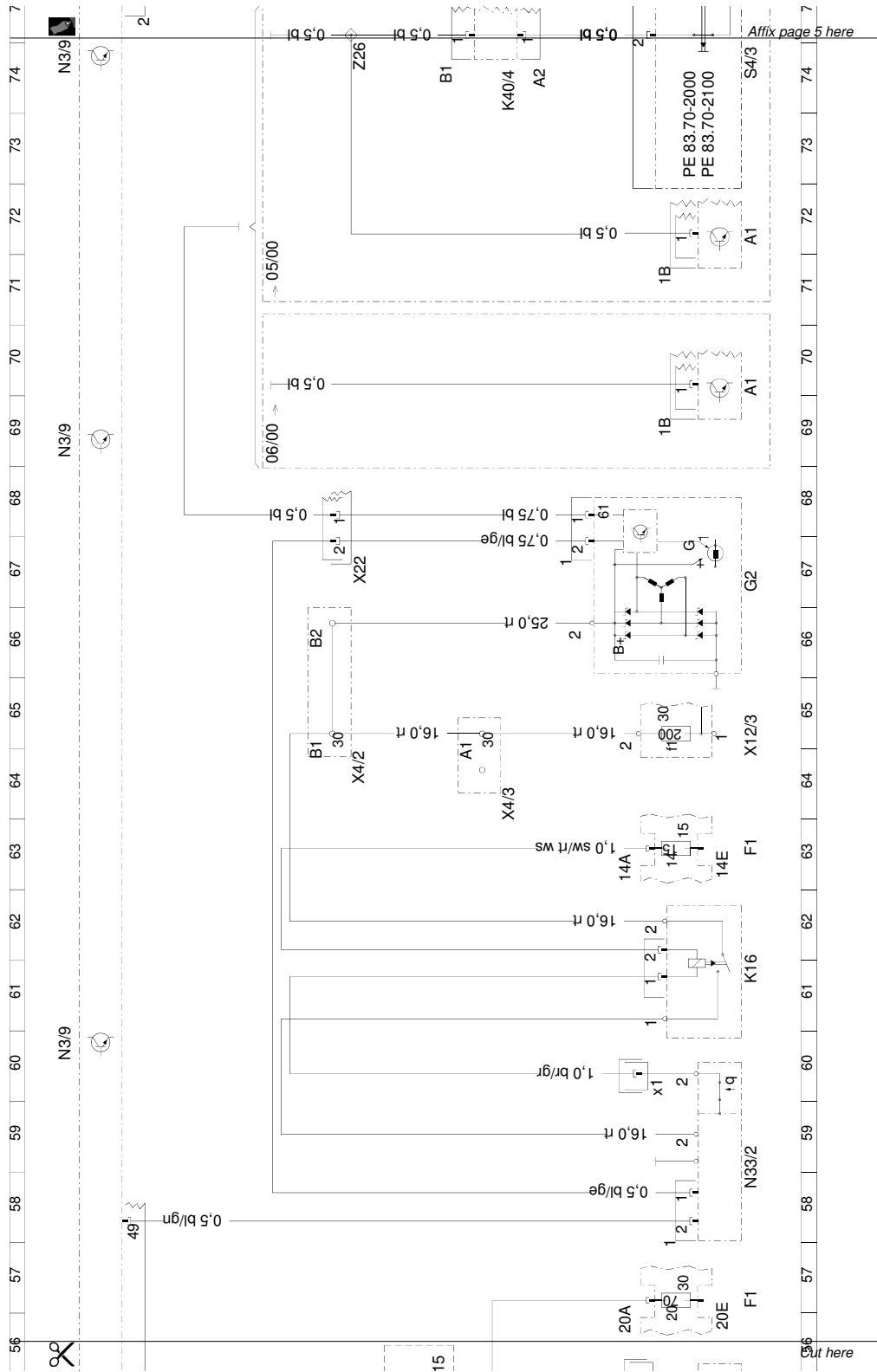

Wiring diagram of common rail diesel injection (CDI) control module / pe07.16-p-2000-99ea ENGINE 611 as of 1.6.99, 612 in MODEL 210 with CODE (440a) Cruise control connectors 1 - 3, with electric heater booster / Printed on: 15.12.21

C. W210 E220 or E270 CDI wiring diagram for reference (OM611 or OM612 engine)

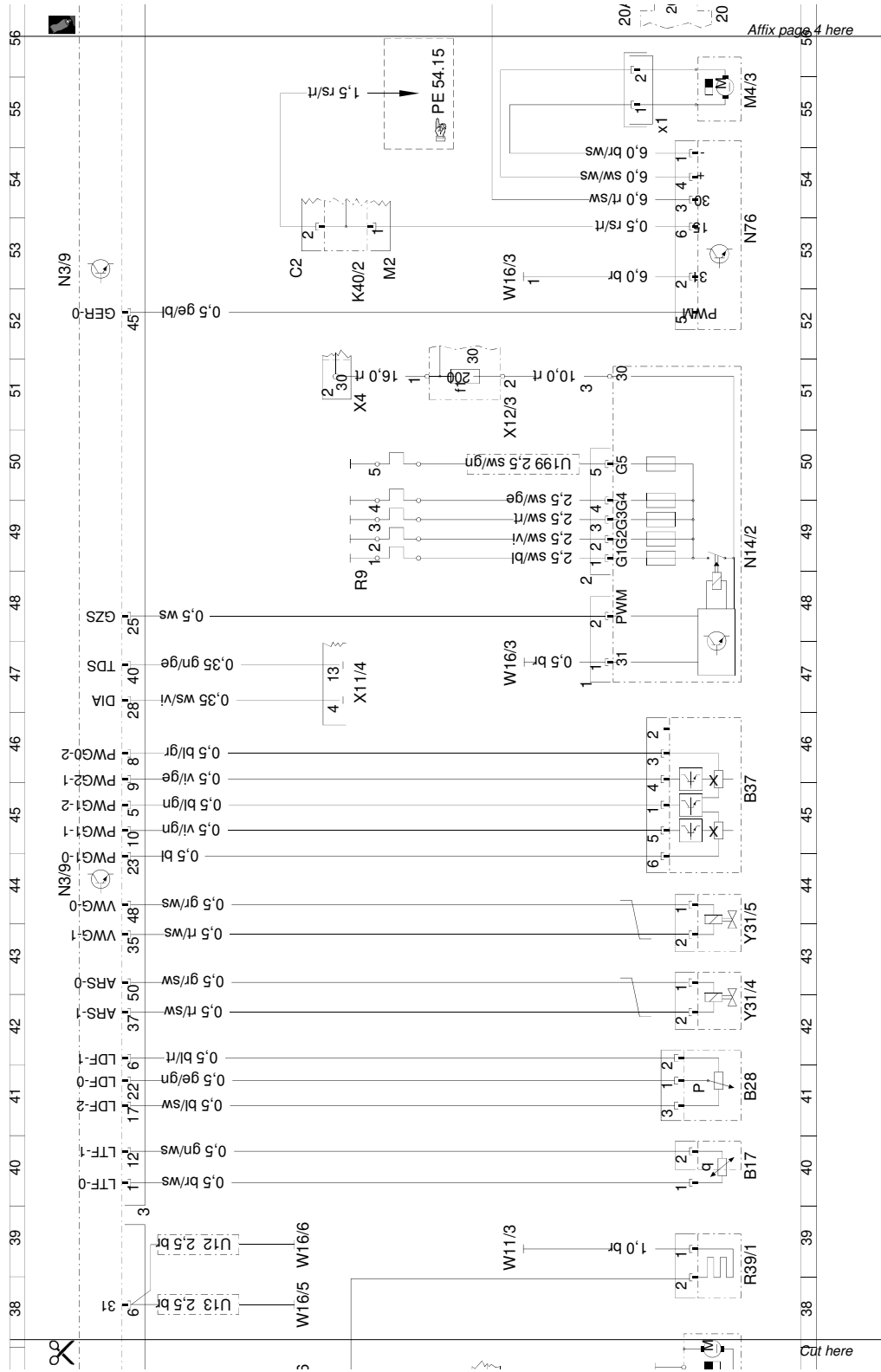

Wiring diagram of common rail diesel injection (CDI) control module / pe07.16-p-2000-99ea ENGINE 611 as of 1.6.99, 612 in MODEL 210 with CODE (440a) Cruise control connectors 1 - 3, with electric heater booster / Printed on: 15.12.21



C. W210 E220 or E270 CDI wiring diagram for reference (OM611 or OM612 engine)

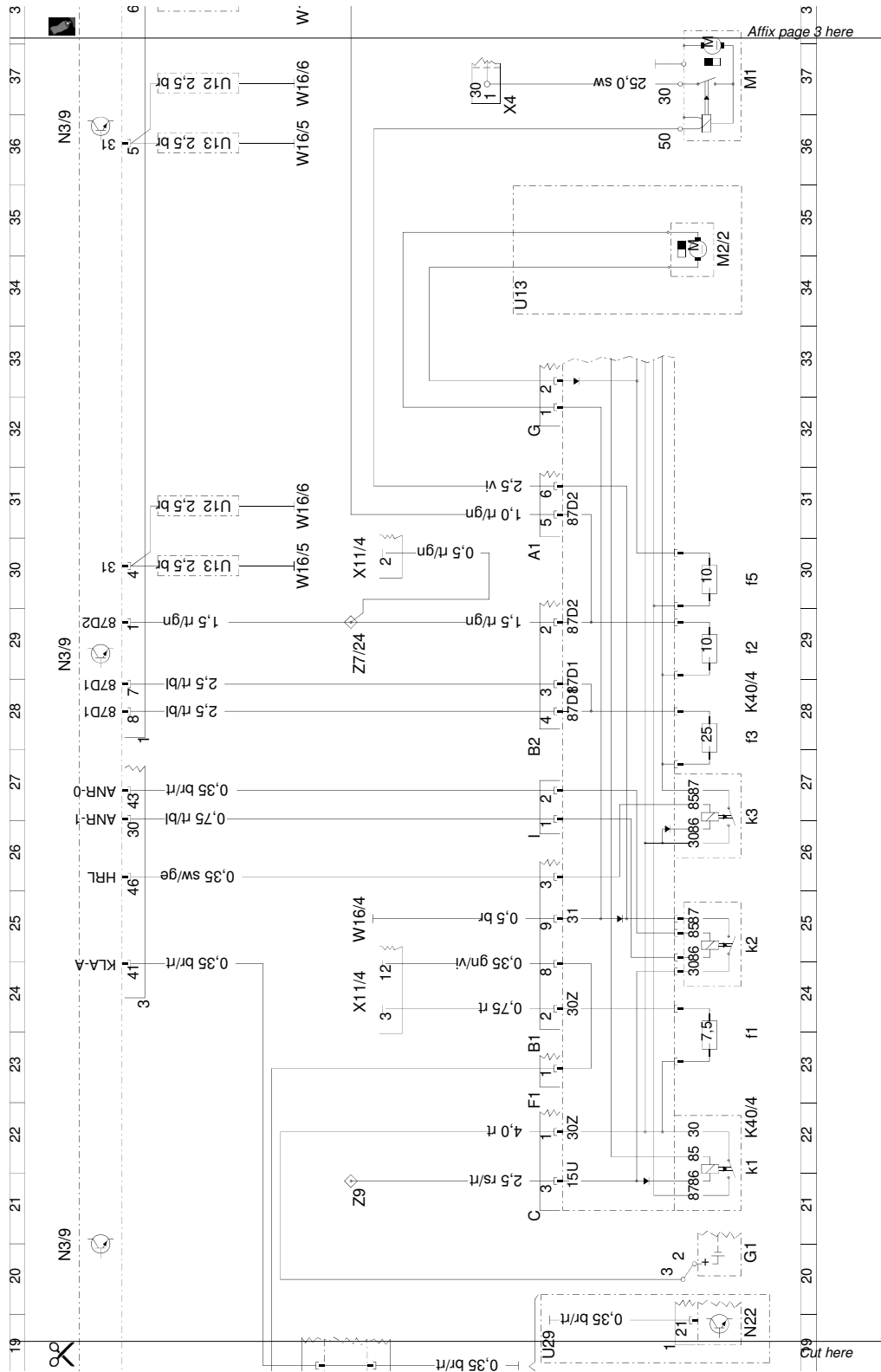

Wiring diagram of common rail diesel injection (CDI) control module / pe07.16-p-2000-99ea ENGINE 611 as of 1.6.99, 612 in MODEL 210 with CODE (440a) Cruise control connectors 1 - 3, with electric heater booster / Printed on: 15.12.21

C. W210 E220 or E270 CDI wiring diagram for reference (OM611 or OM612 engine)

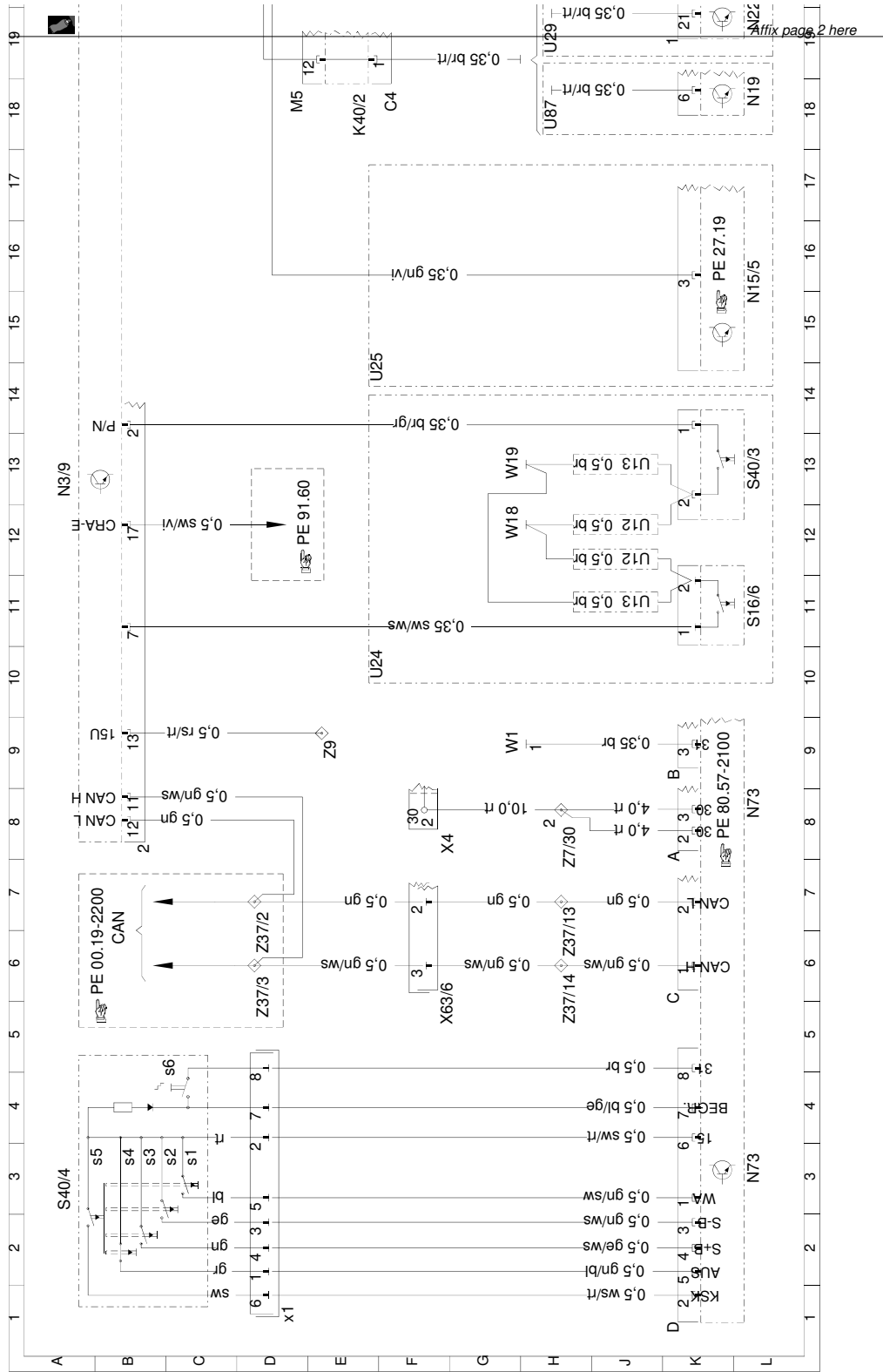

Affix page 2 here

Wiring diagram of common rail diesel injection (CDI) control module / pe07.16-p-2000-99ea ENGINE 611 as of 1.6.99, 612 in MODEL 210 with CODE (440a) Cruise control connectors 1 - 3, with electric heater booster / Printed on: 15.12.21

C. W210 E220 or E270 CDI wiring diagram for reference (OM611 or OM612 engine)

---

**Document number:** pe07.16-p-2000-99eb  
**Document title:** Wiring diagram of common rail diesel injection (CDI) control module

| <b>Code:</b> | <b>Designation:</b>                             | <b>Coordinates:</b> |
|--------------|---|---------------------|
| B11/4        | Coolant temperature sensor                      | 15 L                |
| B2/5         | Hot film MAF sensor                             | 24 L                |
| B4/6         | Rail pressure sensor                            | 14 L                |
| B40          | Oil sensor (oil level, temperature and quality) | 18 L                |
| B6/1         | Camshaft Hall sensor                            | 19 L                |
| L5           | Crankshaft position sensor                      | 20 L                |
| M55          | Inlet port shutoff motor                        | 16 L                |
| N3/9         | CDI control module                              | 4 A                 |
| N3/9         | CDI control module                              | 12 A                |
| N3/9         | CDI control module                              | 19 A                |
| U198         | Valid for engine 611                            | 1 A                 |
| U199         | Valid for engine 612                            | 7 A                 |
| Y74          | Pressure regulator valve                        | 21 L                |
| Y75          | Electrical switch-off valve                     | 22 L                |
| Y76          | Injectors (LH-SFI, HFM-SFI, PEC [LH, HFM, PMS]) | 4 L                 |
| Y76          | Injectors (LH-SFI, HFM-SFI, PEC [LH, HFM, PMS]) | 9 L                 |
| Y76y1        | Injector cylinder 1                             | 2 L                 |
| Y76y1        | Injector cylinder 1                             | 7 L                 |
| Y76y2        | Injector cylinder 2                             | 4 L                 |
| Y76y2        | Injector cylinder 2                             | 11 L                |
| Y76y3        | Injector cylinder 3                             | 5 L                 |
| Y76y3        | Injector cylinder 3                             | 9 L                 |
| Y76y4        | Injector cylinder 4                             | 3 L                 |
| Y76y4        | Injector cylinder 4                             | 10 L                |
| Y76y5        | Fuel injector cylinder 5                        | 12 L                |
| Z15          | Connector sleeve 7                              | 17 H                |
| Z99/6        | Common rail solenoid valve 1 connector sleeve   | 2 H                 |
| Z99/6        | Common rail solenoid valve 1 connector sleeve   | 8 H                 |
| Z99/7        | Common rail solenoid valve 2 connector sleeve   | 5 H                 |
| Z99/7        | Common rail solenoid valve 2 connector sleeve   | 12 H                |

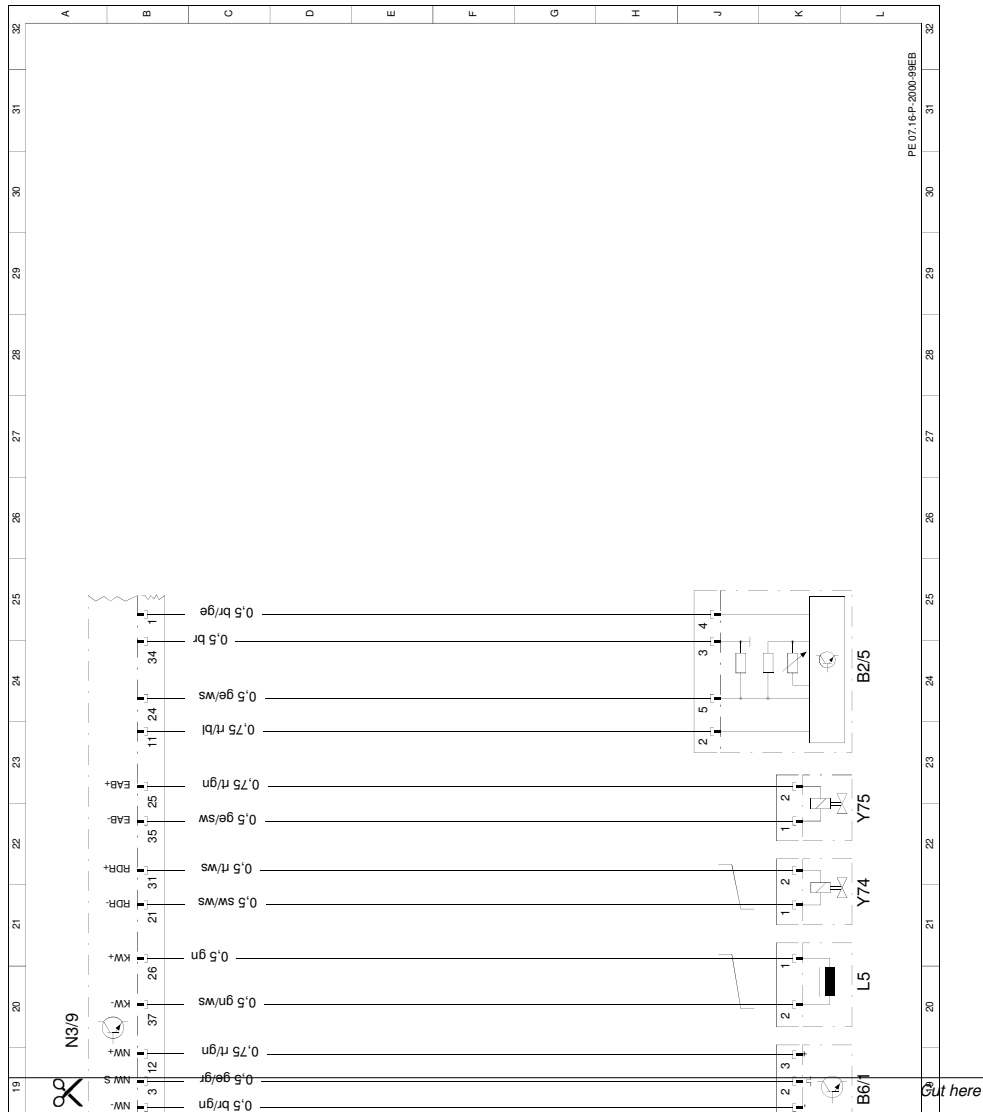

Wiring diagram of common rail diesel injection (CDI) control module / pe07.16-p-2000-99eb ENGINE 611 as of 1.6.99, 612 in MODEL 210 connectors 4 and 5 / Printed on: 15.12.2019 / Page 2/2

C. W210 E220 or E270 CDI wiring diagram for reference (OM611 or OM612 engine)

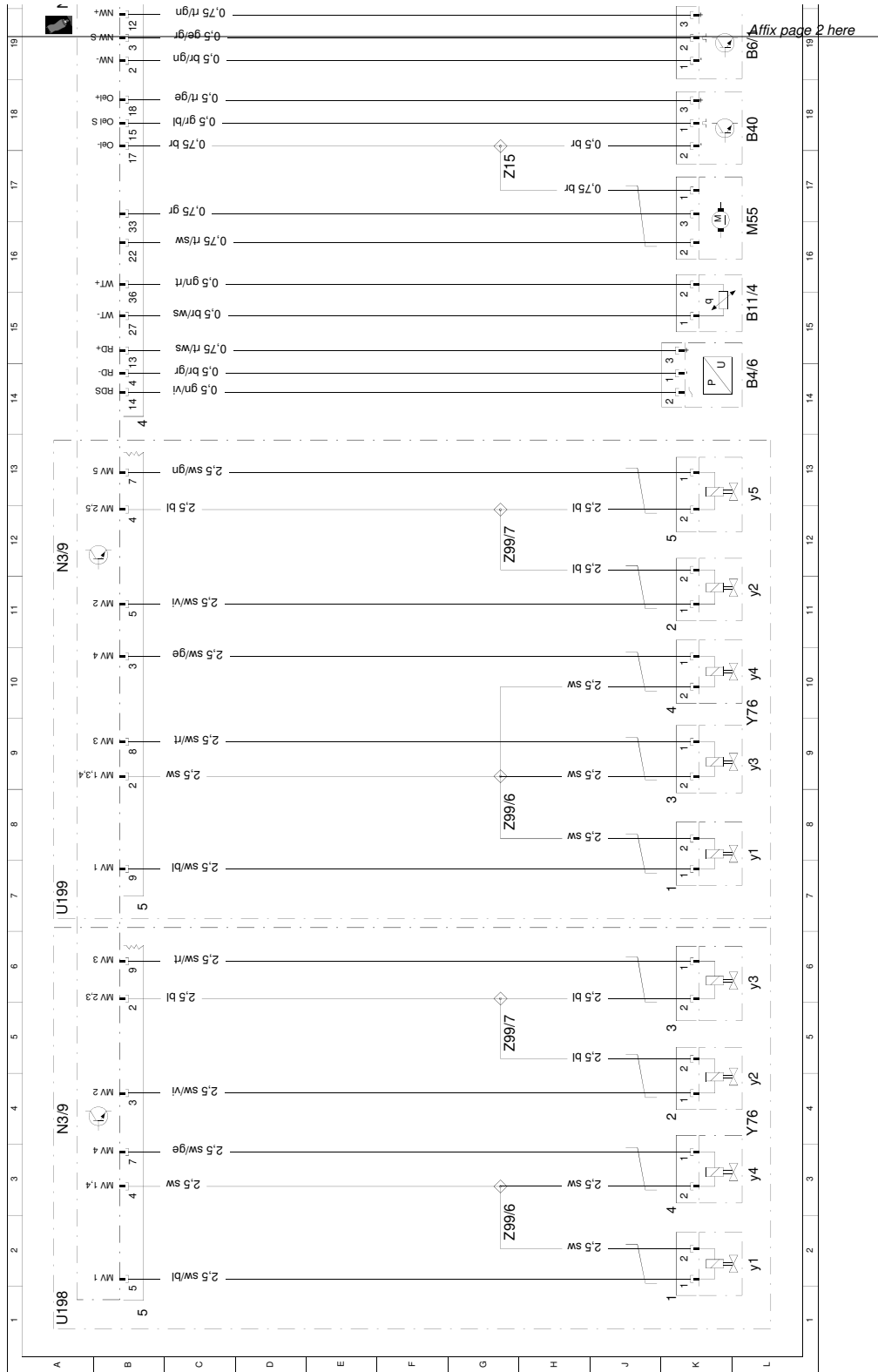

Wiring diagram of common rail diesel injection (CDI) control module / pe07.16-p-2000-99eb  
ENGINE 611 as of 1.6.99, 612 in MODEL 210 connectors 4 and 5 / Printed on: 15.12.2019 / Page 1/2

# D W163 ML270 CDI wiring diagram for reference (OM612 engine)

**Document number:** pe07.16-p-2000-99gh  
**Document title:** Wiring diagram of common rail diesel injection (CDI) control module

| <b>Code:</b> | <b>Designation:</b>  | <b>Coordinates:</b> |
|--------------|--|---------------------|
| B11/4        | Coolant temperature sensor                                 | 40 L                |
| B17          | IAT sensor   | 33 L                |
| B2/5         | Hot film MAF sensor  | 35 L                |
| B28          | Pressure sensor  | 30 L                |
| B4/6         | Rail pressure sensor                                       | 48 L                |
| B40          | Oil sensor (oil level, temperature and quality)            | 45 L                |
| B6/1         | Camshaft Hall sensor                                       | 37 L                |
| F1           | Fuse and relay module                                      | 2 C                 |
| F1           | Fuse and relay module                                      | 27 C                |
| F1f14        | Fuse 14  | 11 C                |
| F1k11        | Circuit 15 delayed relay                                   | 9 D                 |
| F1k12        | Circuit 15 relay   | 5 D                 |
| F24/8        | Circuit 15 auxiliary fuse                                  | 11 L                |
| G1           | Battery  | 4 H                 |
| L5           | Crankshaft position sensor                                 | 42 L                |
| M55          | Inlet port shutoff motor                                   | 46 L                |
| N10          | All-activity module  | 4 A                 |
| N10          | All-activity module  | 10 A                |
| N14/2        | Preglow output   | 24 L                |
| N3/9         | CDI control module   | 17 A                |
| N3/9         | CDI control module   | 27 A                |
| N3/9         | CDI control module   | 37 A                |
| N3/9         | CDI control module   | 47 A                |
| N3/9         | CDI control module   | 56 A                |
| R39/1        | Vent line heater element                                   | 17 L                |
| R9           | Glow plugs   | 24 C                |
| R9           | Glow plugs   | 24 C                |
| R9           | Glow plugs   | 25 C                |
| R9           | Glow plugs   | 25 C                |
| R9           | Glow plugs   | 26 C                |
| S2           | Starter switch   | 3 L                 |
| W11/3        | Ground (engine - left side)                                | 16 H                |
| W16/4        | Ground (output ground - component compartment - right)     | 6 L                 |
| W16/5        | Electronics ground (left of component compartment)         | 18 F                |
| W2           | Ground (at right headlamp unit)                            | 23 C                |
| X12/3        | Terminal block (circuit 30, 15, 31, 3-pin)                 | 4 E                 |
| X12/3        | Terminal block (circuit 30, 15, 31, 3-pin)                 | 27 E                |
| X18/31       | Left engine compartment/right engine compartment connector | 29 G                |
| X22          | Engine compartment and engine connector                    | 17 G                |

**Document number:** pe07.16-p-2000-99gh  
**Document title:** Wiring diagram of common rail diesel injection (CDI) control module

| <b>Code:</b> | <b>Designation:</b>   | <b>Coordinates:</b> |
|--------------|---|---------------------|
| X4/37        | Circuit 30 terminal block                                       | 4 F                 |
| Y31/5        | Boost pressure control vacuum transducer                        | 28 L                |
| Y74          | Pressure regulator valve  | 43 L                |
| Y75          | Electrical switch-off valve                                     | 39 L                |
| Y76y1        | Fuel injector (1st cylinder)                                    | 50 L                |
| Y76y2        | Fuel injector (2nd cylinder)                                    | 54 L                |
| Y76y3        | Fuel injector (3rd cylinder)                                    | 53 L                |
| Y76y4        | Fuel injector (4th cylinder)                                    | 51 L                |
| Y76y5        | UNBEKANNT   | 56 L                |
| Z18          | Connector sleeve 10   | 45 F                |
| Z50/5        | Cockpit connector sleeve (circuit 30)                           | 2 G                 |
| Z50/6        | Cockpit connector sleeve (circuit 15C)                          | 1 H                 |
| Z50/9        | Cockpit connector sleeve II (circuit 15)                        | 1 G                 |
| Z57/11       | Right engine compartment, circuit 15 connector sleeve           | 15 F                |
| Z57/7        | Connector sleeve in right of engine compartment, circuit 31 (3) | 18 D                |
| Z57/7        | Connector sleeve in right of engine compartment, circuit 31 (3) | 23 F                |
| Z99/6        | Common rail solenoid valve 1 connector sleeve                   | 50 G                |
| Z99/7        | Common rail solenoid valve 2 connector sleeve                   | 54 G                |

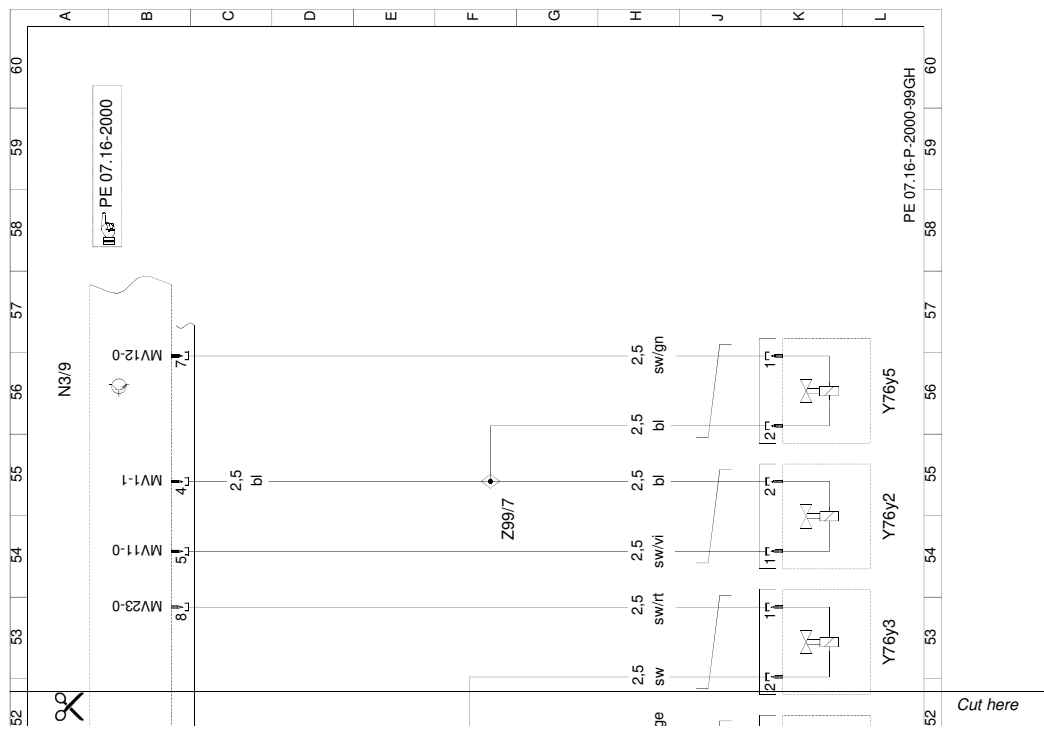

Wiring diagram of common rail diesel injection (CDI) control module / pe07.16-p-2000-99gh  
ENGINE 612 in MODEL 163 up to 31.8.01 Engine block wiring harnesses / Printed on: 07.12.2019 / Page 4/4



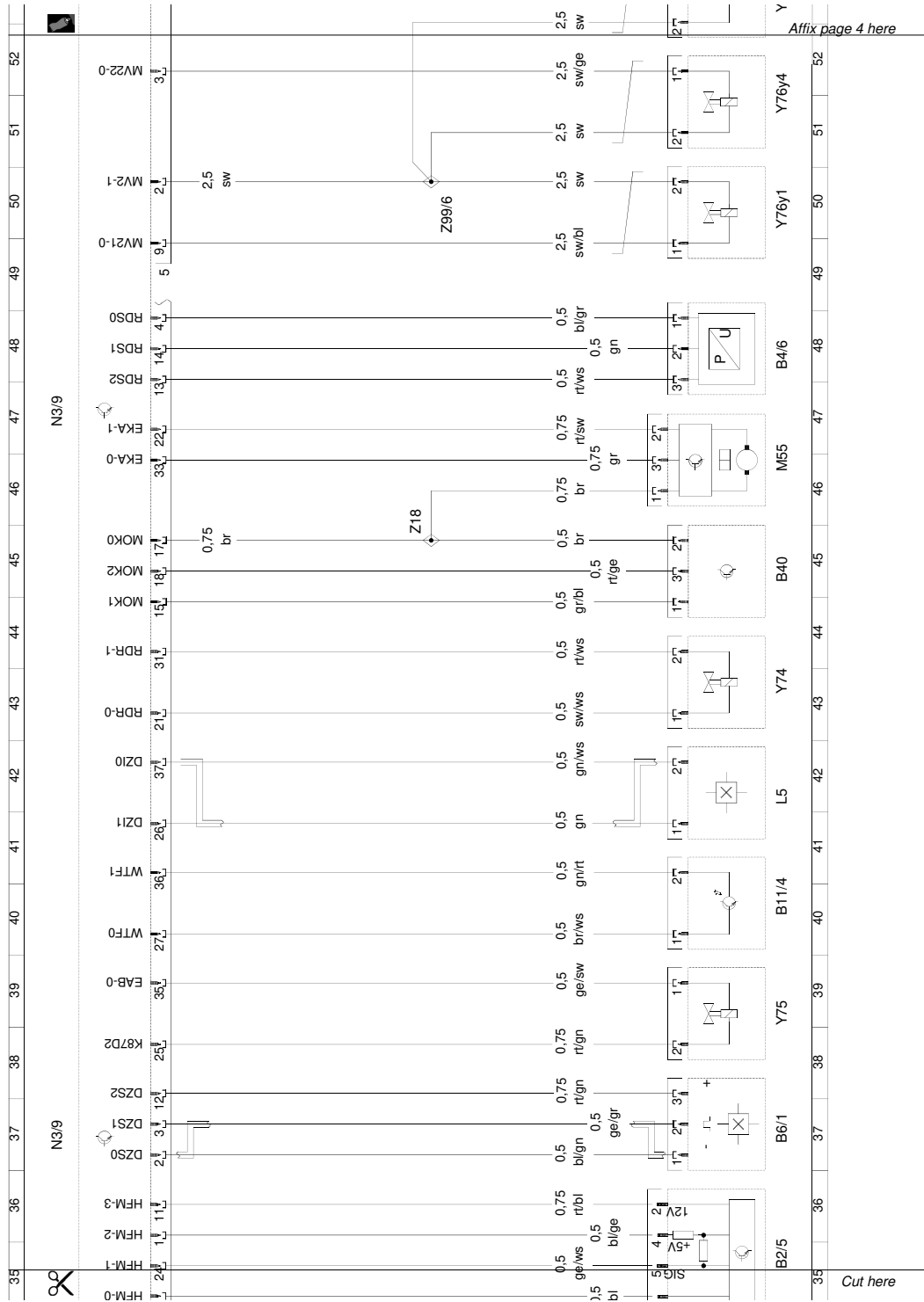

Wiring diagram of common rail diesel injection (CDI) control module / pe07.16-p-2000-99gh  
 ENGINE 612 in MODEL 163 up to 31.8.01 Engine block wiring harnesses / Printed on: 07.12.2019 / Page 3/4

D. W163 ML270 CDI wiring diagram for reference (OM612 engine)

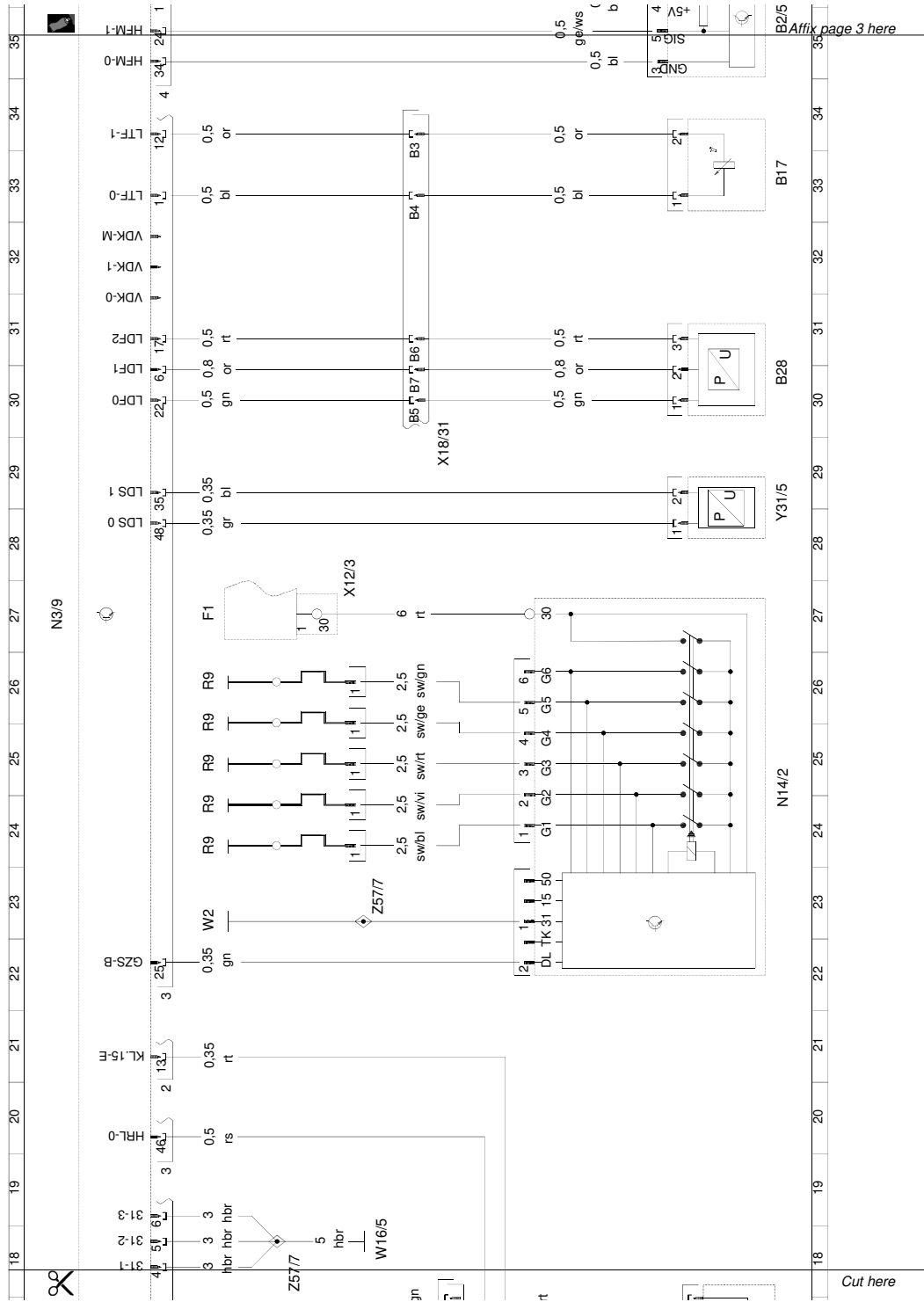

Wiring diagram of common rail diesel injection (CDI) control module / pe07.16-p-2000-99gh  
 ENGINE 612 in MODEL 163 up to 31.8.01 Engine block wiring harnesses / Printed on: 07.12.2019 / Page 2/4

D. W163 ML270 CDI wiring diagram for reference (OM612 engine)

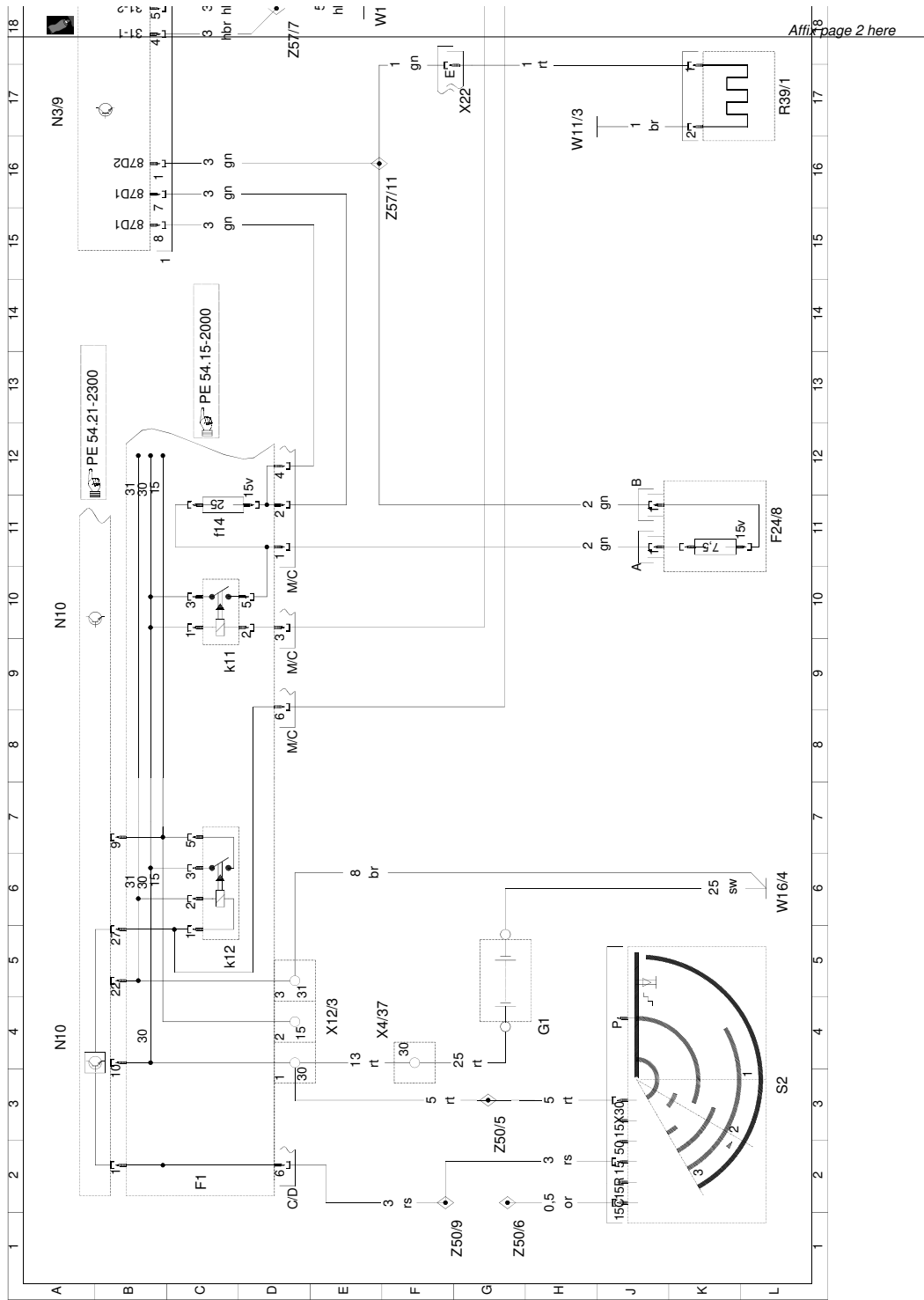

Wiring diagram of common rail diesel injection (CDI) control module / pe07.16-p-2000-99gh  
ENGINE 612 in MODEL 163 up to 31.8.01 Engine block wiring harnesses / Printed on: 07.12.2019 / Page 1/4

**Document number:** pe07.16-p-2000-99go  
**Document title:** Wiring diagram of common rail diesel injection (CDI) control unit

| <b>Code:</b> | <b>Designation:</b>  | <b>Coordinates:</b> |
|--------------|--|---------------------|
| B37          | Accelerator pedal sensor                                   | 43 L                |
| F1           | Fuse and relay module                                      | 1 C                 |
| F1           | Fuse and relay module                                      | 26 L                |
| F1f14        | Fuse 14  | 12 C                |
| F1k11        | Diesel voltage supply relay                                | 10 C                |
| F1k12        | Circuit 15 relay   | 5 C                 |
| F24/7        | Circuit 30 auxiliary fuse, suction fan                     | 40 G                |
| F24/8        | Circuit 15 auxiliary fuse                                  | 12 L                |
| G1           | Battery  | 4 H                 |
| G1           | Battery  | 39 F                |
| M4/7         | Electric suction fan engine and AC with integrated control | 38 L                |
| N10          | All-activity module  | 4 A                 |
| N10          | All-activity module  | 11 A                |
| N10/1        | Extended Activity module (EAM)                             | 50 A                |
| N2/7         | Restraint systems control module                           | 31 L                |
| N3/9         | CDI control module   | 18 A                |
| N3/9         | CDI control module   | 28 A                |
| N3/9         | CDI control module   | 39 A                |
| S16/6        | Kickdown switch  | 27 L                |
| S2           | Starter switch   | 3 L                 |
| S40/3        | Clutch pedal switch  | 7 L                 |
| S40/4        | CC with variable speed limiter switch                      | 50 L                |
| S40/4s1      | Resume from memory   | 47 J                |
| S40/4s2      | Decelerate and set   | 51 J                |
| S40/4s3      | Accelerate and set   | 50 J                |
| S40/4s4      | Off  | 47 J                |
| S40/4s5      | Control contact  | 50 J                |
| S40/4s6      | Variable speed   | 51 K                |
| S40/4v1      | Yellow LED, variable speed limiter                         | 51 K                |
| U24          | Valid for MT [MG]  | 6 E                 |
| W16/4        | Ground (output ground - component compartment - right)     | 5 L                 |
| W16/4        | Ground (output ground - component compartment - right)     | 40 C                |
| W16/5        | Electronics ground (left of component compartment)         | 19 F                |
| W2           | Ground (at right headlamp unit)                            | 39 C                |
| W29/2        | Ground (right A-pillar)                                    | 7 F                 |
| X12/12       | Circuit 30 terminal block at relay module 1                | 2 E                 |
| X12/13       | Circuit 15 terminal block at relay module 1                | 4 E                 |
| X12/14       | Circuit 31 terminal block at relay module 1                | 5 E                 |
| X25/2        | Engine compartment/interior compartment connector          | 25 G                |

**Document number:** pe07.16-p-2000-99go  
**Document title:** Wiring diagram of common rail diesel injection (CDI) control unit

| <b>Code:</b> | <b>Designation:</b>                                       | <b>Coordinates:</b> |
|--------------|---|---------------------|
| X26          | Engine compartment/cockpit connector                      | 22 F                |
| X4/37        | Terminal block (circuit 30)                               | 4 F                 |
| Z37/2        | CAN engine bus (low) connector sleeve                     | 32 D                |
| Z37/3        | CAN engine bus (high) connector sleeve                    | 32 D                |
| Z50/11       | CAN-L cockpit connector sleeve                            | 53 D                |
| Z50/12       | CAN-H cockpit connector sleeve                            | 52 D                |
| Z50/3        | Cockpit connector sleeve (circuit 31, I left)             | 51 F                |
| Z50/4        | Cockpit connector sleeve (circuit 31, II right)           | 6 H                 |
| Z50/5        | Cockpit circuit 30 connector sleeve                       | 2 G                 |
| Z50/6        | Cockpit connector sleeve (circuit 15C)                    | 1 H                 |
| Z50/9        | Cockpit connector sleeve (circuit 15 II)                  | 1 F                 |
| Z51/14       | Interior connector sleeve, analog crash signal            | 30 J                |
| Z51/3        | Interior connector sleeve (CAN-High 2)                    | 33 J                |
| Z51/4        | Interior connector sleeve (CAN-Low 2)                     | 32 J                |
| Z51/8        | Interior connector sleeve II (circuit 31, right front)    | 27 H                |
| Z57/11       | Right engine compartment, circuit 15 connector sleeve     | 17 F                |
| Z57/7        | Right engine compartment connector sleeve, circuit 31 (3) | 18 E                |

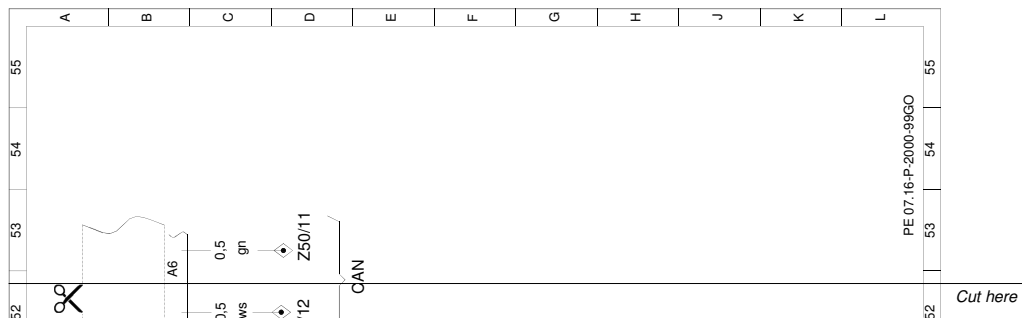

Wiring diagram of common rail diesel injection (CDI) control unit / pe07.16-p-2000-99go  
ENGINE 612 in MODEL 163 as of 1.9.02 / Printed on: 07.12.2019 / Page 4/4

D. W163 ML270 CDI wiring diagram for reference (OM612 engine)

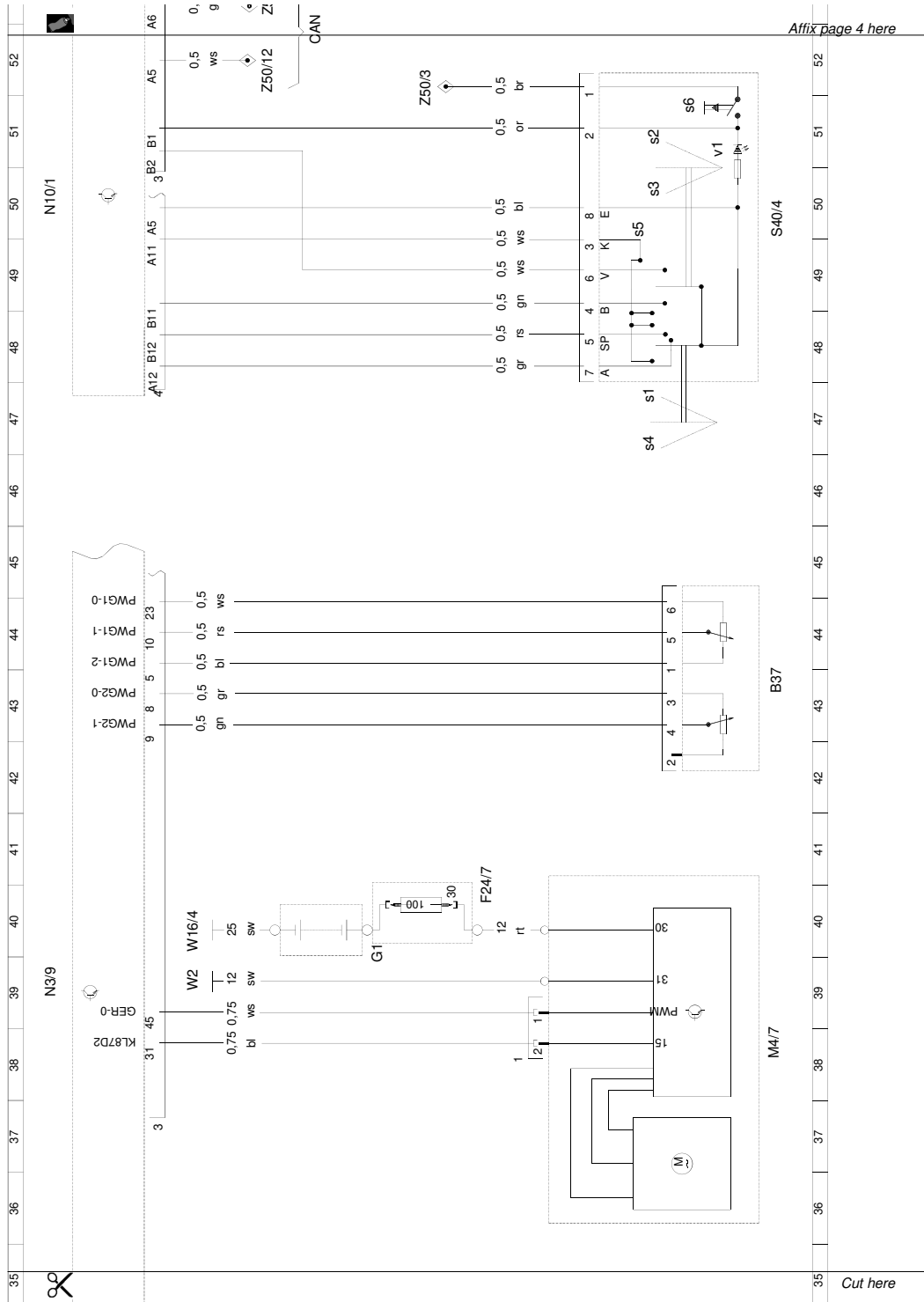

Affix page 4 here

Wiring diagram of common rail diesel injection (CDI) control unit / pe07.16-p-2000-99go  
ENGINE 612 in MODEL 163 as of 1.9.02 / Printed on: 07.12.2019 / Page 3/4

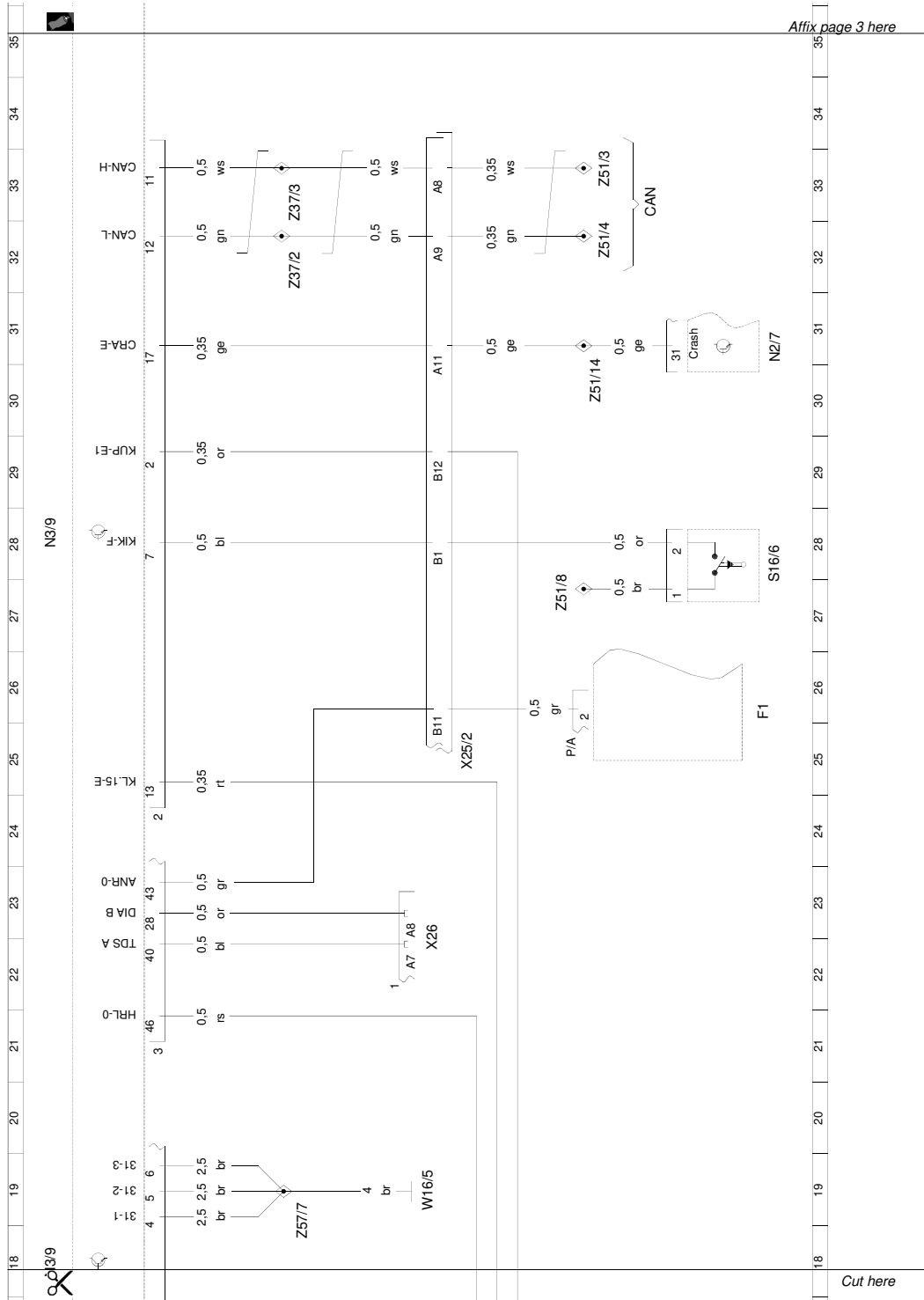

Wiring diagram of common rail diesel injection (CDI) control unit / pe07.16-p-2000-99go  
ENGINE 612 in MODEL 163 as of 1.9.02 / Printed on: 07.12.2019 / Page 2/4



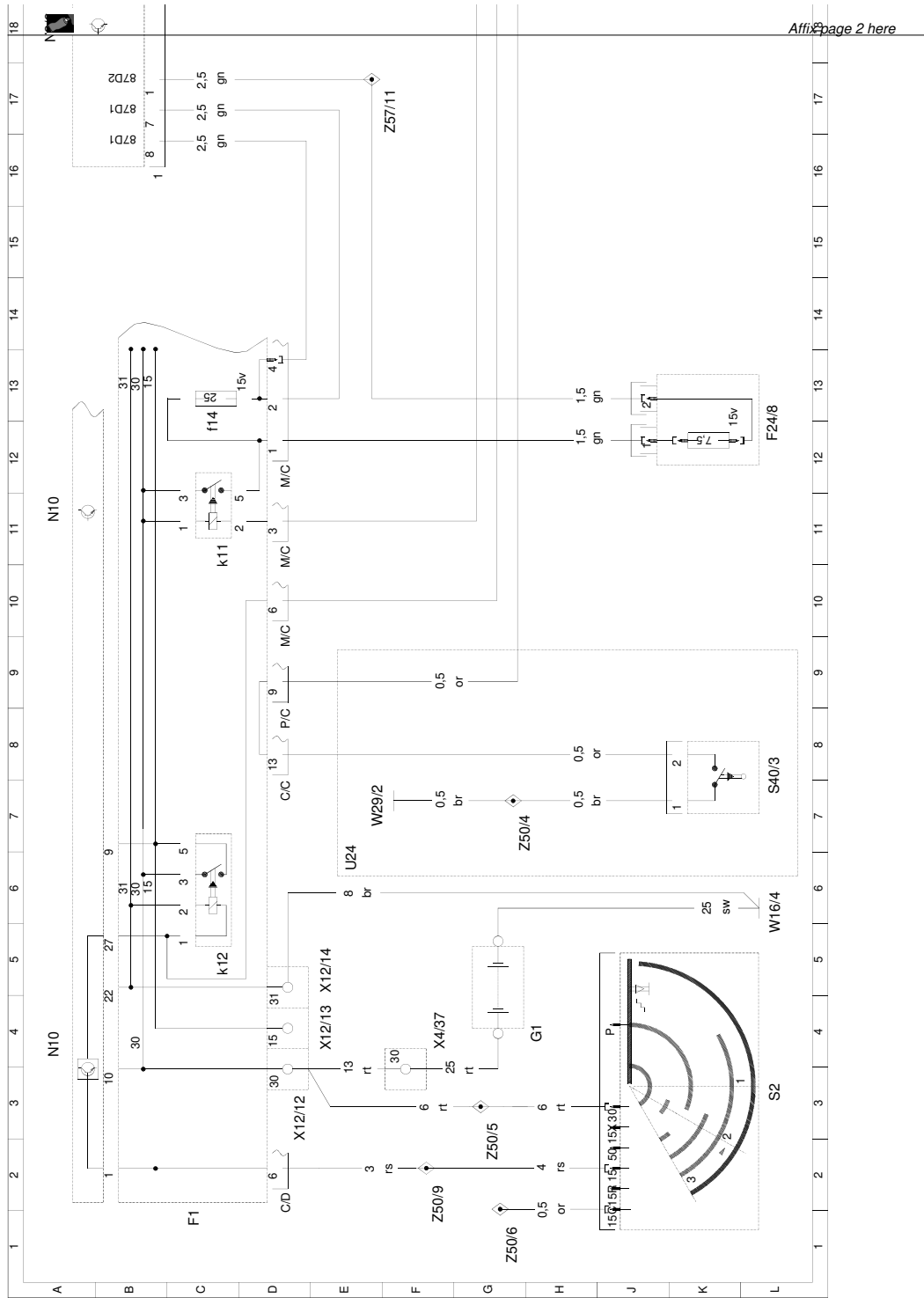

Wiring diagram of common rail diesel injection (CDI) control unit / pe07.16-p-2000-99go  
ENGINE 612 in MODEL 163 as of 1.9.02 / Printed on: 07.12.2019 / Page 1/4